

HRVATSKI  
GLASNIK  
INTELEKTUALNOG  
VLASNIŠTVA

6/2024

15. 3. 2024.

## SADRŽAJ - PATENTI

Objava prijava patenata	1
Kazalo brojeva prijava patenata	3
Kazalo klasifikacijskih oznaka prijava patenata prema MKP	4
Kazalo podnositelja prijava patenata	5
Objava zahtjeva za priznanje patenata provedbom postupka potpunog ispitivanja prijava patenata	6
Objava patenata	7
Kazalo brojeva patenata	8
Kazalo klasifikacijskih oznaka patenata prema MKP	9
Kazalo nositelja patenata	10
Objava prestanaka vrijednosti patenata/konsenzualnih patenata	11
Objava europskih patenata	12
Kazalo brojeva europskih patenata	36
Kazalo klasifikacijskih oznaka europskih patenata prema MKP	39
Kazalo nositelja europskih patenata	61
Objava izmijenjenih prijevoda europskih patenata	71
Kazalo brojeva izmijenjenih prijevoda europskih patenata	72
Kazalo klasifikacijskih oznaka izmijenjenih prijevoda europskih patenata prema MKP	73
Kazalo nositelja izmijenjenih prijevoda europskih patenata	74
Objava upisa promjena u registru patenata	75
Objava prestanaka vrijednosti europskih patenata	77
Objava proglašenja europskih patenata ništavim	72
Objava ispravaka podataka iz objavljenih europskih patenata	79
Objava podataka iz zahtjeva za izdavanje svjedodžbe	80
Kazalo proizvoda za koje je podnesen zahtjev za izdavanje svjedodžbi	81
Kazalo podnositelja zahtjeva za izdavanje svjedodžbi	82
Objava proglašenja svjedodžbi ništavima	83
Objava prestanaka vrijednosti svjedodžbi	84
Objava uporabnih modela	85
Kazalo brojeva uporabnih modela	86
Kazalo klasifikacijskih oznaka uporabnih modela prema MKP	87
Kazalo nositelja uporabnih modela	88

## **SADRŽAJ - ŽIGOVI**

Objava prijava žigova	1
Kazalo brojeva prijava žigova	18
Kazalo klasifikacijskih oznaka prijava žigova	19
Kazalo podnositelja prijava žigova	21
Objava upisa promjena u Registru prijava žigova	22
Objava informacija o međunarodnim registracijama žigova za koje je zatražena zaštita u Republici Hrvatskoj	23
Objava žigova	27
Kazalo brojeva žigova	47
Kazalo klasifikacijskih oznaka žigova	49
Kazalo nositelja žigova	52
Objava upisa promjena u Registru žigova	53
Objava ispravaka podataka iz objavljenih žigova	56
Objava produženja vrijednosti registracija žigova	57
Objava prestanka vrijednosti žigova	59

## **SADRŽAJ – INDUSTRIJSKA OBLIČJA/INDUSTRIJSKI DIZAJN**

Objava registracija industrijskog dizajna	1
Kazalo brojeva industrijskih dizajna	4
Kazalo klasifikacijskih oznaka industrijskih dizajna	5
Kazalo nositelja industrijskih dizajna	6
Objava produženja vrijednosti registriranih industrijskih dizajna	7
Objava prestanka vrijednosti priznatih prava	8
Informacije o objavama međunarodnih registracija industrijskog dizajna s učinkom u Republici Hrvatskoj	9

## **SADRŽAJ – ZASTUPNICI**

Objava podataka iz Registra zastupnika	1
--	---

# Objava prijava patenata

- (51) MKP (10) [HR P20221131 A1](#)  
**B01J 19/00** (2006.01)  
**A61M 5/00** (2006.01)
- (21) P20221131A (22) 14.09.2022.  
 (43) 15.03.2024.

(54) **AKTUATOR FOTOSINTEZE**  
**PHOTOSYNTHESIS ACTUATOR**

(71)(72) Stipan Orčić, Jurjenići 69, 51215 Kastav, HR

(57) Aktuator fotosinteze je samostalni i prenosivi električni uređaj, sa vlastitim izvorom el. energije i mogućnošću da se preko adaptera spoji na niskonaponsku mrežu. Kao djelomična alternativa hrani, ima svoj doprinos u očuvanju i zaštiti okoliša, smanjuje potrebu za komercijalnim uzgojem domaćih životinja i njihovim prerađevinama. Kod komercijalnog uzgoja životinja za prehranu, te industrijske proizvodnje mesa i mesnih proizvoda, koristi se mnogo energije, onečišćuju voda i zrak, proizvode se znatne količine stakleničkih plinova, kao što su ugljen-dioksid, metan i dr. koji stvaraju staklenički plin. Povećanjem uzgoja, raste i potražnja za povećanjem proizvodnje stočne hrane, što zahtjeva i povećanje obradivih površina na uštrb sječe šuma.

Takođe raste potreba za povećanjem proizvodnje stočne hrane, koja kao i proizvodnja žitarica, voća i povrća i njihova industrijska proizvodnja, ima veliki utjecaj na zagađenje okoliša. Razlog je povećana upotreba zaštitnih sredstava za usjeve, što dalje ima za posljedicu taloženja otrovnih supstanci u zemljište i njegovog zagađenja, a takođe dolazi do integracije otrovnih supstanci žitaricama, voću i povrću.

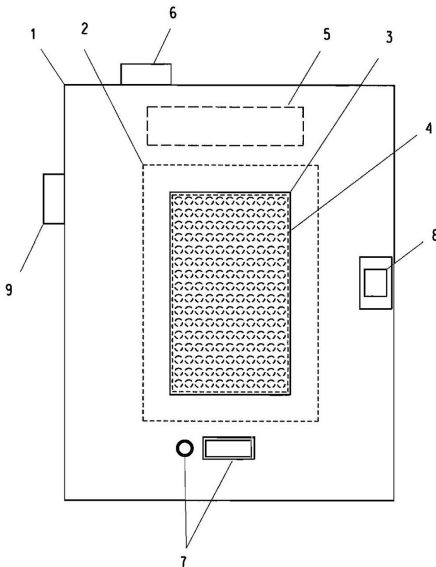

zračenja. Dva valjka u konstelaciji obuhvaćenoj ovim izumom na jedinstven način tvore tekuće ravnalo koje je u mogućnosti i od najviskoznijih foto smola napraviti materijal s kojim je moguća aditivna proizvodnja 3D modela. Primjenom ovog cjelovitog postupka omogućava se veća brzina izgradnje 3D modela (2), postiže se veća preciznost izgrađenih 3D modela (2) te u konačnici utječe na pojeftinjenje izrade 3D modela (2) izgrađenih na SLA, DLP i MSLA tehnologiji. Po ovom izumu, izgradnja je moguća u kontinuitetu, bez prestanka rada, sa konstantnom ponovljivošću izgrađenih 3D modela (2). I ono što naročito ističe prednost ovog izuma je mogućnost kvalitetne i precizne izgradnje 3D modela (2) neograničenih dimenzija.

Primjenom ovog izuma rješavaju se postojeći tehnički problemi kod izgradnje 3D modela (2) sa SLA, DLP i MSLA tehnologijom, a to su: kreiranje precizne površine tekućine / smole, a osobito se rješava problem izgradnje 3D modela sa visoko viskoznom smolama

Konačni rezultat primjene ovog izuma, a uzevši u obzir i rješavanje prisutnih tehničkih problema, je da izum omogućuje izgradnju 3D modela (2) brže, preciznije, jeftinije i moguće u neograničenim dimenzijama izgradnje 3D modela (2).

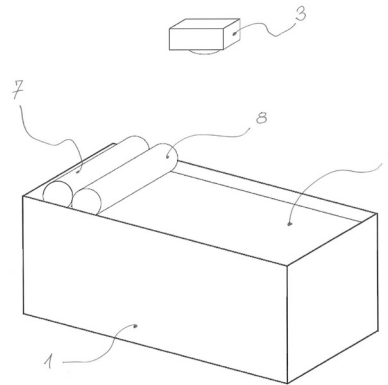

- (51) MKP (10) [HR P20231351 A1](#)  
**B61L 5/06** (2006.01)
- (21) P20231351A (22) 30.03.2022.  
 (43) 15.03.2024.  
 (86)PCT/CZ2022/050034; 30.03.2022.  
 (87) WO2022/207024; 06.10.2022.

(31) PV 2021-38699 (32) 01.04.2021. (33) CZ  
 (54) **SPAJANJE ELEKTROMOTORNE ŽELJEZNIČKE SKRETNICE S JEDNOFAZNIM ASINKRONIM MOTOROM S RADNIM KONDENZATOROM**  
**CONNECTION OF AN ELECTROMOTIVE POINT MACHINE WITH A SINGLE-PHASE ASYNCHRONOUS MOTOR WITH A RUN CAPACITOR**

(71) AŽD PRAHA S.R.O., Žirovnická 3146/2, 106 00 Praha 10 - Záběhlice, CZ

(72) Jiří Hlaváč, Miskovice 129, 28501 Miskovice, CZ

(74) Vukmir i suradnici odvjetničko društvo d.o.o., Zagreb, HR

(57) Spoj elektromotorne željezničke skretnice s jednofaznim asinkronim motorom s radnim kondenzatorom, pri čemu je motor (M) željezničke skretnice spojen preko svog prvog izvoda (U1) namota glavnog statora asinkronog motora željezničke skretnice na krug s dva kontaktora (Re1, Re2) i krug (K) s unutarnjim kontaktima željezničke skretnice, koji je spojen preko odgovarajućih unutarnjih kontakata (S1, S2) na odgovarajuće fazne dovodne vodiče (L1, L2) željezničke skretnice, gdje je drugi izvod (U2) namota glavnog statora motora (M) željezničke skretnice spojen na jedan pol kondenzatora (C) motora (M) željezničke skretnice i istovremeno na neutralni dovodni izvod (N) željezničke skretnice, gdje je drugi pol kondenzatora (C) motora (M) spojen na krug s dva kontaktora (Re1, Re2), gdje su izvodi (Z1, Z2) pomoćnog namota statora motora (M) željezničke skretnice pojedinačno spojeni na strujni

- (51) MKP (10) [HR P20221101 A1](#)  
**B29C 64/218** (2017.01)  
**B33Y 30/00** (2015.01)
- (21) P20221101A (22) 08.09.2022.  
 (43) 15.03.2024.

(54) **UREĐAJ ZA SEKVENCIJALNO NANOŠENJE TEKUĆINE KARAKTERIZIRANE PROIZVOLJNIM FAKTOROM VISKOZNOSTI U PROIZVOLJNO VISOKIM SLOJEVIMA**  
**A DEVICE FOR SEQUENTIAL APPLICATION, IN ARBITRARY HIGH LAYERS, OF LIQUID CHARACTERIZED BY AN ARBITRARY VISCOSITY**

(71) 3Dtech d.o.o., Ante Mike Tripala 5, 10090 Zagreb, HR

(72) Ljubomir Lokin, Ante Mike Tripala 5, 10000 Zagreb, HR  
 Luka Biondić, Ante Mike Tripala 5, 10090 Zagreb, HR

(57) Ovaj izum suštinski mijenja pripremu visoko viskoznih materijala, odnosno njihove površine, za polimerizaciju putem elektromagnetnog

krug s dva kontaktora (Re1, Re2) i na krug (K) s unutarnjim kontaktima željezničke skretnice, spojeni preko odgovarajućih unutarnjih kontakata (S1, S2) na odgovarajuće fazne dovodne vodiče (L1, L2) željezničke skretnice.

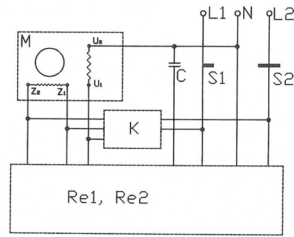

slučaju nestanka mrežnog napona i napajanja iz baterije, manje važna trošila će se ranije isključiti iz strujnog kruga. Uobičajeno se definiraju tri selektivne grupe.

(51) MKP (10) [HR P20221087 A1](#)  
**B62M 6/40** (2010.01)

(21) P20221087A (22) 02.09.2022.  
(43) 15.03.2024.

(54) **POGON BICIKLA SA LUČNIM MOTOROM**  
BICYCLE DRIVE WITH ARC MOTOR

(71)(72) Zdravko Crnjac, Dr. Franje Tuđmana 38a, 10437 Bestovje, HR

(57) Na vijlšku bicikla (sl.1) pričvršćena je ploča statora na kojoj su postavljeni namotaji (3) koji stvaraju aksijalni magnetni fluks koji kroz felgu (1) zatvara magnetni krug. Može biti jednostrani i dvostrani raspored ploča sa namotajima. Akumulirana struja iz akumulatora se preko konvertora pretvara u višefaznu struju sa faznim pomacima. Višefazna struja sa faznim pomacima stvara okretno magnetno polje to jest izmjenično lučno kretanje te zahvata permanentne magnetne ugrađene u felgu i tako pogoni bicikl. Put okretnog (lučnog) magnetnog polja se napravi više puta dok se felga sa permanentnim magnetima okrene jednom vršeci tako redukciju brzine.

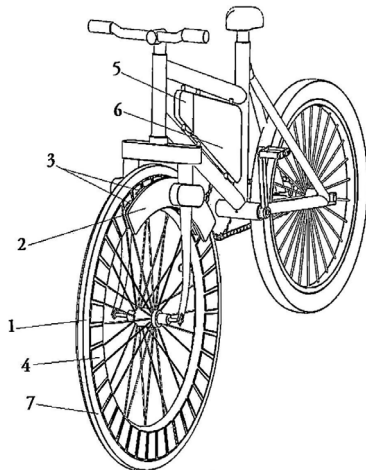

(51) MKP (10) [HR P20221069 A1](#)  
**H02J 9/06** (2006.01)

(21) P20221069A (22) 30.08.2022.  
(43) 15.03.2024.

(54) **INDUSTRIJSKI MODULARNI REDUNDANTNI VIŠEIZLAZNI**  
**SUSTAV NEPREKIDNOG NAPAJANJA ISTOSMJERNIM I**  
**IZMJENIČNIM NAPONIMA**

INDUSTRIAL MODULAR REDUNDANT MULTIPLE OUTPUT  
AC/DC UNINTERRUPTIBLE POWER SUPPLY

(71) MARETON d.o.o., Odranska ulica 1, 10000 Zagreb, HR

(72) Marko Štetić, Ulica Rude Bosaka 4, 10290 Zaprešić, HR

(74) PATENT PROJEKT d.o.o., Čakovec, HR

(57) Industrijski modularni redundantni višezlazni sustav neprekidnog napajanja istosmjernim i izmjeničnim naponima sadržava najmanje jedan elektro ormar u kojem se nalaze napajački uređaji, mjerno zaštitni uređaji i nadzorno komunikacijska jedinica pri čemu su ulazni naponi iz mreže ili drugog izvora napajanja 3x230/400 V, 50 Hz i/ili 230 V, 50 Hz i/ili 3x115 V, 60 Hz i/ili 4 x 400 V, 60 Hz i pri čemu su izlazni naponi 220 V i/ili 110 V i/ili 60 V i/ili 48 V i/ili 24 V i/ili 12 V. Posebnost kod ovog sustava je primjena selektivnih grupa radi toga što u nekom postrojenju koje se napaja ovim sustavom pojedina trošila su važnija od nekih drugih. Kako bi se sačuvala energija akumulatorske baterije za najvažnija trošila, u

# Kazalo brojeva prijave patenata

Broj prijave patenta	MKP
P20221069A	<b>H02J 9/06</b> (2006.01)
P20221087A	<b>B62M 6/40</b> (2010.01)
P20221101A	<b>B29C 64/218</b> (2017.01) <b>B33Y 30/00</b> (2015.01)

Broj prijave patenta	MKP
P20221131A	<b>B01J 19/00</b> (2006.01) <b>A61M 5/00</b> (2006.01)
P20231351A	<b>B61L 5/06</b> (2006.01)

# Kazalo klasifikacijskih oznaka prijave patenata prema Međunarodnoj klasifikaciji patenata

MKP (51)	Broj prijave patenta (21)	Naziv izuma (54)
<b>A61M 5/00</b> (2006.01)	P20221131A	AKTUATOR FOTOSINTEZE PHOTOSYNTHESIS ACTUATOR
<b>B01J 19/00</b> (2006.01)	P20221131A	AKTUATOR FOTOSINTEZE PHOTOSYNTHESIS ACTUATOR
<b>B29C 64/218</b> (2017.01)	P20221101A	UREĐAJ ZA SEKVENCIJALNO NANOŠENJE TEKUĆINE KARAKTERIZIRANE PROIZVOLJNIM FAKTOROM VISKOZNOSTI U PROIZVOLJNO VISOKIM SLOJEVIMA A DEVICE FOR SEQUENTIAL APPLICATION, IN ARBITRARY HIGH LAYERS, OF LIQUID CHARACTERIZED BY AN ARBITRARY VISCOSITY
<b>B33Y 30/00</b> (2015.01)	P20221101A	UREĐAJ ZA SEKVENCIJALNO NANOŠENJE TEKUĆINE KARAKTERIZIRANE PROIZVOLJNIM FAKTOROM VISKOZNOSTI U PROIZVOLJNO VISOKIM SLOJEVIMA A DEVICE FOR SEQUENTIAL APPLICATION, IN ARBITRARY HIGH LAYERS, OF LIQUID CHARACTERIZED BY AN ARBITRARY VISCOSITY
<b>B61L 5/06</b> (2006.01)	P20231351A	SPAJANJE ELEKTROMOTORNE ŽELJEZNIČKE SKRETNICE S JEDNOFAZNIM ASINKRONIM MOTOROM S RADNIM KONDENZATOROM CONNECTION OF AN ELECTROMOTIVE POINT MACHINE WITH A SINGLE-PHASE ASYNCHRONOUS MOTOR WITH A RUN CAPACITOR
<b>B62M 6/40</b> (2010.01)	P20221087A	POGON BICIKLA SA LUČNIM MOTOROM BICYCLE DRIVE WITH ARC MOTOR
<b>H02J 9/06</b> (2006.01)	P20221069A	INDUSTRIJSKI MODULARNI REDUNDANTNI VIŠEIZLAZNI SUSTAV NEPREKIDNOG NAPAJANJA ISTOSMJERNIM I IZMJENIČNIM NAPONIMA INDUSTRIAL MODULAR REDUNDANT MULTIPLE OUTPUT AC/DC UNINTERRUPTIBLE POWER SUPPLY

# Kazalo podnositelja prijava patenata

Podnositelj prijave patenta (71)	MKP (51)	Broj prijave patenta (21)	Naziv izuma (54)
3Dtech d.o.o., HR	<b>B29C 64/218</b> (2017.01) <b>B33Y 30/00</b> (2015.01)	P20221101A	UREĐAJ ZA SEKVENCIJALNO NANOŠENJE TEKUĆINE KARAKTERIZIRANE PROIZVOLJNIM FAKTOROM VISKOZNOSTI U PROIZVOLJNO VISOKIM SLOJEVIMA
AŽD PRAHA S.R.O., CZ	<b>B61L 5/06</b> (2006.01)	P20231351A	SPAJANJE ELEKTROMOTORNE ŽELJEZNIČKE SKRETNICE S JEDNOFAZNIM ASINKRONIM MOTOROM S RADNIM KONDENZATOROM
Crnjac, Zdravko, HR MARETON d.o.o., HR	<b>B62M 6/40</b> (2010.01) <b>H02J 9/06</b> (2006.01)	P20221087A P20221069A	POGON BICIKLA SA LUČNIM MOTOROM INDUSTRIJSKI MODULARNI REDUNDANTNI VIŠEIZLAZNI SUSTAV NEPREKIDNOG NAPAJANJA ISTOSMJERNIM I IZMJENIČNIM NAPONIMA
Orčić, Stipan, HR	<b>B01J 19/00</b> (2006.01) <b>A61M 5/00</b> (2006.01)	P20221131A	AKTUATOR FOTOSINTEZE



# Objava zahtjeva za priznanje patenata provedbom postupka potpunog ispitivanja prijava patenata

MKP	Broj prijave patenta	Datum podnošenja zahtjeva	Prijava objavljena u HGIV-u br.	Ime(na) podnosioca zahtjeva i prebivalište ili tvrtka i sjedište	Naziv izuma
(51)	(21)				(54)
<b>A47K 1/04</b> (2006.01)	P20220723A	26.02.2024	25/2023	EGORRA d.o.o., Varaždinska ulica 21, 42250 Lepoglava, HR	KUPAONSKI NAMJEŠTAJ - BAZA S UMIVAONIKOM
<b>B60C 11/00</b> (2006.01)	P20220267A	26.02.2024	18/2023	Mladen Ćuk, Zelinska 3, 10000 Zagreb, HR	PROTUKLIZNA TRAKA S PROFILOM KOJI ODGOVARA GUMI U KOJU SE UTISKUJE

# Objava patenata

---

- (51) MKP (10) [HR P20220213 B1](#)  
**B01F 23/234** (2022.01)  
**B01F 25/421** (2022.01)  
**B01F 25/30** (2022.01)  
**B01F 33/82** (2022.01)  
**C02F 3/26** (2023.01)
- (11) P20220213 (45) 15.03.2024.  
(21) P20220213A (22) 17.07.2020.  
(43) 19.08.2022.  
(86) PCT/PL2020/000063; 17.07.2020.  
(87) WO2021/015633; 28.01.2021.
- (31) P.430663 (32) 19.07.2019. (33) PL
- (54) **SUSTAV ZA ZASIĆENJE TEKUĆINA PLINOM I POSTUPAK ZA ZASIĆENJE TEKUĆINA PLINOM POMOĆU OVOG SUSTAVA**  
A SYSTEM FOR SATURATING LIQUIDS WITH GAS AND A METHOD FOR SATURATING LIQUIDS WITH GAS USING THIS SYSTEM
- (73) NET SPÓLKA Z ORGANIZACIÓNÁ ODPOWIEDZIALNOŚCIÁ  
WATER TECHNOLOGIES SPÓLKA  
KOMANDYTOWA, Ul. Sokolowska 38, 05-806 Sokolów, PL
- (72) Aleksander Widuch, Oskara Langego 2/105, 02-685 Warszawa, PL  
Filip Mariusz Herman, Ul. Jasnogórska 104/106 lok.32, 42-221 Częstochowa, PL
- (74) Źeljka Mrdeža, Rijeka, HR
-

# Kazalo brojeva patenata

Broj patenta (11)	MKP (51)
P20220213	<b>B01F 23/234</b> (2022.01) <b>B01F 25/421</b> (2022.01) <b>B01F 25/30</b> (2022.01) <b>B01F 33/82</b> (2022.01) <b>C02F 3/26</b> (2023.01)

# Kazalo klasifikacijskih oznaka patenata prema Međunarodnoj klasifikaciji patenata

MKP (51)	Broj konsenzualnog patenta (11)	Naziv izuma (54)
<b>B01F 23/234</b> (2022.01)	P20220213	SUSTAV ZA ZASIĆENJE TEKUĆINA PLINOM I POSTUPAK ZA ZASIĆENJE TEKUĆINA PLINOM POMOĆU OVOG SUSTAVA A SYSTEM FOR SATURATING LIQUIDS WITH GAS AND A METHOD FOR SATURATING LIQUIDS WITH GAS USING THIS SYSTEM
<b>B01F 25/30</b> (2022.01)	P20220213	SUSTAV ZA ZASIĆENJE TEKUĆINA PLINOM I POSTUPAK ZA ZASIĆENJE TEKUĆINA PLINOM POMOĆU OVOG SUSTAVA A SYSTEM FOR SATURATING LIQUIDS WITH GAS AND A METHOD FOR SATURATING LIQUIDS WITH GAS USING THIS SYSTEM
<b>B01F 25/421</b> (2022.01)	P20220213	SUSTAV ZA ZASIĆENJE TEKUĆINA PLINOM I POSTUPAK ZA ZASIĆENJE TEKUĆINA PLINOM POMOĆU OVOG SUSTAVA A SYSTEM FOR SATURATING LIQUIDS WITH GAS AND A METHOD FOR SATURATING LIQUIDS WITH GAS USING THIS SYSTEM
<b>B01F 33/82</b> (2022.01)	P20220213	SUSTAV ZA ZASIĆENJE TEKUĆINA PLINOM I POSTUPAK ZA ZASIĆENJE TEKUĆINA PLINOM POMOĆU OVOG SUSTAVA A SYSTEM FOR SATURATING LIQUIDS WITH GAS AND A METHOD FOR SATURATING LIQUIDS WITH GAS USING THIS SYSTEM
<b>C02F 3/26</b> (2023.01)	P20220213	SUSTAV ZA ZASIĆENJE TEKUĆINA PLINOM I POSTUPAK ZA ZASIĆENJE TEKUĆINA PLINOM POMOĆU OVOG SUSTAVA A SYSTEM FOR SATURATING LIQUIDS WITH GAS AND A METHOD FOR SATURATING LIQUIDS WITH GAS USING THIS SYSTEM

# Kazalo nositelja patenata

Nositelj konsenzualnog patenta (73)	MKP (51)	Broj konsenzualnog patenta (11)	Naziv izuma (54)
NET SPÓLKA Z ORGANIZACIÓNĄ ODPOWIEDZIALNOŚCIĄ WATER TECHNOLOGIES SPÓLKA KOMANDYTOWA, PL	<b>B01F 23/234</b> (2022.01) <b>B01F 25/421</b> (2022.01) <b>B01F 25/30</b> (2022.01) <b>B01F 33/82</b> (2022.01) <b>C02F 3/26</b> (2023.01)	P20220213	SUSTAV ZA ZASIĆENJE TEKUĆINA PLINOM I POSTUPAK ZA ZASIĆENJE TEKUĆINA PLINOM POMOĆU OVOG SUSTAVA

# Objava prestanka vrijednosti patenata/konsenzualnih patenata

Broj patenta (11)	MKP (51)	Datum prestanka vrijednosti patenta	Patent objavljen u HGIV-u br.	Naziv izuma (54)
PK20150851	<b>G09B 23/00</b> (2006.01)	11.08.2023	8/2018	VIŠENAMJENSKO UČILO ZA INTERPRETACIJU LIEBIGOVA ZAKONA

# Objava europskih патената

- (51) MKP (10) [HR P20231707 T1](#)  
**A01K 67/0278** (2024.01)  
**G01N 33/50** (2006.01)  
**C07K 14/705** (2006.01)  
**C07K 16/28** (2006.01)  
**A61P 35/00** (2006.01)  
**C07K 14/47** (2006.01)
- (11) P20231707 (46) 15.03.2024.  
(21) P20231707T (22) 22.12.2023.  
(96) [EP 20215046.2](#) 25.11.2015.  
(97) EP 3850946, 21.07.2021. 202129, En  
(97) EP 3850946, 27.09.2023. 202339, En  
(31) 201462087992 P (32) 05.12.2014. (33) US  
(62) 15813960.0 ; 25.11.2015.
- (54) **ŽIVOTINJE KOJE NISU LJUDI, KOJE SADRŽE HUMANIZIRANI GEN IZ DIFERENCIJACIJSKE SKUPINE 47**  
**NON-HUMAN ANIMALS HAVING A HUMANIZED CLUSTER OF DIFFERENTIATION 47 GENE**
- (73) Regeneron Pharmaceuticals, Inc., 777 Old Saw Mill River Road, Tarrytown, NY 10591-6707, US  
(72) Cagan Gurer, c/o Regeneron Pharmaceuticals Inc., 777 Old Saw Mill River Road, Tarrytown, NY 10591-6707, US  
Ella Ioffe, c/o Regeneron Pharmaceuticals Inc., 777 Old Saw Mill River Road, Tarrytown, NY 10591-6707, US  
Alexander Mujica, c/o Regeneron Pharmaceuticals Inc., 777 Old Saw Mill River Road, Tarrytown, NY 10591-6707, US  
Gavin Thurston, c/o Regeneron Pharmaceuticals Inc., 777 Old Saw Mill River Road, Tarrytown, NY 10591-6707, US  
(74) Tomislav Hadžija, Zagreb, HR
- 
- (51) MKP (10) [HR P20231594 T1](#)  
**A01K 67/033** (2006.01)  
**G05D 23/00** (2006.01)
- (11) P20231594 (46) 15.03.2024.  
(21) P20231594T (22) 06.12.2023.  
(86) PCT/PL2021050052 05.07.2021.  
(96) [EP 21807571.1](#) 05.07.2021.  
(87) [WO2021235958](#), 25.11.2021. , En  
(97) EP 3989720, 04.05.2022. 202218, En  
(97) EP 3989720, 04.10.2023. 202340, En  
(31) 43506320 (32) 24.08.2020. (33) PL
- (54) **PROIZVODNA LINIJA S PROTOČNIM SUSTAVOM GRIJANJA I/ILI HLAĐENJA HRANE I GRIJANOM POVRŠINOM ZA RAZMNOŽAVANJE I/ILI UZGOJ INSEKATA, METODA UZGOJA INSEKATA I NJENA UPOTREBA**  
**PRODUCTION LINE WITH FLOW-THROUGH FEED HEATING AND/OR COOLING SYSTEM AND HEATED SURFACE FOR BREEDING INSECTS, METHOD FOR BREEDING INSECTS AND USES THEREOF**
- (73) HiProMine S.A., ul. Poznanska 12F, 62-023 Robakowo, PL  
(72) Damian Józefiak, 62-023 Robakowo, PL  
Piotr Lubik, 60-162 Poznan, PL  
Krzysztof Dudek, 64-552 Sedziny, PL  
(74) FORINPRO d.o.o., Zagreb, HR
- 
- (51) MKP (10) [HR P20231595 T1](#)  
**A01K 67/033** (2006.01)  
**G05D 23/00** (2006.01)
- (11) P20231595 (46) 15.03.2024.  
(21) P20231595T (22) 06.12.2023.  
(86) PCT/PL2021050048 29.06.2021.  
(96) [EP 21809544.6](#) 29.06.2021.  
(87) [WO2021235957](#), 25.11.2021.  
(97) EP 3975709, 06.04.2022. 202214, En  
(97) EP 3975709, 04.10.2023. 202340, En  
(31) 43506420 (32) 24.08.2020. (33) PL
- 
- (54) **PROIZVODNA POVRŠINA SA SUSTAVOM PODNOG GRIJANJA I/ILI HLAĐENJA HRANE ZA INSEKTE, UPOTREBA PODNOG SUSTAVA I NAČIN UZGOJA INSEKATA POMOĆU NJEGA**  
**PRODUCTION SURFACE WITH SYSTEM OF UNDERFLOOR HEATING AND/OR COOLING OF INSECT FEED, USE OF UNDERFLOOR SYSTEM AND METHOD FOR REARING INSECTS USING THEREOF**
- (73) HiProMine S.A., ul. Poznanska 12F, 62-023 Robakowo, PL  
(72) Damian Józefiak, 62-023 Robakowo, PL  
Piotr Lubik, 60-162 Poznan, PL  
Krzysztof Dudek, 64-552 Sedziny, PL  
(74) FORINPRO d.o.o., Zagreb, HR
- 
- (51) MKP (10) [HR P20231633 T1](#)  
**A01N 25/28** (2006.01)  
**A01N 53/00** (2006.01)  
**A01P 7/04** (2006.01)
- (11) P20231633 (46) 15.03.2024.  
(21) P20231633T (22) 12.12.2023.  
(86) PCT/EP2017065541 23.06.2017.  
(96) [EP 17732136.1](#) 23.06.2017.  
(87) [WO2018001895](#), 04.01.2018. , En  
(97) EP 3478063, 08.05.2019. 201919, En  
(97) EP 3478063, 11.10.2023. 202341, En  
(31) 201611467 (32) 30.06.2016. (33) GB
- (54) **MIKROKAPSULE KOJE INKAPSULIRAJU LAMBDA-CIHALOTRIN**  
**MICROCAPSULES ENCAPSULATING LAMBDA-CYHALOTHRIN**
- (73) Syngenta Participations AG, Rosentalstrasse 67, 4058 Basel, CH  
(72) Kal Edly, Syngenta Crop Protection LLC, 410 Swing Road, Greensboro, NC 27409, US  
Matthew Robert Cottle, Syngenta Crop Protection LLC, 410 Swing Road, Greensboro, NC 27409, US  
(74) PRODUCTA d.o.o., Zagreb, HR
- 
- (51) MKP (10) [HR P20231662 T1](#)  
**A01N 31/06** (2006.01)  
**A01N 65/22** (2009.01)  
**A01N 25/04** (2006.01)  
**A01N 25/28** (2006.01)  
**A01P 17/00** (2006.01)
- (11) P20231662 (46) 15.03.2024.  
(21) P20231662T (22) 18.12.2023.  
(86) PCT/FR2016052065 11.08.2016.  
(96) [EP 16767324.3](#) 11.08.2016.  
(87) [WO2017032941](#), 02.03.2017.  
(97) EP 3340793, 04.07.2018. 201827, Fr  
(97) EP 3340793, 25.10.2023. 202343, Fr  
(31) 1557908 (32) 25.08.2015. (33) FR
- (54) **REPELENTNI PRIPRAVAK PROTIV INSEKATA PRENOSITELJIA TROPSKIH BOLESTI U OBLIKU SPREJA**  
**REPELLING SPRAY COMPOSITION AGAINST VECTOR INSECTS OF TROPICAL DISEASES**
- (73) Armonie Sante, 3 Impasse Léon Dierx, 97436 Saint-Leu, FR  
(72) David Tortillard, 3 Impasse Léon Dierx, 97436 Saint-Leu, FR  
(74) ZMP IP d.o.o., Zagreb, HR
- 
- (51) MKP (10) [HR P20231683 T1](#)  
**A01N 37/02** (2006.01)  
**A01N 47/36** (2006.01)  
**A01P 13/00** (2006.01)
- (11) P20231683 (46) 15.03.2024.  
(21) P20231683T (22) 20.12.2023.  
(86) PCT/EP2018078207 16.10.2018.  
(96) [EP 18783526.9](#) 16.10.2018.

- (87) [WO2019076878](#), 25.04.2019.  
 (97) EP 3697214, 26.08.2020. 202035, En  
 (97) EP 3697214, 27.09.2023. 202339, En  
 (31) 17196688 (32) 16.10.2017. (33) EP  
 (54) **SINERGIJSKI UČINKOVIT HERBICIDNI SASTAV KOJI SADRŽI PELARGONSKU KISELINU I FLAZASULFURON**  
**SYNERGISTICALLY EFFECTIVE HERBICIDE COMPOSITION COMPRISING PELARGONIC ACID AND FLAZASULFURON**  
 (73) Certis Belchim NV, Technologielaan 7, 1840 Londerzeel, BE  
 (72) Johan Desnoux, Technologielaan 7, 1840 Londerzeel, BE  
 Steven Van Pottelberge, Technologielaan 7, 1840 Londerzeel, BE  
 (74) Tomislav Hadžija, Zagreb, HR

- (51) MKP (10) [HR P20231649 T1](#)  
**A23C 19/028** (2006.01)  
**A23C 19/076** (2006.01)  
**A23C 19/02** (2006.01)  
**A23C 19/05** (2006.01)  
**A23C 9/142** (2006.01)  
 (11) P20231649 (46) 15.03.2024.  
 (21) P20231649T (22) 14.12.2023.  
 (86) PCT/NL2020050550 07.09.2020.  
 (96) [EP 20771368.6](#) 07.09.2020.  
 (87) [WO2021045624](#), 11.03.2021., En  
 (97) EP 4025061, 13.07.2022. 202228, En  
 (97) EP 4025061, 20.09.2023. 202338, En  
 (31) 19195715 (32) 05.09.2019. (33) EP  
 (54) **NAČIN IZRADE KOZJEG SIRA FRANCUSKOG TIP A**  
**METHOD OF MAKING FRENCH-TYPE GOAT CHEESE**  
 (73) Dairy Protein Cooperation Food B.V., Oud-Bodegraafseweg 14 c, 2411 HS Bodegraven, NL  
 (72) Bas Willem Maarten Lavrijsen, c/o Oud-Bodegraafseweg 14 c, 2411 HS Bodegraven, NL  
 Frédéric Benjamins, c/o Oud-Bodegraafseweg 14 c, 2411 HS Bodegraven, NL  
 (74) ZMP IP d.o.o., Zagreb, HR

- (51) MKP (10) [HR P20231648 T1](#)  
**A23L 7/109** (2016.01)  
**A23P 30/20** (2016.01)  
 (11) P20231648 (46) 15.03.2024.  
 (21) P20231648T (22) 14.12.2023.  
 (86) PCT/EP2020080355 29.10.2020.  
 (96) [EP 20796602.9](#) 29.10.2020.  
 (87) [WO2021083990](#), 06.05.2021., En  
 (97) EP 4051013, 07.09.2022. 202236, En  
 (97) EP 4051013, 18.10.2023. 202342, En  
 (31) 201900020048 (32) 30.10.2019. (33) IT  
 (54) **POSTUPAK ZA PROIZVODNJU PREHRAMBENOG PROIZVODA OD TJESTENINE EKSTRUZIJOM KROZ UMETAK NAPRAVLJEN OD POLIACETALNE SMOLE I SRODNI PROIZVOD**  
**PROCESS FOR THE PRODUCTION OF A PASTA FOOD PRODUCT BY EXTRUSION THROUGH AN INSERT MADE OF POLYACETAL RESIN AND RELATED PRODUCT**  
 (73) Barilla G. e R. Fratelli S.p.A., Via Mantova, 166, 43100 Parma, IT  
 (72) Francesco Panto', Via Rusino, 12, 43125 Parma, IT  
 Francesco Barba, Via Ernesto Devodier, 1, 43015 Noceto (PR), IT  
 Flavia Pizzabiocca, Via Altiero Spinelli, 12, 00053 Civitavecchia (RM), IT  
 Italo Bardiani, Via Giuseppe Rossi, 25, 43123 Parma, IT  
 Ugo Cesare Sottili, Via dei Combattenti, 2, 46010 Marcaria (MN), IT  
 Fabrizio Cassotta, Via Codazzi, 15, 26900 Lodi, IT  
 (74) ZMP IP d.o.o., Zagreb, HR

- (51) MKP (10) [HR P20231665 T1](#)  
**A24B 15/00** (2006.01)  
 (11) P20231665 (46) 15.03.2024.  
 (21) P20231665T (22) 18.12.2023.  
 (86) PCT/EP2019070730 31.07.2019.  
 (96) [EP 19755551.9](#) 31.07.2019.  
 (87) [WO2020025732](#), 06.02.2020.  
 (97) EP 3829338, 09.06.2021. 202123, En  
 (97) EP 3829338, 29.11.2023. 202348, En  
 (31) 201812503 (32) 31.07.2018. (33) GB  
 (54) **STVARANJE AEROSOLA**  
**AEROSOL GENERATION**

- (51) MKP (10) [HR P20231698 T1](#)  
**A24B 15/00** (2006.01)  
 (11) P20231698 (46) 15.03.2024.  
 (21) P20231698T (22) 21.12.2023.  
 (86) PCT/EP2019070727 31.07.2019.  
 (96) [EP 19755548.5](#) 31.07.2019.  
 (87) [WO2020025729](#), 06.02.2020., En  
 (97) EP 3829337, 09.06.2021. 202123, En  
 (97) EP 3829337, 29.11.2023. 202348, En  
 (31) 201812503 (32) 31.07.2018. (33) GB  
 (54) **GENERIRANJE AEROSOLA**  
**AEROSOL GENERATION**  
 (73) Nicoventures Trading Limited, Globe House, 1 Water Street, WC2R 3LA London, Greater London, GB  
 (72) Kav Ghanouni, c/o British American Tobacco (Investments) Limited, Globe House, 1 Water Street, WC2R 3LA London Greater London, GB  
 Jocelyn Benning, c/o British American Tobacco (Investments), Limited Globe House, 1 Water Street, WC2R 3LA London, Greater London, GB  
 Walid Abi Aoun, c/o British American Tobacco (Investments), Limited Globe House, 1 Water Street, WC2R 3LA London, Greater London, GB  
 (74) ZMP IP d.o.o., Zagreb, HR

- (51) MKP (10) [HR P20231696 T1](#)  
**A24F 40/42** (2020.01)  
**A61M 15/06** (2006.01)  
**A61M 11/04** (2006.01)  
**H02J 7/00** (2006.01)  
**A24F 40/90** (2020.01)  
**A24F 40/40** (2020.01)  
**A24F 40/50** (2020.01)  
**A24F 40/10** (2020.01)  
 (11) P20231696 (46) 15.03.2024.  
 (21) P20231696T (22) 21.12.2023.  
 (96) [EP 18201373.0](#) 14.03.2014.  
 (97) EP 3469934, 17.04.2019. 201916, En  
 (97) EP 3469934, 22.11.2023. 202347, En  
 (31) 201361903344 P (32) 12.11.2013. (33) US  
 201461937851 P 10.02.2014. US  
 (62) 14159709.6 ; 14.03.2014.  
 (54) **VAPORIZATOR**  
**VAPORIZER**  
 (73) VMR Products, LLC, 1000 F Street NW, Washington, DC, US  
 (72) Dan Recio, 1000 F Street NW, Washington DC, US  
 Yifeng Lu, 1000 F Street NW, Washington DC, US  
 Arturo Fajardo, 1000 F Street NW, Washington DC, US  
 Yinjun Zhang, 1000 F Street NW, Washington DC, US  
 Hans Verleur, 1000 F Street NW, Washington DC, US  
 Jan Andries Verleur, 1000 F Street NW, Washington DC, US  
 (74) ZMP IP d.o.o., Zagreb, HR

- (51) MKP (10) [HR P20231605 T1](#)  
**A24F 40/48** (2020.01)  
**A24F 40/485** (2020.01)  
**A24F 40/10** (2020.01)  
**A61M 15/00** (2006.01)  
**A61M 15/06** (2006.01)  
**A61M 11/04** (2006.01)  
**G01F 11/02** (2006.01)  
**G16H 20/13** (2018.01)  
 (11) P20231605 (46) 15.03.2024.  
 (21) P20231605T (22) 07.12.2023.  
 (86) PCT/US2019046951 16.08.2019.



- (96) [EP 19851878.9](#) 16.08.2019.  
 (87) [WO2020041151](#), 27.02.2020.  
 (97) EP 3840599, 30.06.2021. 202126, En  
 (97) EP 3840599, 11.10.2023. 202341, En  
 (31) 201862721699 P (32) 23.08.2018. (33) US  
 201916541062 14.08.2019. US  
 (54) **PATRONA I POSTUPAK ISPARAVANJA U SUSTAVU PATRONA S DIFUZOROM**  
 CARTRIDGE AND METHOD FOR VAPORIZING IN A CARTRIDGE SYSTEM WITH DIFFUSER  
 (73) Kaival Labs, Inc., 4460 Old Dixie Highway, Grant-Valkaria, FL 32949, US  
 (72) John Jesse Woodbine, 321 Wisteria Way, Lafayette, CO 80026, US  
 Joseph Francis Keenan, 362 Amethyst Way, Superior, CO 80027, US  
 (74) Hraste & Partneri odvjetničko društvo d.o.o., Zagreb, HR

- (51) MKP (10) [HR P20231647 T1](#)  
**A41D 19/00** (2006.01)  
**A41D 19/015** (2006.01)  
**A41D 19/02** (2006.01)  
**B29D 99/00** (2010.01)  
 (11) P20231647 (46) 15.03.2024.  
 (21) P20231647T (22) 14.12.2023.  
 (86) PCT/CN2018071895 09.01.2018.  
 (96) [EP 18739261.8](#) 09.01.2018.  
 (87) [WO2018130138](#), 19.07.2018. , Zh  
 (97) EP 3569083, 20.11.2019. 201947, En  
 (97) EP 3569083, 27.09.2023. 202339, En  
 (31) 201710020727 (32) 12.01.2017. (33) CN  
 (54) **STRUKTURA RUKAVICE**  
 GLOVE STRUCTURE  
 (73) JOHN ENGINE SPORTS PRODUCTS INC, 2F., No. 13 Building, Jinjiao Office Park, Pudong, 201206 Shanghai, CN  
 (72) Wenlan Cai, 2F. No. 13 Building Jinjiao Office Park No. 27 Xinjinjiao Road Pudong, 201206 Shanghai, CN  
 Jinfeng Li, 2F. No. 13 Building Jinjiao Office Park No. 27 Xinjinjiao Road Pudong, 201206 Shanghai, CN  
 Zhibin Li, 2F. No. 13 Building Jinjiao Office Park No. 27 Xinjinjiao Road Pudong, 201206 Shanghai, CN  
 (74) FORINPRO d.o.o., Zagreb, HR

- (51) MKP (10) [HR P20231646 T1](#)  
**A45D 24/30** (2006.01)  
 (11) P20231646 (46) 15.03.2024.  
 (21) P20231646T (22) 13.12.2023.  
 (86) PCT/ES2017070514 14.07.2017.  
 (96) [EP 17917520.3](#) 14.07.2017.  
 (87) [WO2019012165](#), 17.01.2019. , Es  
 (97) EP 3653080, 20.05.2020. 202021, En  
 (97) EP 3653080, 25.10.2023. 202343, En  
 (54) **ČEŠALJ ZA LIJEČENJE PEDIKULOZE**  
 COMB FOR THE TREATMENT OF PEDICULOSIS  
 (73) Lacuna S.A., Paraguay 1246, 11100 Montevideo, UY  
 (72) Jorge Reinaldo Burchakchi, Paraguay 1246, 11100 Montevideo, UY  
 Juan Martin Sanz, Paraguay 1246, 11100 Montevideo, UY  
 (74) ZMP IP d.o.o., Zagreb, HR

- (51) MKP (10) [HR P20231659 T1](#)  
**A61B 17/00** (2006.01)  
**A44C 7/00** (2006.01)  
 (11) P20231659 (46) 15.03.2024.  
 (21) P20231659T (22) 15.12.2023.  
 (86) PCT/US2017047942 22.08.2017.  
 (96) [EP 17762272.7](#) 22.08.2017.  
 (87) [WO2018039189](#), 01.03.2018.  
 (97) EP 3503812, 03.07.2019. 201927, En  
 (97) EP 3503812, 04.10.2023. 202340, En  
 (31) 201662378638 P (32) 23.08.2016. (33) US  
 201615276609 26.09.2016. US  
 (54) **JEDNOKRATNI RUČNI ULOŽAK INSTRUMENTA ZA PROBIJANJE TIJELA**  
 DISPOSABLE HAND OPERATED CARTRIDGE BODY PIERCING INSTRUMENT  
 (73)(72) Goran Reil, 521 W. Rosecrans Avenue, Gardena, CA 90248, US  
 Vladimir Reil, 521 W. Rosecrans Avenue, Gardena, CA 90248, US  
 (74) Tomislav Hadžija, Zagreb, HR

- (51) MKP (10) [HR P20231632 T1](#)  
**A61F 2/12** (2006.01)  
**A61F 2/00** (2006.01)  
 (11) P20231632 (46) 15.03.2024.  
 (21) P20231632T (22) 12.12.2023.  
 (86) PCT/IT2020050188 28.07.2020.  
 (96) [EP 20765373.4](#) 28.07.2020.  
 (87) [WO2021024284](#), 11.02.2021.  
 (97) EP 4009904, 15.06.2022. 202224, En  
 (97) EP 4009904, 13.09.2023. 202337, En  
 (31) 201900014193 (32) 08.08.2019. (33) IT  
 (54) **UREĐAJ ZA POHRANU, NAMIJENJEN ZA PROTEZU DOJKE PRILIKOM REKONSTRUKTIVNE KIRURGIJE DOJKE**  
 CONTAINER DEVICE FOR BREAST PROSTHESIS FOR RECONSTRUCTIVE BREAST SURGERY  
 (73) DECO MED SRL, Via delle industrie 2/4, 30020 Marcon (VE), IT  
 (72) Giovanni Bertoli, Via delle Industrie 2/4, 30020 Marcon (VE), IT  
 (74) Hraste & Partneri odvjetničko društvo d.o.o., Zagreb, HR

- (51) MKP (10) [HR P20231703 T1](#)  
**A61F 7/10** (2006.01)  
**A61C 19/06** (2006.01)  
**A61C 19/08** (2006.01)  
**A61F 7/12** (2006.01)  
**A61C 1/00** (2006.01)  
**A61F 7/00** (2006.01)  
**A61F 7/02** (2006.01)  
 (11) P20231703 (46) 15.03.2024.  
 (21) P20231703T (22) 21.12.2023.  
 (86) PCT/US2019014237 18.01.2019.  
 (96) [EP 19704129.6](#) 18.01.2019.  
 (87) [WO2019143968](#), 25.07.2019.  
 (97) EP 3740174, 25.11.2020. 202048, En  
 (97) EP 3740174, 25.10.2023. 202343, En  
 (31) 201815875395 (32) 19.01.2018. (33) US  
 (54) **USNIK ZA HLADENJE TKIVA USNE ŠUPLJINE**  
 MOUTH PIECE FOR COOLING OF ORAL TISSUE  
 (73) ChemoMouthpiece, LLC, 10 Railroad Avenue, Closter, NJ 07624, US  
 (72) David Yoskowitz, 24 Hunter Ridge, Woodcliff Lake, NJ 07677, US  
 (74) PETOŠEVIĆ d.o.o., Zagreb, HR

- (51) MKP (10) [HR P20231641 T1](#)  
**A61K 31/03** (2006.01)  
**A61K 9/107** (2006.01)  
**A61K 9/16** (2006.01)  
**A61P 35/00** (2006.01)  
**A61K 9/14** (2006.01)  
 (11) P20231641 (46) 15.03.2024.  
 (21) P20231641T (22) 13.12.2023.  
 (86) PCT/IB2020059218 01.10.2020.  
 (96) [EP 20786346.5](#) 01.10.2020.  
 (87) [WO2021084345](#), 06.05.2021.  
 (97) EP 4051249, 07.09.2022. 202236, Fr  
 (97) EP 4051249, 13.09.2023. 202337, Fr  
 (31) 1912084 (32) 28.10.2019. (33) FR  
 (54) **FARMACEUTSKI PRIPRAVAK KOJI SADRŽI MITOTAN ZA ORALNU PRIMJENU ZA LIJEČENJE ADRENOKORTIKALNOG KARCINOMA I CUSHINGOVOG SINDROMA**  
 PHARMACEUTICAL COMPOSITION COMPRISING MITOTANE FOR ORAL ADMINISTRATION FOR USE IN THE TREATMENT OF ADRENOCORTICAL CARCINOMA AND CUSHING-SYNDROME  
 (73) Mohamed Skiba, 3205 Route de Lyons, 76520 Montmain, FR  
 (72) Malika Lahiani-Skiba, 3205 route de Lyons, 76520 Montmain, FR  
 Frédéric Bounoure, 137, Allée des Halliers, 76230 Bois Guillaume, FR  
 Michael Thomas, 2 Parc du Lyons, 76130 Mont-Saint-Aignan, FR  
 Hervé Lefebvre, 1111 Rue des Long Vallon, 76960 N-D de Bondeville, FR  
 Mohamed Skiba, 3205 Route de Lyons, 76520 Montmain, FR  
 (74) Tomislav Hadžija, Zagreb, HR

- (51) MKP (10) [HR P20231584 T1](#)  
**A61K 31/04** (2006.01)

- A61K 31/202** (2006.01)  
**A61K 31/375** (2006.01)  
**A61K 31/7068** (2006.01)  
**A61K 31/7072** (2006.01)  
**A61P 25/28** (2006.01)  
**A61P 3/02** (2006.01)
- (11) P20231584 (46) 15.03.2024.  
(21) P20231584T (22) 05.12.2023.
- (86) PCT/NL2017050140 08.03.2017.  
(96) [EP 17716066.0](#) 08.03.2017.  
(87) [WO2017155395](#), 14.09.2017.  
(97) EP 3426236, 16.01.2019. 201903, En  
(97) EP 3426236, 04.10.2023. 202340, En
- (31) PCT/NL2016/050161 (32) 08.03.2016. (33) WO
- (54) **POSTUPAK ZA PODRŠKU MEMORIJSKOJ FUNKCIJI I/ILI KOGNITIVNOJ FUNKCIJI**  
**METHOD FOR SUPPORTING MEMORY FUNCTION AND/OR COGNITIVE FUNCTION**
- (73) N.V. Nutricia, Eerste Stationsstraat 186, 2712 HM Zoetermeer, NL  
(72) Mattheus Cornelis De Wilde, Uppsalsalaan 12, 3584 CT Utrecht, NL  
(74) ZMP IP d.o.o., Zagreb, HR

- (51) MKP (10) [HR P20231735 T1](#)
- A61K 31/137** (2006.01)  
**A61P 15/00** (2006.01)  
**A61P 25/00** (2006.01)
- (11) P20231735 (46) 15.03.2024.  
(21) P20231735T (22) 28.12.2023.
- (86) PCT/IB2020057967 26.08.2020.  
(96) [EP 20772102.8](#) 26.08.2020.  
(87) [WO2021038460](#), 04.03.2021.  
(97) EP 4021433, 06.07.2022. 202227, En  
(97) EP 4021433, 04.10.2023. 202340, En
- (31) 201962891438 P (32) 26.08.2019. (33) US
- (54) **LJEČENJE SIMPTOMA IZAZVANIH MENSTRUALNIM CIKLUSOM**  
**TREATMENT OF MENSTRUAL CYCLE-INDUCED SYMPTOMS**
- (73) Period Pill BV, Nes 116, 1012 KE Amsterdam, NL  
(72) Merel Janssen, Rijksstraatweg 163, 1396 JK Baambrugge, NL  
Edgar Stijn Jochem Janssen, Rijksstraatweg 163, 1396 JK Baambrugge, NL  
Ezekiel Golan, 1120 Ironwork Passage, False Creek, Vancouver, BC, CA  
(74) Tomislav Hadžija, Zagreb, HR

- (51) MKP (10) [HR P20231572 T1](#)
- A61K 31/198** (2006.01)  
**A61K 31/205** (2006.01)  
**A61K 45/06** (2006.01)  
**A61K 31/277** (2006.01)  
**A61P 3/02** (2006.01)  
**A61P 3/04** (2006.01)  
**A61P 3/06** (2006.01)  
**A61P 3/08** (2006.01)  
**A61P 3/10** (2006.01)
- (11) P20231572 (46) 15.03.2024.  
(21) P20231572T (22) 04.12.2023.
- (86) PCT/US2015039075 02.07.2015.  
(96) [EP 15815585.3](#) 02.07.2015.  
(87) [WO2016004363](#), 07.01.2016.  
(97) EP 3164125, 10.05.2017. 201719, En  
(97) EP 3164125, 06.09.2023. 202336, En
- (31) 201462020797 P (32) 03.07.2014. (33) US  
201562127111 P 02.03.2015. US
- (54) **POSTUPCI I PRIPRAVKI ZA LIJEČENJE PRETILOSTI, SPREČAVANJE DOBIVANJA NA TEŽINI, PROMICANJE GUBITKA TEŽINE, PROMICANJE MRŠAVLJENJA, ILI LIJEČENJE ILI PREVENCIJU RAZVOJA DIJABETESA**  
**METHODS AND COMPOSITIONS FOR TREATING OBESITY, PREVENTING WEIGHT GAIN, PROMOTING WEIGHT LOSS, PROMOTING SLIMMING, OR TREATING OR PREVENTING THE DEVELOPMENT OF DIABETES**
- (73) Silti AG, c/o Transforma AG, Gartenstrasse 4, 6300 Zug, CH  
(72) Gabriel Gojon-Zorrilla, Lomas del Sol 649 Colonia Lomas del Campestre, 66278 San Pedro Garza Garcia, MX  
Gabriel Gojon-Romanillos, Rio Madeira 511 Colonia del Valle, 66220 San Pedro Garza Garcia, MX  
(74) Vukmir i suradnici odvjjetničko društvo d.o.o., Zagreb, HR

- (51) MKP (10) [HR P20231576 T1](#)
- A61K 31/221** (2006.01)  
**A61K 31/222** (2006.01)  
**A61K 31/223** (2006.01)  
**A61K 31/225** (2006.01)  
**A61K 31/255** (2006.01)  
**A61P 25/28** (2006.01)  
**G01N 33/50** (2006.01)  
**G01N 33/52** (2006.01)

- (11) P20231576 (46) 15.03.2024.  
(21) P20231576T (22) 04.12.2023.
- (86) PCT/US2019044114 30.07.2019.  
(96) [EP 19752609.8](#) 30.07.2019.  
(87) [WO2020028348](#), 06.02.2020.  
(97) EP 3829568, 09.06.2021. 202123, En  
(97) EP 3829568, 06.09.2023. 202336, En
- (31) 201862713056 P (32) 01.08.2018. (33) US
- (54) **DERIVATI SULFOPROPANSKE KISELINE ZA LIJEČENJE NEURODEGENERATIVNIH POREMEĆAJA**  
**SULFOPROPANOIC ACID DERIVATIVES FOR TREATING NEURODEGENERATIVE DISORDERS**
- (73) Alzheon, Inc., 111 Speen Street, Framingham, MA 01701, US  
(72) Petr Kocis, 111 Speen Street, Suite 306, Framingham, MA 01701, US  
John Hey, 111 Speen Street, Suite 306, Framingham, MA 01701, US  
Martin Tolar, 111 Speen Street, Suite 306, Framingham, MA 01701, US  
(74) Tomislav Hadžija, Zagreb, HR

- (51) MKP (10) [HR P20231691 T1](#)
- A61K 31/353** (2006.01)  
**A61K 9/20** (2006.01)  
**A61K 9/28** (2006.01)  
**A61K 36/45** (2006.01)  
**A61P 1/00** (2006.01)  
**A61P 1/04** (2006.01)
- (11) P20231691 (46) 15.03.2024.  
(21) P20231691T (22) 21.12.2023.
- (86) PCT/IB2017057580 01.12.2017.  
(96) [EP 17822783.1](#) 01.12.2017.  
(87) [WO2018100551](#), 07.06.2018.  
(97) EP 3548006, 09.10.2019. 201941, En  
(97) EP 3548006, 15.11.2023. 202346, En
- (31) 201600122310 (32) 01.12.2016. (33) IT
- (54) **PRIPRAVAK ZA UPOTREBU U LIJEČENJU PROMJENA U CRIJEVIMA**  
**COMPOSITION FOR USE IN THE TREATMENT OF INTESTINAL ALTERATIONS**
- (73) Alfaisigma S.p.A., Via Ragazzi del 99, 5, 40133 Bologna, IT  
(72) Andrea Biffi, 20060 Trezzano Rosa (MI), IT  
Ruggero Rossi, 20060 Trezzano Rosa (MI), IT  
Walter Fiore, 20060 Trezzano Rosa (MI), IT  
Silvia Salamina, 20060 Trezzano Rosa (MI), IT  
(74) Danija Budimir, Zagreb, HR

- (51) MKP (10) [HR P20231163 T1](#)
- A61K 31/404** (2006.01)  
**A61K 31/66** (2006.01)  
**A61K 31/7076** (2006.01)  
**A61P 35/00** (2006.01)  
**C07C 227/14** (2006.01)  
**C07D 209/10** (2006.01)  
**C07D 317/40** (2006.01)  
**C07F 9/06** (2006.01)
- (11) P20231163 (46) 15.03.2024.  
(21) P20231163T (22) 26.09.2023.
- (86) PCT/US2016044767 29.07.2016.  
(96) [EP 16833623.8](#) 29.07.2016.  
(87) [WO2017023774](#), 09.02.2017.  
(97) EP 3328827, 06.06.2018. 201823, En  
(97) EP 3328827, 05.07.2023. 202327, En
- (31) 201562199566 P (32) 31.07.2015. (33) US
- (54) **PROLIJEKOVI GLUTAMINSKIH ANALOGA**  
**PRODRUGS OF GLUTAMINE ANALOGS**
- (73) The Johns Hopkins University, 3400 North Charles Street, Baltimore, MD 21218, US  
Institute Of Organic Chemistry and Biochemistry AS CR, V.V.I., Flemingovo namesti 542/2, 166 10 Praha 6, CZ

(72)	Barbara Slusher, 7424 Longfield Dr., Kingsville, MD 21087, US Rana Rais, 12905 Vistaview Dr., West Friendship, MD 21794, US Lukas Tenora, Flemingovo Nám. 2, 166 10 Praha 6, CZ Pavel Majer, 6201 Long Meadow Dr., Sykesville, MD 21784, US Andrej Jancarik, Pod Moravii 1315, 74221 Koprivnice, CZ	(74)	Hraste & Partneri odvjetničko društvo d.o.o., Zagreb, HR
(74)	ZMP IP d.o.o., Zagreb, HR		
<hr/>			
(51)	MKP (10) <b>HR P20231706 T1</b> <b>A61K 31/4402</b> (2006.01) <b>A61P 27/16</b> (2006.01) <b>A61K 47/32</b> (2006.01) <b>A61K 9/08</b> (2006.01)		
(11)	P20231706 (46) 15.03.2024.		
(21)	P20231706T (22) 22.12.2023.		
(96)	<a href="#">EP 20170448.3</a> 02.02.2018.		
(97)	EP 3698791, 26.08.2020. 202035, En		
(97)	EP 3698791, 25.10.2023. 202343, En		
(31)	201762453931 P (32) 02.02.2017. (33) US		
(62)	18703749.4 ; 02.02.2018.		
(54)	<b>INTRANAZALNI PRIPRAVAK KOJI SADRŽI BETAHISTIN</b> <b>INTRANASAL COMPOSITION COMPRISING BETAHISTINE</b>		
(73)	Otolanum AG, Bahnhofstrasse 21, 6300 Zug, CH		
(72)	Christopher John Wraight, 25 Eustace Street, 3130 Blackburn, VI, AU Thomas Meyer, Birkenweg 6, 4528 Zuchwil, CH		
(74)	PRODUCTA d.o.o., Zagreb, HR		
<hr/>			
(51)	MKP (10) <b>HR P20231586 T1</b> <b>A61K 31/4439</b> (2006.01) <b>C07D 405/14</b> (2006.01) <b>A61P 3/10</b> (2006.01)		
(11)	P20231586 (46) 15.03.2024.		
(21)	P20231586T (22) 05.12.2023.		
(86)	PCT/US2020038617 19.06.2020.		
(96)	<a href="#">EP 20739523.7</a> 19.06.2020.		
(87)	<a href="#">WO2020263695</a> , 30.12.2020. , En		
(97)	EP 3989972, 04.05.2022. 202218, En		
(97)	EP 3989972, 08.11.2023. 202345, En		
(31)	201962868117 P (32) 28.06.2019. (33) US 201962904906 P 24.09.2019. US		
(54)	<b>AGONISTI RECEPTORA GLUKAGONU SLIČNONG PEPTIDA 1</b> <b>GLUCAGON-LIKE PEPTIDE 1 RECEPTOR AGONISTS</b>		
(73)	ELI LILLY AND COMPANY, Lilly Corporate Center, Indianapolis, IN 46206-6288, US		
(72)	David Andrew Coates, c/o Eli Lilly and Company, P.O. Box 6288, Indianapolis, IN 46206-6288, US Todd Fields, c/o Eli Lilly and Company P. O. Box 6288, Indianapolis, IN 46206-6288, US Joseph Daniel Ho, c/o Eli Lilly and Company, P.O. Box 6288, Indianapolis, IN 46206-6288, US Fucheng Qu, c/o Eli Lilly and Company, P.O. Box 6288, Indianapolis, IN 46206-6288, US		
(74)	Hraste & Partneri odvjetničko društvo d.o.o., Zagreb, HR		
<hr/>			
(51)	MKP (10) <b>HR P20231587 T1</b> <b>A61K 31/444</b> (2006.01) <b>A61P 25/06</b> (2006.01)		
(11)	P20231587 (46) 15.03.2024.		
(21)	P20231587T (22) 05.12.2023.		
(86)	PCT/US2019049340 03.09.2019.		
(96)	<a href="#">EP 19773583.0</a> 03.09.2019.		
(87)	<a href="#">WO2020051137</a> , 12.03.2020. , En		
(97)	EP 3846810, 14.07.2021. 202128, En		
(97)	EP 3846810, 18.10.2023. 202342, En		
(31)	201862726585 P (32) 04.09.2018. (33) US		
(54)	<b>KRONIČNO NOĆNO DOZIRANJE LASMIDITANA RADI</b> <b>SPRJEČAVANJA MIGRENE</b> <b>CHRONIC NIGHTLY DOSING OF LASMIDITAN FOR MIGRAINE PREVENTION</b>		
(73)	Eli Lilly and Company, Lilly Corporate Center, Indianapolis, IN 46285, US		
(72)	Robert Russell Conley, c/o ELI LILLY AND COMPANY, P.O. Box 6288, Indianapolis, IN 46206-6288, US Gudarz Davar, c/o ELI LILLY AND COMPANY, P.O. Box 6288, Indianapolis, IN 46206-6288, US Kirk Willis Johnson, c/o ELI LILLY AND COMPANY, P.O. Box 6288, Indianapolis, IN 46206-6288, US		
<hr/>			
(51)	MKP (10) <b>HR P20231568 T1</b> <b>A61K 31/4545</b> (2006.01) <b>C07D 401/12</b> (2006.01) <b>A61P 3/00</b> (2006.01) <b>A61P 3/10</b> (2006.01) <b>A61P 25/16</b> (2006.01) <b>A61P 25/08</b> (2006.01) <b>A61P 25/32</b> (2006.01) <b>A61P 25/24</b> (2006.01) <b>A61P 25/00</b> (2006.01) <b>A61P 43/00</b> (2006.01)		
(11)	P20231568 (46) 15.03.2024.		
(21)	P20231568T (22) 04.12.2023.		
(86)	PCT/EP2018057215 21.03.2018.		
(96)	<a href="#">EP 18714194.0</a> 21.03.2018.		
(87)	<a href="#">WO2018172432</a> , 27.09.2018.		
(97)	EP 3600315, 05.02.2020. 202006, En		
(97)	EP 3600315, 06.09.2023. 202336, En		
(31)	17305309 (32) 21.03.2017. (33) EP		
(54)	<b>NOVA TERAPIJSKA UPOTREBA H3-LIGANADA</b> <b>NEW THERAPEUTICAL USE OF H3-LIGANDS</b>		
(73)	BIOPROJET Pharma, 9 rue Rameau, 75002 Paris, FR		
(72)	Jeanne-Marie Lecomte, 30 rue des Francs-Bourgeois, 75003 Paris, FR Jean-Charles Schwartz, 9 villa Seurat, 75014 Paris, FR Olivier Labeeuw, 7 rue Julien Gracq, 35300 Fougeres, FR Marc Capet, Les Petites Rivières, 35520 Melesse, FR		
(74)	PRODUCTA d.o.o., Zagreb, HR		
<hr/>			
(51)	MKP (10) <b>HR P20231588 T1</b> <b>A61K 31/47</b> (2006.01) <b>A61P 31/18</b> (2006.01) <b>C07D 215/56</b> (2006.01)		
(11)	P20231588 (46) 15.03.2024.		
(21)	P20231588T (22) 05.12.2023.		
(96)	<a href="#">EP 17186674.2</a> 19.05.2005.		
(97)	EP 3281939, 14.02.2018. 201807, En		
(97)	EP 3281939, 18.10.2023. 202342, En		
(31)	2004150979 (32) 20.05.2004. (33) JP		
(62)	05726243.8 ; 19.05.2005.		
(54)	<b>KOMBINACIJA KOJA SADRŽI STABILNI KRISTAL 4-OXSOKINOLINSKOG SPOJA</b> <b>COMBINATION COMPRISING A STABLE CRYSTAL OF A 4-OXOQUINOLINE COMPOUND</b>		
(73)	Japan Tobacco, Inc., 1-1, Toranomon 4-chome, Minato-ku, 105 6927 Tokyo, JP		
(72)	Motohide Satoh, c/o Central Pharmaceutical Research Institute, 1-1, Murasaki-cho, Takatsuki-shi, Osaka, 569-1125 Osaka, JP Takahisa Motomura, c/o Central Pharmaceutical Research Institute, 1-1, Murasaki-cho, Takatsuki-shi, Osaka, 569-1125 Osaka, JP Takashi Matsuda, c/o Central Pharmaceutical Research Institute, 1-1, Murasaki-cho, Takatsuki-shi, Osaka, 569-1125 Osaka, JP Kentaro Kondo, c/o Central Pharmaceutical Research Institute, 1-1, Murasaki-cho, Takatsuki-shi, Osaka, 569-1125 Osaka, JP Koji Ando, c/o Central Pharmaceutical Research Institute, 1-1, Murasaki-cho, Takatsuki-shi, Osaka, 569-1125 Osaka, JP Koji Matsuda, c/o Central Pharmaceutical Research Institute, 1-1, Murasaki-cho, Takatsuki-shi, Osaka, 569-1125 Osaka, JP Shuji Miyake, c/o Central Pharmaceutical Research Institute, 1-1, Murasaki-cho, Takatsuki-shi, Osaka, 569-1125 Osaka, JP Hideto Uehara, c/o Central Pharmaceutical Research Institute, 1-1, Murasaki-cho, Takatsuki-shi, Osaka, 569-1125 Osaka, JP		
(74)	Hraste & Partneri odvjetničko društvo d.o.o., Zagreb, HR		
<hr/>			
(51)	MKP (10) <b>HR P20231613 T1</b> <b>A61K 31/609</b> (2006.01) <b>A61K 38/26</b> (2006.01) <b>A61K 9/20</b> (2006.01) <b>A61P 3/00</b> (2006.01) <b>A61P 3/04</b> (2006.01) <b>A61P 3/10</b> (2006.01)		
(11)	P20231613 (46) 15.03.2024.		
(21)	P20231613T (22) 11.12.2023.		
(96)	<a href="#">EP 18212576.5</a> 15.03.2013.		
(97)	EP 3542790, 25.09.2019. 201939, En		
(97)	EP 3542790, 13.09.2023. 202337, En		
(31)	12160742 (32) 22.03.2012. (33) EP		

- 201361748844 P 04.01.2013. US  
13153422 31.01.2013. EP  
(62) 13709232.6 ; 15.03.2013.  
(54) **PRIPRAVCI KOJI SADRŽE SREDSTVO ZA UNOŠENJE I NJIHOVA PRIPRAVA**  
COMPOSITIONS COMPRISING A DELIVERY AGENT AND PREPARATION THEREOF  
(73) Novo Nordisk A/S, Novo Allé, 2880 Bagsværd, DK  
(72) Thomas Vilhelmsen, Novo Nordisk A/S, Novo Allé, 2880 Bagsværd, DK  
(74) Vukmir i suradnici odvjetničko društvo d.o.o., Zagreb, HR

- (51) MKP (10) [HR P20231694 T1](#)  
**A61K 31/7034** (2006.01)  
**A61K 31/198** (2006.01)  
**A61K 31/351** (2006.01)  
**A61K 31/401** (2006.01)  
**A61K 38/28** (2006.01)  
**A61K 9/08** (2006.01)  
**A61P 25/00** (2006.01)  
**A61P 29/00** (2006.01)  
**A61P 43/00** (2006.01)  
**A61P 3/00** (2006.01)  
**A61P 3/10** (2006.01)  
**A61P 5/50** (2006.01)  
**A61P 9/10** (2006.01)

- (11) P20231694 (46) 15.03.2024.  
(21) P20231694T (22) 21.12.2023.  
(96) [EP 21155065.2](#) 15.12.2014.  
(97) EP 3862003, 11.08.2021. 202132, En  
(97) EP 3862003, 25.10.2023. 202343, En  
(31) 13197821 (32) 17.12.2013. (33) EP  
14187228 01.10.2014. EP

- (62) 14820808.5 ; 15.12.2014.  
(54) **SGLT-2 INHIBITOR ZA UPORABU U LIJEČENJU METABOLIČKOG POREMEĆAJA KOD ŽIVOTINJA IZ PORODICE MAČAKA**  
AN SGLT-2 INHIBITOR FOR USE IN THE TREATMENT OF A METABOLIC DISORDER IN FELINE ANIMALS  
(73) Boehringer Ingelheim Vetmedica GmbH, Binger Strasse 173, 55216 Ingelheim am Rhein, DE  
(72) Daniela Birte Reiche, Boehringer Ingelheim International GmbH, Corporate Patents, Binger Strasse 173, 55216 Ingelheim am Rhein, DE  
Silke Haag-Diergarten, Boehringer Ingelheim International GmbH, Corporate Patents, Binger Strasse 173, 55216 Ingelheim am Rhein, DE  
Leah Jeanette Hennings, Boehringer Ingelheim Corporation, 900 Ridgebury Road, Ridgefield, CT 06877-0368, US  
Saskia Kley, Boehringer Ingelheim International GmbH, Corporate Patents, Binger Strasse 173, 55216 Ingelheim am Rhein, DE  
Anna Michelle Traas, Boehringer Ingelheim Corporation, 900 Ridgebury Road, Ridgefield, CT 06877-0368, US  
(74) CPZ - CENTAR ZA PATENTE d.o.o., Zagreb, HR

- (51) MKP (10) [HR P20231644 T1](#)  
**A61K 31/721** (2006.01)  
(11) P20231644 (46) 15.03.2024.  
(21) P20231644T (22) 13.12.2023.  
(86) PCT/EP2017051683 26.01.2017.  
(96) [EP 17702813.1](#) 26.01.2017.  
(87) [WO2017129699](#), 03.08.2017.  
(97) EP 3407899, 05.12.2018. 201849, De  
(97) EP 3407899, 11.10.2023. 202341, De  
(31) 102016101448 (32) 27.01.2016. (33) DE  
(54) **IMUNOPROFILAKSA PONAVLJANIH BAKTERIJSKIH INFEKCIJA**  
IMMUNOPROPHYLAXIS FOR RECURRENT BACTERIAL INFECTIONS  
(73) Strathmann GmbH & Co. KG, Langenhorner Chaussee 602, 22419 Hamburg, DE  
(72) Bert Behnke, Sellhopsweg 1, 22459 Hamburg, DE  
Claudia Peschel, Sellhopsweg 1, 22459 Hamburg, DE  
(74) ZMP IP d.o.o., Zagreb, HR

- (51) MKP (10) [HR P20231621 T1](#)  
**A61K 38/13** (2006.01)  
**A61P 37/06** (2006.01)

- A61K 9/00** (2006.01)  
**A61K 47/26** (2006.01)  
**A61K 9/127** (2006.01)  
**A61K 9/19** (2006.01)  
(11) P20231621 (46) 15.03.2024.  
(21) P20231621T (22) 11.12.2023.  
(86) PCT/EP2016055609 15.03.2016.  
(96) [EP 16711565.8](#) 15.03.2016.  
(87) [WO2016146645](#), 22.09.2016.  
(97) EP 3270890, 24.01.2018. 201804, En  
(97) EP 3270890, 13.09.2023. 202337, En  
(31) 15020035 (32) 16.03.2015. (33) EP  
(54) **FORMULACIJE CIKLOSPORINA ZA UPOTREBU U PREVENCIJI ILI LIJEČENJU PLUČNOG KRONIČNOG ODBACIVANJA TRANSPLANTANTA**  
CYCLOSPORINE FORMULATIONS FOR USE IN THE PREVENTION OR TREATMENT OF PULMONARY CHRONIC GRAFT REJECTION  
(73) Breath Therapeutics GmbH, Aldringenstr. 4, 80639 Munchen, DE  
(72) Martin Knoch, Gartenstrasse 11, 82467 Garmisch-Partenkirchen, DE  
Oliver Denk, Nördliche Seestrasse 35, 82541 Münsing, DE  
(74) Tomislav Hadžija, Zagreb, HR

- (51) MKP (10) [HR P20231732 T1](#)  
**A61K 38/21** (2006.01)  
**A61K 47/60** (2017.01)  
**A61P 35/00** (2006.01)  
**A61P 7/00** (2006.01)  
**A61P 19/00** (2006.01)  
**A61P 19/04** (2006.01)  
**A61P 19/08** (2006.01)  
**A61P 31/00** (2006.01)  
**A61P 35/02** (2006.01)  
(11) P20231732 (46) 15.03.2024.  
(21) P20231732T (22) 27.12.2023.  
(86) PCT/US2015059410 06.11.2015.  
(96) [EP 15857703.1](#) 06.11.2015.  
(87) [WO2016073825](#), 12.05.2016.  
(97) EP 3215193, 13.09.2017. 201737, En  
(97) EP 3215193, 04.10.2023. 202340, En  
(31) 14192114 (32) 06.11.2014. (33) EP  
(54) **REŽIM DOZIRANJA PEGILIRANOG INTERFERONA**  
DOSAGE REGIMEN FOR PEGYLATED INTERFERON  
(73) PharmaEssentia Corporation, 13F, No. 3 Park (YuanQu) Street, Nangang District, 11503 Taipei City, TW  
(72) Christoph Klade, Wilhelminenstrasse 91/lif, 1160 Vienna, AT  
Oleh Zagrijtschuk, Wilhelminenstrasse 91/lif, 1160 Vienna, AT  
Ko-Chung Lin, 253 Lincoln Street, Lexington, MA 02421, US  
(74) ZMP IP d.o.o., Zagreb, HR

- (51) MKP (10) [HR P20231569 T1](#)  
**A61K 39/00** (2006.01)  
**A61K 39/395** (2006.01)  
**A61P 35/00** (2006.01)  
**G01N 33/53** (2006.01)  
**C07K 16/24** (2006.01)  
(11) P20231569 (46) 15.03.2024.  
(21) P20231569T (22) 04.12.2023.  
(96) [EP 20155148.8](#) 23.12.2004.  
(97) EP 3718564, 07.10.2020. 202041, En  
(97) EP 3718564, 11.10.2023. 202341, En  
(31) 532130 P (32) 23.12.2003. (33) US  
(62) 04815562.6 ; 23.12.2004.  
(54) **NOVA PROTUTIJELA PROTIV IL 13 I NJIHOVA UPOTREBA**  
NOVEL ANTI-IL 13 ANTIBODIES AND USES THEREOF  
(73) GENENTECH, INC., 1 DNA Way, South San Francisco, CA 94080-4990, US  
(72) Sek Chung Michael Fung, 922 Beacon Square Court, No. 425, Gaithersburg, MD 20878, US  
Matthew Moyle, 5 Betagrass Lane, Newtown, CT 06470, US  
Mason Lu, 5015 Darnell Stree, Houston, TX 77096, US  
Changing Yan, 1800 El Paseo, No.306, Houston, TX 77054, US  
Sanjaya Singh, 4 Owl Ridge Lane, Sandy Hook, CT 06482, US  
Dan Huang, 291 Forest Drive South, Short Hills, NJ 07078, US  
(74) Hraste & Partneri odvjetničko društvo d.o.o., Zagreb, HR

(51)	MKP	(10)	<a href="#">HR P20231570 T1</a>	(74)	CPZ - CENTAR ZA PATENTE d.o.o., Zagreb, HR
	<b>A61K 39/00</b> (2006.01) <b>C07K 16/28</b> (2006.01) <b>A61P 35/00</b> (2006.01) <b>C07K 14/47</b> (2006.01)				
(11)	P20231570	(46)	15.03.2024.		
(21)	P20231570T	(22)	04.12.2023.		
(86)	PCT/EP2017056049		15.03.2017.		
(96)	<a href="#">EP 17710904.8</a>		15.03.2017.		
(87)	<a href="#">WO2017157972</a>		21.09.2017.		
(97)	EP 3430027, 23.01.2019.		201904, En		
(97)	EP 3430027, 13.09.2023.		202337, En		
(31)	201604458 (32)	16.03.2016.	(33) GB		
	201662308944 P	16.03.2016.	US		
(54)	<b>PEPTID ZA UPORABU U IMUNOTERAPIJI PROTIV NESITNOSTANIČNOG RAKA PLUĆA I SITNOSTANIČNOG RAKA PLUĆA</b> PEPTIDE AND COMBINATION OF PEPTIDES FOR USE IN IMMUNOTHERAPY AGAINST NON-SMALL CELL LUNG CANCER AND OTHER CANCERS				
(73)	Immatics Biotechnologies GmbH, Paul-Ehrlich-Strasse 15, 72076 Tübingen, DE				
(72)	Andrea Mahr, Kirschenweg 22, 72076 Tübingen, DE Oliver Schoor, Eichhaldenstrasse 19, 72074 Tübingen, DE Toni Weinschenk, Im Morgenrain 15, 73773 Aichwald, DE				
(74)	ZMP IP d.o.o., Zagreb, HR				
(51)	MKP	(10)	<a href="#">HR P20231581 T1</a>	(73)	Aquanova AG, Birkenweg 8-10, 64295 Darmstadt, DE
	<b>A61K 39/12</b> (2006.01)			(72)	Dariusz Behnam, Schwalbenweg 9, 64380 Rossdorf, DE
(11)	P20231581	(46)	15.03.2024.	(74)	Vukmir i suradnici odvjetničko društvo d.o.o., Zagreb, HR
(21)	P20231581T	(22)	05.12.2023.		
(96)	<a href="#">EP 22182269.5</a>		12.03.2014.		
(97)	EP 4129330, 08.02.2023.		202306, En		
(97)	EP 4129330, 06.09.2023.		202336, En		
(31)	201361800204 P (32)	15.03.2013.	(33) US		
(62)	14722014.9 ; 12.03.2014.				
(54)	<b>PRIPRAVCI I POSTUPCI ZA KIMERNE KONSTRUKTE VIRUSA DENGUA GROZNICE U CJEPIVIMA</b> COMPOSITIONS AND METHODS FOR DENGUE VIRUS CHIMERIC CONSTRUCTS IN VACCINES				
(73)	Takeda Vaccines, Inc., 75 Sidney Street, Cambridge, MA 02139, US The Government of The United States of America as represented by The Secretary of The Department of Health and Human Services, 4770 Buford Highway, Technology Transfer Office (K79), Atlanta, GA 30341, US				
(72)	Dan T. Stinchcomb, Fort Collins, US Claire Kinney, Fort Collins, US Richard M. Kinney, Fort Collins, US Jill A. Livengood, Cambridge, US				
(74)	ZMP IP d.o.o., Zagreb, HR				
(51)	MKP	(10)	<a href="#">HR P20231630 T1</a>	(51)	MKP
	<b>A61K 39/12</b> (2006.01) <b>A61K 39/00</b> (2006.01) <b>A61K 39/23</b> (2006.01) <b>A61K 39/135</b> (2006.01) <b>A61P 31/00</b> (2006.01) <b>A61P 31/20</b> (2006.01)				(10)
(11)	P20231630	(46)	15.03.2024.		<a href="#">HR P20231591 T1</a>
(21)	P20231630T	(22)	12.12.2023.		<b>A61K 47/26</b> (2006.01) <b>A61K 9/107</b> (2006.01) <b>A61K 31/12</b> (2006.01) <b>A61P 3/06</b> (2006.01) <b>A61P 3/04</b> (2006.01) <b>A61P 3/10</b> (2006.01) <b>A61K 31/352</b> (2006.01) <b>A61K 36/185</b> (2006.01) <b>A61K 36/9066</b> (2006.01) <b>A61P 1/16</b> (2006.01) <b>A61K 36/484</b> (2006.01)
(86)	PCT/US2016051736		14.09.2016.	(11)	P20231591 (46)
(96)	<a href="#">EP 16771050.8</a>		14.09.2016.	(21)	P20231591T (22)
(87)	<a href="#">WO2017058521</a>		06.04.2017.	(86)	PCT/EP2018068731 11.07.2018.
(97)	EP 3355915, 08.08.2018.		201832, En	(96)	<a href="#">EP 18738321.1</a> 11.07.2018.
(97)	EP 3355915, 01.11.2023.		202344, En	(87)	<a href="#">WO2019011955</a> , 17.01.2019. , De
(31)	201562234196 P (32)	29.09.2015.	(33) US	(97)	EP 3651805, 20.05.2020. 202021, De
(54)	<b>CJEPIVA SA ČESTICAMA NALIK NA VIRUS (VLP) PSEĆEG PARVOVIRUSA (CPV) I NJIHOVE UPORABE</b> CANINE PARVOVIRUS (CPV) VIRUS-LIKE PARTICLE (VLP) VACCINES AND USES THEREOF			(97)	EP 3651805, 25.10.2023. 202343, De
(73)	Boehringer Ingelheim Animal Health USA Inc., 3239 Satellite Boulevard, Bldg. 500, Duluth, GA 30096, US			(31)	102017115496 (32) 11.07.2017. (33) DE
(72)	Frederic David, 1130 Christian Terrace, Watkinsville, GA 30677, US Zahia Hannas-Djebbara, Les Bastides Du Vallon, 4 Rue Des Chaux, 69340 Francheville, FR Herve Poulet, 2 Place Des Quatre Vierges, 69110 Sainte Foy-Les Lyon, FR Jules Maarten Minke, 12 avenue de la Californie, 06200 Nice, FR				PCT/EP2017/067381 11.07.2017.
					PCT/EP2017/067382 11.07.2017. WO
					WO
				(54)	<b>SOLUBILIZAT S KURKUMINOM I BAREM JEDNOM DRUGOM AKTIVNOM TVARI</b> SOLUBILISATE WITH CURCUMIN AND AT LEAST ONE OTHER ACTIVE SUBSTANCE
				(73)	Aquanova AG, Birkenweg 8-10, 64295 Darmstadt, DE
				(72)	Dariusz Behnam, Schwalbenweg 9, 64380 Rossdorf, DE
				(74)	Vukmir i suradnici odvjetničko društvo d.o.o., Zagreb, HR
				(51)	MKP
					(10)
					<a href="#">HR P20231642 T1</a>
					<b>A61K 47/32</b> (2006.01) <b>A61P 35/00</b> (2006.01) <b>C08F 222/10</b> (2006.01)
				(11)	P20231642 (46)
				(21)	P20231642T (22)
				(86)	PCT/IB2017053567 15.06.2017.
				(96)	<a href="#">EP 17733906.6</a> 15.06.2017.
				(87)	<a href="#">WO2018002761</a> , 04.01.2018. , En
				(97)	EP 3478323, 08.05.2019. 201919, En
				(97)	EP 3478323, 27.09.2023. 202339, En
				(31)	201611405 (32) 30.06.2016. (33) GB
				(54)	<b>KONJUGATI POLIMER-LIJEK KOJI SE MOGU CIJEPATI</b> CLEAVABLE POLYMER DRUG CONJUGATES
				(73)	RS Arastirma Egitim Danismanlik Ilac Sanayi Ticaret Anonim Sirketi, Istanbul Teknopark Kulucka Merkezi Sanayi Mah. Teknopark Blv. No:1/4A 101 Pendik, 34912 Istanbul, TR
				(72)	Rana Sanyal, Bogaziçi Universitesi Kuzey Kampus Kimya Bolumu Bebek, 34342 Istanbul, TR Amitav Sanyal, Bogaziçi Universitesi Kuzey Kampus Kimya Bolumu Bebek, 34342 Istanbul, TR Mehmet Arslan, Bogaziçi Universitesi Kuzey Kampus Kimya Bolumu Bebek, 34342 Istanbul, TR Burcu Sumer Bolu, Bogaziçi Universitesi Kuzey Kampus Kimya Bolumu Bebek, 34342 Istanbul, TR Ozgul Gok, Bogaziçi Universitesi Kuzey Kampus Kimya Bolumu Bebek, 34342 Istanbul, TR Merve Karacivi, Bogaziçi Universitesi Kuzey Kampus Kimya Bolumu Bebek, 34342 Istanbul, TR Sadik Kaga, Bogaziçi Universitesi Kuzey Kampus Kimya Bolumu Bebek, 34342 Istanbul, TR
				(74)	Vukmir i suradnici odvjetničko društvo d.o.o., Zagreb, HR
				(51)	MKP
					(10)
					<a href="#">HR P20231667 T1</a>
					<b>A61K 47/34</b> (2017.01) <b>A61K 9/00</b> (2006.01) <b>A61K 31/445</b> (2006.01)
				(11)	P20231667 (46)
				(21)	P20231667T (22)
				(86)	PCT/EP2020050333 08.01.2020.
				(96)	<a href="#">EP 20700453.2</a> 08.01.2020.
				(97)	<a href="#">WO2020144239</a> , 16.07.2020.
				(97)	EP 3908321, 17.11.2021. 202146, En
				(97)	EP 3908321, 15.11.2023. 202346, En
				(31)	201900258 (32) 08.01.2019. (33) GB
				(54)	<b>FARMACEUTSKI PRIPRAVAK</b> PHARMACEUTICAL COMPOSITION

- (73) MedinCell S.A., 3 rue des frères Lumière, 34830 Jacou, FR  
 (72) Christophe Roberge, c/o MedinCell, 3 rue des Frères Lumière, 34830 Jacou, FR  
 Adolfo Lopez Noriega, c/o MedinCell, 3 rue des Frères Lumière, 34830 Jacou, FR  
 Jean Manuel Cros, c/o MedinCell, 3 rue des Frères Lumière, 34830 Jacou, FR  
 Juliette Serindoux, c/o MedinCell, 3 rue des Frères Lumière, 34830 Jacou, FR  
 Murielle Oster, c/o MedinCell, 3 rue des Frères Lumière, 34830 Jacou, FR  
 Fang Liu, c/o MedinCell, 3 rue des Frères Lumière, 34830 Jacou, FR  
 Charlotte Molinier, c/o MedinCell, 3 rue des Frères Lumière, 34830 Jacou, FR  
 Sylvestre Grizot, c/o MedinCell, 3 rue des Frères Lumière, 34830 Jacou, FR  
 Tjasa Vrlinic, c/o MedinCell, 3 rue des Frères Lumière, 34830 Jacou, FR  
 Feifei Ng, c/o MedinCell, 3 rue des Frères Lumière, 34830 Jacou, FR  
 Elise Guégain, c/o MedinCell, 3 rue des Frères Lumière, 34830 Jacou, FR  
 Marie-Emérentienne Cagnon, c/o MedinCell, 3 rue des Frères Lumière, 34830 Jacou, FR  
 (74) PRODUCTA d.o.o., Zagreb, HR

- (51) MKP (10) [HR P20231629 T1](#)  
**A61K 8/37** (2006.01)  
**A61K 8/49** (2006.01)  
**A61K 8/64** (2006.01)  
**A61P 17/14** (2006.01)  
**A61Q 7/00** (2006.01)  
 (11) P20231629 (46) 15.03.2024.  
 (21) P20231629T (22) 12.12.2023.  
 (86) PCT/US2020044771 03.08.2020.  
 (96) [EP 20760994.2](#) 03.08.2020.  
 (87) [WO2021026084](#), 11.02.2021.  
 (97) EP 3886799, 06.10.2021. 202140, En  
 (97) EP 3886799, 15.11.2023. 202346, En  
 (31) 201962883809 P (32) 07.08.2019. (33) US  
 201962895869 P 04.09.2019. US  
 202063100611 P 23.03.2020. US  
 (54) **PRIPRAVCI ZA LIJEČENJE OPADANJA KOSE**  
 COMPOSITIONS FOR THE TREATMENT OF HAIR LOSS  
 (73) ANEIRA PHARMA, INC., 4660 La Jolla Village Drive, Suite 100 & 200, San Diego, CA 92122, US  
 (72) John Edward Wurst, c/o Aneira Pharma, Inc., 4660 La Jolla Village Drive, Suite 100 & 200, San Diego, CA 92122, US  
 (74) ZMP IP d.o.o., Zagreb, HR

- (51) MKP (10) [HR P20231716 T1](#)  
**A61K 9/00** (2006.01)  
**A61K 47/18** (2017.01)  
**A61K 47/20** (2006.01)  
**A61K 47/22** (2006.01)  
**A61K 31/198** (2006.01)  
**A61K 31/133** (2006.01)  
**A61P 25/16** (2006.01)  
 (11) P20231716 (46) 15.03.2024.  
 (21) P20231716T (22) 22.12.2023.  
 (96) [EP 20198371.5](#) 12.03.2015.  
 (97) EP 3777833, 17.02.2021. 202107, En  
 (97) EP 3777833, 18.10.2023. 202342, En  
 (31) 201461952477 P (32) 13.03.2014. (33) US  
 201461990967 P 09.05.2014. US  
 (62) 15731727.2 ; 12.03.2015.  
 (54) **PRIPRAVCI INHIBITORA DOPA DEKARBOKSILAZE**  
 DOPA DECARBOXYLASE INHIBITOR COMPOSITIONS  
 (73) Neuroderm Ltd., Weizmann Science Park, 3 Golda Meir Street, 7403648 Ness Ziona, IL  
 (72) Oron Yacoby-Zeevi, 204 Hanarkissim Street, 6094600 Bitsaron, IL  
 (74) Vukmir i suradnici odvetničko društvo d.o.o., Zagreb, HR

- (51) MKP (10) [HR P20231729 T1](#)  
**A61K 9/00** (2006.01)  
**A61K 47/02** (2006.01)  
**A61K 47/10** (2017.01)  
**A61K 31/40** (2006.01)

- A61K 31/573** (2006.01)  
**A61P 11/00** (2006.01)  
**A61P 43/00** (2006.01)  
**A61K 31/167** (2006.01)  
 (11) P20231729 (46) 15.03.2024.  
 (21) P20231729T (22) 27.12.2023.  
 (86) PCT/EP2017070850 17.08.2017.  
 (96) [EP 17758473.7](#) 17.08.2017.  
 (87) [WO2018033598](#), 22.02.2018.  
 (97) EP 3500241, 26.06.2019. 201926, En  
 (97) EP 3500241, 04.10.2023. 202340, En  
 (31) 16184608 (32) 17.08.2016. (33) EP  
 (54) **KOMBINIRANA TERAPIJA ZA KOPB**  
 COMBINATION THERAPY FOR COPD  
 (73) Chiesi Farmaceutici S.p.A., Via Palermo, 26/A, 43122 Parma, IT  
 (72) Mario Scuri, Chiesi Farmaceutici S.p.A., Via Palermo 26/A, 43122 Parma, IT  
 Pierfrancesco Coli, Chiesi Farmaceutici S.p.A., Via Palermo 26/A, 43122 Parma, IT  
 Giuseppe Delmonte, Chiesi Farmaceutici S.p.A., Via Palermo 26/A, 43122 Parma, IT  
 (74) Tomislav Hadžija, Zagreb, HR

- (51) MKP (10) [HR P20231653 T1](#)  
**A61K 9/08** (2006.01)  
**A61K 31/4045** (2006.01)  
**A61P 1/00** (2006.01)  
 (11) P20231653 (46) 15.03.2024.  
 (21) P20231653T (22) 14.12.2023.  
 (86) PCT/FI2021050069 02.02.2021.  
 (96) [EP 21706998.8](#) 02.02.2021.  
 (87) [WO2021156540](#), 12.08.2021.  
 (97) EP 4099980, 14.12.2022. 202250, En  
 (97) EP 4099980, 29.11.2023. 202348, En  
 (31) 20205109 (32) 03.02.2020. (33) FI  
 (54) **STABILNI FARMACEUTSKI SASTAVI ROPINIROLA**  
 STABLE PHARMACEUTICAL COMPOSITIONS OF ROPINIROLE  
 (73) Orion Corporation, Orionintie 1, 02200 Espoo, FI  
 (72) Mikko Leskinen, Lahnaruohontie 5 A 9, 00200 Helsinki, FI  
 Jukka Salmia, C/o Orion Corporation, P.O.box 65, 02101 Espoo, FI  
 (74) Tomislav Hadžija, Zagreb, HR

- (51) MKP (10) [HR P20231692 T1](#)  
**A61K 9/10** (2006.01)  
**A61K 47/02** (2006.01)  
**A61K 31/47** (2006.01)  
**A61P 35/00** (2006.01)  
**A61P 43/00** (2006.01)  
 (11) P20231692 (46) 15.03.2024.  
 (21) P20231692T (22) 21.12.2023.  
 (86) PCT/JP2016055268 23.02.2016.  
 (96) [EP 16755489.8](#) 23.02.2016.  
 (87) [WO2016136745](#), 01.09.2016.  
 (97) EP 3263106, 03.01.2018. 201801, En  
 (97) EP 3263106, 25.10.2023. 202343, En  
 (31) 201562120561 P (32) 25.02.2015. (33) US  
 (54) **POSTUPAK ZA SUZBIJANJE GORČINE DERIVATA KINOLINA**  
 METHOD FOR SUPPRESSING BITTERNESS OF QUINOLINE DERIVATIVE  
 (73) Eisai R&D Management Co., Ltd., 4-6-10 Koishikawa Bunkyo-ku, 112-8088 Tokyo, JP  
 (72) Kentaro Nagane, c/o Eisai Co. Ltd., Kawashima Industrial Complex 1 Kawashimatakehaya-machi, 501-6024 Kakamigahara-shi Gifu, JP  
 Yosuke Ueki, c/o Eisai Co. Ltd., Kawashima Industrial Complex 1 Kawashimatakehaya-machi, 501-6024 Kakamigahara-shi Gifu, JP  
 Shusuke Sano, c/o Eisai Co. Ltd., Kawashima Industrial Complex 1 Kawashimatakehaya-machi, 501-6024 Kakamigahara-shi Gifu, JP  
 Takahisa Sakaguchi, c/o Eisai Co. Ltd., Tsukuba Research Laboratories, 5-1-3 Tokodai, 300-2635 Tsukuba-shi Ibaraki, JP  
 (74) PRODUCTA d.o.o., Zagreb, HR

- (51) MKP (10) [HR P20231548 T1](#)  
**A61K 9/16** (2006.01)  
**A61K 9/20** (2006.01)  
**A61K 9/48** (2006.01)  
**A61K 31/506** (2006.01)  
**A61P 35/00** (2006.01)  
 (11) P20231548 (46) 15.03.2024.

(21)	P20231548T	(22)	30.11.2023.	(97)	EP 3938013, 27.09.2023. 202339, En
(86)	PCT/EP2020069165	08.07.2020.		(31)	201962818889 P (32) 15.03.2019. (33) US
(96)	<a href="#">EP 20736349.0</a>	08.07.2020.		(54)	<b>AUTOMATSKI SISTEM ZA UBRIZGAVANJE</b> AUTOMATIC INJECTION SYSTEM
(87)	<a href="#">WO2021005077</a>	14.01.2021.		(73)	Eli Lilly and Company, Lilly Corporate Center, Indianapolis, IN 46285, US
(97)	EP 3996688, 18.05.2022. 202220, En			(72)	William Godwin Atterbury, Eli Lilly and Company, P.O. Bo 6288, Indianapolis, IN 46206-6288, US
(97)	EP 3996688, 06.09.2023. 202336, En				Joseph Daniel Jr. Dennis, Eli Lilly and Company, P.O. Bo 6288, Indianapolis, IN 46205-6288, US
(31)	19185500 (32) 10.07.2019. (33) EP				Brian Charles Kelley, Eli Lilly and Company, P.O. Bo 6288, Indianapolis, IN 46206-6288, US
(54)	<b>FARMACEUTSKI PRIPRAVAK</b> PHARMACEUTICAL PREPARATION				Mark Lafever, Eli Lilly and Company, P.O. Bo 6288, Indianapolis, IN 46206-6288, US
(73)	Merck Patent GmbH, Frankfurter Strasse 250, 64293 Darmstadt, DE				Steven Michael Madland, Eli Lilly and Company, P.O. Bo 6288, Indianapolis, IN 46206-6288, US
(72)	Corinna Schoch, Goethestrasse 9, 68526 Ladenburg, DE Markus Riehl, Topasweg 3, 64287 Darmstadt, DE Gero Hooff, Laerchenweg 8, 68642 Buerstadt, DE Markus Klemm, Am Monfelder See 8, 64807 Dieburg, DE Carsten Schmidt, Annabergrasse 4, 55131 Mainz, DE Markus Weigandt, Trollblumenweg 22, 68259 Mannheim, DE				Andrew Thomas Snow, Eli Lilly and Company, P.O. Bo 6288, Indianapolis, IN 46206-6288, US
(74)	PRODUCTA d.o.o., Zagreb, HR				Jessica Diane Young, Eli Lilly and Company, P.O. Bo 6288, Indianapolis, IN 46206-6288, US
<hr/>					
(51)	MKP (10) <a href="#">HR P20231670 T1</a>			(51)	MKP (10) <a href="#">HR P20231639 T1</a>
	<b>A61K 9/20</b> (2006.01)				<b>A61P 11/00</b> (2006.01)
	<b>A61K 31/5377</b> (2006.01)				<b>C07D 239/69</b> (2006.01)
(11)	P20231670 (46) 15.03.2024.				<b>C07D 515/08</b> (2006.01)
(21)	P20231670T (22) 18.12.2023.			(11)	P20231639 (46) 15.03.2024.
(86)	PCT/IB2019058862 17.10.2019.			(21)	P20231639T (22) 13.12.2023.
(96)	<a href="#">EP 19872427.0</a> 17.10.2019.			(86)	PCT/US2020026331 02.04.2020.
(87)	<a href="#">WO2020079637</a> , 23.04.2020.			(96)	<a href="#">EP 20722087.2</a> 02.04.2020.
(97)	EP 3866767, 25.08.2021. 202134, En			(87)	<a href="#">WO2020206080</a> , 08.10.2020.
(97)	EP 3866767, 29.11.2023. 202348, En			(97)	EP 3946595, 09.02.2022. 202206, En
(31)	20180124171 (32) 18.10.2018. (33) KR			(97)	EP 3946595, 15.11.2023. 202346, En
(54)	<b>FARMACEUTSKI PRIPRAVAK ZA ORALNU PRIMJENU KOJI SADRŽI DERIVAT AMINOPYRIMIDINA ILI NJEGOVI SOL</b> PHARMACEUTICAL COMPOSITION FOR ORAL ADMINISTRATION COMPRISING AMINOPYRIMIDINE DERIVATIVE OR ITS SALT			(31)	201962828699 P (32) 03.04.2019. (33) US
(73)	Yuhan Corporation, 74 Noryangjin-ro Dongjak-gu, 06927 Seoul, KR			(54)	<b>MODULACIJSKA SREDSTVA TRANSMEMBRANSKOG REGULATORA PROVODLJIVOSTI CISTIČNE FIBROZE</b> CYSTIC FIBROSIS TRANSMEMBRANE CONDUCTANCE REGULATOR MODULATING AGENTS
(72)	Seongkyu Kim, 102-207, 293, Sinjeong-ro Yangcheon-gu, 08078 Seoul, KR Deokkyu Lee, 1222-402, 50, Mokdongdong-ro Yangcheon-gu, 08097 Seoul, KR Soo-Won Kim, 902-1103, 167, Hanbora 2-ro Giheung-gu, 17083 Yongin-si Gyeonggi-do, KR Jun-Mo Yang, 1462-1204, 122, Dongtandaerosibeom-gil, 18476 Hwaseong-si Gyeonggi-do, KR Yoong-Sik Park, 201-1801, 49, Daeji-ro, Suji-gu, 16872 Yongin-si Gyeonggi-do Seoul, KR			(73)	Vertex Pharmaceuticals Incorporated, 50 Northern Avenue, Boston, MA 02210, US
(74)	Vukmir i suradnici odvjetničko društvo d.o.o., Zagreb, HR			(72)	Sara, Sabina Hadida Ruah, 50 Northern Avenue, Boston, MA 02210, US Yoshihiro Ishihara, 50 Northern Avenue, Boston, MA 02210, US Paul Krenitsky, 50 Northern Avenue, Boston, MA 02210, US Jason McCartney, 50 Northern Avenue, Boston, MA 02210, US Vito Melillo, 50 Northern Avenue, Boston, MA 02210, US Mark Thomas Miller, 50 Northern Avenue, Boston, MA 02210, US Alina Silina, 50 Northern Avenue, Boston, MA 02210, US Johnny Uy, 50 Northern Avenue, Boston, MA 02210, US Jinglan Zhou, 50 Northern Avenue, Boston, MA 02210, US
<hr/>					
(51)	MKP (10) <a href="#">HR P20231672 T1</a>			(51)	MKP (10) <a href="#">HR P20231608 T1</a>
	<b>A61M 25/10</b> (2013.01)				<b>A61P 1/16</b> (2006.01)
	<b>A61B 17/22</b> (2006.01)				<b>A61P 9/00</b> (2006.01)
(11)	P20231672 (46) 15.03.2024.				<b>A61P 11/00</b> (2006.01)
(21)	P20231672T (22) 19.12.2023.				<b>A61P 13/12</b> (2006.01)
(86)	PCT/JP2019023088 11.06.2019.				<b>A61P 27/00</b> (2006.01)
(96)	<a href="#">EP 19833984.8</a> 11.06.2019.				<b>A61P 35/00</b> (2006.01)
(87)	<a href="#">WO2020012850</a> , 16.01.2020.				<b>C07D 405/14</b> (2006.01)
(97)	EP 3795199, 24.03.2021. 202112, En				<b>C07D 213/71</b> (2006.01)
(97)	EP 3795199, 20.09.2023. 202338, En				<b>C07D 401/12</b> (2006.01)
(31)	2018130087 (32) 09.07.2018. (33) JP				<b>C07D 401/14</b> (2006.01)
(54)	<b>BALONSKI KATETER</b> BALLOON CATHETER				<b>A61K 31/454</b> (2006.01)
(73)	Goodman Co., Ltd., 5th Floor, KDX Nagoya Sakae Building, 4-5-3 Sakae, Naka-ku, Nagoya-shi, 460-0008 Aichi, JP				<b>A61K 31/4545</b> (2006.01)
(72)	Mitsumasa Okamoto, c/o LS Building, 277-1, Idogane-cho, Seto-shi, 489-0976 Aichi, JP Takashi Kunisada, c/o LS Building, 277-1, Idogane-cho, Seto-shi, 489-0976 Aichi, JP				<b>A61K 31/5377</b> (2006.01)
(74)	Hraste & Partneri odvjetničko društvo d.o.o., Zagreb, HR				<b>A61K 45/06</b> (2006.01)
<hr/>					
(51)	MKP (10) <a href="#">HR P20231575 T1</a>			(11)	P20231608 (46) 15.03.2024.
	<b>A61M 5/20</b> (2006.01)			(21)	P20231608T (22) 07.12.2023.
	<b>A61M 5/28</b> (2006.01)			(86)	PCT/EP2019078992 24.10.2019.
(11)	P20231575 (46) 15.03.2024.			(96)	<a href="#">EP 19794970.4</a> 24.10.2019.
(21)	P20231575T (22) 04.12.2023.			(87)	<a href="#">WO2020089026</a> , 07.05.2020. , En
(86)	PCT/US2020021321 06.03.2020.			(97)	EP 3873600, 08.09.2021. 202136, En
(96)	<a href="#">EP 20716631.5</a> 06.03.2020.			(97)	EP 3873600, 20.09.2023. 202338, En
(87)	<a href="#">WO2020190529</a> , 24.09.2020.			(31)	18203196 (32) 29.10.2018. (33) EP
(97)	EP 3938013, 19.01.2022. 202203, En			(54)	<b>DERIVATI PIRIDINIL SULFONAMIDA, NJIHOVI FARMACEUTSKI PRIPRAVCI I NJIHOVE UPORABE</b> PYRIDINYL SULFONAMIDE DERIVATIVES, PHARMACEUTICAL COMPOSITIONS AND USES THEREOF
<hr/>					
(73)	Boehringer Ingelheim International GmbH, Binger Strasse 173, 55216 Ingelheim am Rhein, DE				

- (72) Joerg P. Hehn, Boehringer Ingelheim International GmbH, Corporate Patents, Binger Strasse 173, 55216 Ingelheim am Rhein, DE  
Andreas Blum, Boehringer Ingelheim International GmbH, Corporate Patents, Binger Strasse 173, 55216 Ingelheim am Rhein, DE  
Oliver Hucke, Boehringer Ingelheim International GmbH, Corporate Patents, Binger Strasse 173, 55216 Ingelheim am Rhein, DE  
Stefan Peters, Boehringer Ingelheim International GmbH, Corporate Patents, Binger Strasse 173, 55216 Ingelheim am Rhein, DE
- (74) CPZ - CENTAR ZA PATENTE d.o.o., Zagreb, HR

(51) MKP (10) [HR P20231663 T1](#)  
**A61P 25/28** (2006.01)  
**C07D 498/04** (2006.01)  
**A61K 31/5365** (2006.01)

- (11) P20231663 (46) 15.03.2024.  
(21) P20231663T (22) 18.12.2023.  
(86) PCT/EP2019073303 02.09.2019.  
(96) [EP 19759411.2](#) 02.09.2019.  
(87) [WO2020048904](#), 12.03.2020.  
(97) EP 3846903, 14.07.2021. 202128, En  
(97) EP 3846903, 25.10.2023. 202343, En  
(31) 18192219 (32) 03.09.2018. (33) EP  
(54) **BICIKLIČKI DERIVATI HETEROARILA**  
BICYCLIC HETEROARYL DERIVATIVES  
(73) F. HOFFMANN - LA ROCHE AG, Grenzacherstrasse 124, 4070 Basel, CH  
(72) Hasane Ratni, c/o F. Hoffmann - La Roche AG, Grenzacherstrasse 124, 4070 Basel, CH  
Jennifer Louise Carter, c/o F. Hoffmann - La Roche AG, Grenzacherstrasse 124, 4070 Basel, CH  
(74) CPZ - CENTAR ZA PATENTE d.o.o., Zagreb, HR

(51) MKP (10) [HR P20231661 T1](#)  
**A61P 3/04** (2006.01)  
**A61K 31/472** (2006.01)  
**A61K 31/4725** (2006.01)  
**A61K 31/495** (2006.01)  
**A61K 31/4985** (2006.01)

- (11) P20231661 (46) 15.03.2024.  
(21) P20231661T (22) 15.12.2023.  
(86) PCT/EP2016055735 16.03.2016.  
(96) [EP 16710199.7](#) 16.03.2016.  
(87) [WO2016146712](#), 22.09.2016.  
(97) EP 3271015, 24.01.2018. 201804, En  
(97) EP 3271015, 27.09.2023. 202339, En  
(31) 15159296 (32) 16.03.2015. (33) EP  
15193513 06.11.2015. EP  
(54) **ANTAGONISTI NK-3 RECEPTORA ZA TERAPIJSKO ILI KOZMETIČKO LIJEČENJE VIŠKA TJELESNE MASTI**  
NK-3 RECEPTOR ANTAGONISTS FOR THERAPEUTIC OR COSMETIC TREATMENT OF EXCESS BODY FAT  
(73) OGEDA N.V., Medialaan 50, 1800 Vilvoorde, BE  
(72) Hamid Hoveyda, Rue Meyerbeer, 72, 1190 Bruxelles, BE  
Graeme Fraser, Rue Bois des Conins 19A, 1470 Bousval, BE  
(74) ZMP IP d.o.o., Zagreb, HR

(51) MKP (10) [HR P20231525 T1](#)  
**A61P 35/00** (2006.01)  
**A61P 35/04** (2006.01)  
**A61P 37/04** (2006.01)  
**C12N 15/113** (2010.01)  
**A61K 31/7088** (2006.01)

- (11) P20231525 (46) 15.03.2024.  
(21) P20231525T (22) 27.11.2023.  
(86) PCT/EP2010001062 19.02.2010.  
(96) [EP 10705304.3](#) 19.02.2010.  
(87) [WO2010094499](#), 26.08.2010.  
(97) EP 2398902, 28.12.2011. 201152, En  
(97) EP 2398902, 04.10.2023. 202340, En  
(31) 09002452 (32) 20.02.2009. (33) EP  
154167 P 20.02.2009. US  
09010164 06.08.2009. EP  
231843 P 06.08.2009. US  
09014135 11.11.2009. EP  
260135 P 11.11.2009. US  
(54) **POSTUPCI I PRIPRAVCI ZA DIJAGNOZU I LIJEČENJE RAKA**

- METHODS AND COMPOSITIONS FOR DIAGNOSIS AND TREATMENT OF CANCER  
(73) Astellas Pharma Inc., 5-1, Nihonbashi-Honcho 2-Chome, Chuo-ku, 103-8411 Tokyo, JP  
TRON - Translationale Onkologie an der Universitätsmedizin der Johannes Gutenberg- Universität Mainz gemeinnützige GmbH, Freiligrathstrasse 12, 55131 Mainz, DE  
(72) Ugur Sahin, Philipp-von-Zabern-Platz 1, 55116 Mainz, DE  
Özlem Türeci, Philipp-von-Zabern-Platz 1, 55116 Mainz, DE  
Michael Koslowski, Am Ried 23, 85764 Oberschleissheim, DE  
Gerd Helftenbein, Nieder-Ohmener Str. 16, 35329 Gemünden, DE  
Walter Korden, Hüglerstrasse 3, 65203 Wiesbaden, DE  
Stefan Wöll, Pommardstrasse 22a, 55299 Nackenheim, DE  
Gabriela-Elena Oprea, Am Ostergraben 4, 55128 Mainz, DE  
(74) ZMP IP d.o.o., Zagreb, HR

(51) MKP (10) [HR P20231734 T1](#)  
**A61P 35/00** (2006.01)  
**A61K 31/4747** (2006.01)  
**C07D 487/10** (2006.01)

- (11) P20231734 (46) 15.03.2024.  
(21) P20231734T (22) 27.12.2023.  
(86) PCT/IB2020057285 31.07.2020.  
(96) [EP 20753456.1](#) 31.07.2020.  
(87) [WO2021005586](#), 14.01.2021.  
(97) EP 4013500, 22.06.2022. 202225, En  
(97) EP 4013500, 25.10.2023. 202343, En  
(31) 201962881619 P (32) 01.08.2019. (33) US  
202063009513 P 14.04.2020. US  
202063033932 P 03.06.2020. US  
(54) **TRIKLIČKI AKR1C3 OVISNI KARS INHIBITORI**  
TRICYCLIC AKR1C3 DEPENDENT KARS INHIBITORS  
(73) Novartis AG, Lichtstrasse 35, 4056 Basel, CH  
(72) Chris Adair, c/o Novartis Institutes for BioMedical Research Inc., 250 Massachusetts Avenue, Cambridge, MA 02139, US  
Tracy Chen, c/o Novartis Institutes for BioMedical Research Inc., 250 Massachusetts Avenue, Cambridge, MA 02139, US  
Jian Ding, c/o Novartis Institutes for BioMedical Research Inc., 250 Massachusetts Avenue, Cambridge, MA 02139, US  
Christy Fryer, c/o Novartis Institutes for BioMedical Research Inc., 250 Massachusetts Avenue, Cambridge, MA 02139, US  
Yuko Isome, c/o Novartis Institutes for BioMedical Research Inc., 250 Massachusetts Avenue, Cambridge, MA 02139, US  
Marie-Helene Larraufie, c/o Novartis Institutes for BioMedical Research Inc., 250 Massachusetts Avenue, Cambridge, MA 02139, US  
Katsumasa Nakajima, c/o Novartis Institutes for BioMedical Research Inc., 250 Massachusetts Avenue, Cambridge, MA 02139, US  
Nik Savage, c/o Novartis Institutes for BioMedical Research Inc., 250 Massachusetts Avenue, Cambridge, MA 02139, US  
Ariel Sterling Twomey, c/o Novartis Institutes for BioMedical Research Inc., 250 Massachusetts Avenue, Cambridge, MA 02139, US  
(74) CPZ - CENTAR ZA PATENTE d.o.o., Zagreb, HR

(51) MKP (10) [HR P20231712 T1](#)  
**A63B 71/02** (2006.01)

- (11) P20231712 (46) 15.03.2024.  
(21) P20231712T (22) 22.12.2023.  
(96) [EP 21209715.8](#) 01.04.2017.  
(97) EP 4049730, 31.08.2022. 202235, En  
(97) EP 4049730, 25.10.2023. 202343, En  
(62) 17903682.7; 01.04.2017.  
(54) **SKLOP ZA ŠIPKU ZA PLESNE VJEŽBE**  
ASSEMBLY FOR A DANCE EXERCISE POLE  
(73) X-Pole Asia Limited, Room 611, Building 2, No. 18 Fangsi Road, Songjiang District, 201601 Shanghai, CN  
(72) Clive Maxwell Coote, EN4 0NW London, GB  
Yanwei Yuan, 226199 Nantong City, CN  
(74) Vukmir i suradnici odvjetničko društvo d.o.o., Zagreb, HR

(51) MKP (10) [HR P20231674 T1](#)  
**A63F 1/14** (2006.01)  
**A63F 1/06** (2006.01)

- (11) P20231674 (46) 15.03.2024.  
(21) P20231674T (22) 19.12.2023.  
(86) PCT/IB2021058578 21.09.2021.  
(96) [EP 21790236.0](#) 21.09.2021.



(87)	<a href="#">WO2022238748</a> , 17.11.2022.				
(97)	EP 4139014, 01.03.2023. 202309, En				
(97)	EP 4139014, 11.10.2023. 202341, En				
(54)	<b>CIPELA DJELITELJA KARATA S GURAČEM</b> A CARD DEALING SHOE WITH A PUSHER				
(73)	Stropus Ltd., Riga Feraiou, 7-9, Lizantia Court, Office 310, 1087 Agioi Omologites Nicosia, CY				
(72)	Artjoms Spiridonovs, 1058 Riga, LV				
(74)	Hraste & Partneri odvjetničko društvo d.o.o., Zagreb, HR				
<hr/>					
(51)	MKP	(10)	<a href="#">HR P20231625 T1</a>		
	<b>B02C 18/14</b> (2006.01)				
	<b>B02C 18/18</b> (2006.01)				
	<b>B02C 18/20</b> (2006.01)				
	<b>B23D 61/02</b> (2006.01)				
(11)	P20231625	(46)		15.03.2024.	
(21)	P20231625T	(22)		12.12.2023.	
(96)	<a href="#">EP 19174372.3</a> , 14.05.2019.				
(97)	EP 3738672, 18.11.2020. 202047, En				
(97)	EP 3738672, 22.11.2023. 202347, En				
(54)	<b>UREĐAJ ZA USITNJAVANJE MATERIJALA UKLJUČUJUĆI STACIONARNO KUĆIŠTE I METODU ZA PROIZVODNJU STACIONARNOG KUĆIŠTA</b> AN APPARATUS FOR PULVERIZING MATERIAL INCLUDING A STATIONARY HOUSING AND A METHOD FOR PRODUCING THE STATIONARY HOUSING				
(73)	Klingmill AB, Rådjursvägen 4, 635 11 Eskilstuna, SE				
(72)	Borislav Vujadinovic, Storgatan 57B, 644 31 Eskilstuna, SE				
(74)	Vukmir i suradnici odvjetničko društvo d.o.o., Zagreb, HR				
<hr/>					
(51)	MKP	(10)	<a href="#">HR P20231658 T1</a>		
	<b>B05B 16/20</b> (2018.01)				
	<b>B05B 16/00</b> (2018.01)				
(11)	P20231658	(46)		15.03.2024.	
(21)	P20231658T	(22)		15.12.2023.	
(96)	<a href="#">EP 16206708.6</a> , 23.12.2016.				
(97)	EP 3199246, 02.08.2017. 201731, De				
(97)	EP 3199246, 27.09.2023. 202339, De				
(31)	102016001006	(32)	01.02.2016.	(33)	DE
(54)	<b>POSTROJENJE, MODUL ZA OBRADU I POSTUPAK ZA OBRADU PREDMETA</b> INSTALLATION, TREATMENT MODULE AND METHOD FOR THE TREATMENT OF OBJECTS				
(73)	Eisenmann GmbH, Tübinger Straße 81, 71032 Böblingen, DE				
(72)	Jürgen Heim, Mörikestr. 27, 72406 Bisingen, DE				
(74)	Tomislav Hadžija, Zagreb, HR				
<hr/>					
(51)	MKP	(10)	<a href="#">HR P20231545 T1</a>		
	<b>B23H 9/10</b> (2006.01)				
	<b>B23H 3/04</b> (2006.01)				
	<b>B23H 11/00</b> (2006.01)				
(11)	P20231545	(46)		15.03.2024.	
(21)	P20231545T	(22)		29.11.2023.	
(96)	<a href="#">EP 18168117.2</a> , 19.04.2018.				
(97)	EP 3403755, 21.11.2018. 201847, De				
(97)	EP 3403755, 27.09.2023. 202339, De				
(31)	102017110735	(32)	17.05.2017.	(33)	DE
(54)	<b>POSTUPAK I UREĐAJ ZA PROIZVODNJU METALNE KOMPONENTE, NAROČITO KOMPONENTE LOPATICE TURBOSTROJA</b> METHOD AND APPARATUS FOR PRODUCING A METAL COMPONENT, IN PARTICULAR A BLADE COMPONENT OF A TURBOMACHINE				
(73)	Leistriz Turbinentechnik Nürnberg GmbH, Markgrafenstr. 36-39, 90459 Nürnberg, DE				
(72)	Georg Schmidt, Konrad-Adenauer-Str. 43A, 91126 Schwabach, DE				
(74)	Cindy Liebl, Georg-Löhlein-Str. 3, 90530 Wendelstein, DE				
(74)	PRODUCTA d.o.o., Zagreb, HR				
<hr/>					
(51)	MKP	(10)	<a href="#">HR P20231700 T1</a>		
	<b>B25B 27/02</b> (2006.01)				
	<b>B25B 5/14</b> (2006.01)				
	<b>B25B 27/10</b> (2006.01)				
	<b>B21D 39/04</b> (2006.01)				
	<b>F16L 13/14</b> (2006.01)				
(56)	P20231700	(46)		15.03.2024.	
(21)	P20231700T	(22)		21.12.2023.	
(86)	PCT/KR2019008561, 11.07.2019.				
(96)	<a href="#">EP 19834048.1</a> , 11.07.2019.				
(87)	<a href="#">WO2020013626</a> , 16.01.2020. , Ko				
(97)	EP 3812096, 28.04.2021. 202117, En				
(97)	EP 3812096, 11.10.2023. 202341, En				
(31)	20180081794	(32)	13.07.2018.	(33)	KR
	20190083328		10.07.2019.		KR
(54)	<b>NAPRAVA ZA HVATANJE PREDMETA I ALAT ZA PRIČVRŠČIVANJE CIJEVNOG SPOJA</b> OBJECT GRASPING DEVICE AND SWAGING-TYPE TUBE FITTING FASTENING TOOL USING SAME				
(73)	Megajoint. Co., Ltd., 212B, 50 Yonsei-ro Seodaemun-gu, 0372 Seoul, KR				
(72)	Hyun-Guk Hong, 802-1105, 49, Soman-ro, Deogyang-gu Goyang-si, 10529 Gyeonggi-do, KR				
	Woonghee Cho, 122-204, 143, Haesong-ro, Yeonsu-gu, 22000 Incheon, KR				
	Minsu Jegal, 1013, 10th fl., 157, Songdogukje-daero, Yeonsu-gu, 21984 Incheon, KR				
(74)	PETOŠEVIĆ d.o.o., Zagreb, HR				
<hr/>					
(51)	MKP	(10)	<a href="#">HR P20231680 T1</a>		
	<b>B28C 1/18</b> (2006.01)				
	<b>C04B 33/20</b> (2006.01)				
	<b>C04B 33/30</b> (2006.01)				
	<b>B28B 17/02</b> (2006.01)				
	<b>B28B 3/02</b> (2006.01)				
(11)	P20231680	(46)		15.03.2024.	
(21)	P20231680T	(22)		20.12.2023.	
(86)	PCT/EP2017069715, 03.08.2017.				
(96)	<a href="#">EP 17749433.3</a> , 03.08.2017.				
(87)	<a href="#">WO2018029091</a> , 15.02.2018.				
(97)	EP 3496920, 19.06.2019. 201925, De				
(97)	EP 3496920, 27.09.2023. 202339, De				
(31)	102016114654	(32)	08.08.2016.	(33)	DE
(54)	<b>POSTUPAK I POSTROJENJE ZA PROIZVODNJU CRIJEPA KAO I CRIJEP</b> METHOD AND SYSTEM FOR PRODUCING A ROOF TILE, AND ROOF TILE				
(73)	BMI Deutschland GmbH, Frankfurter Landstr. 2-4, 61440 Oberursel, DE				
(72)	Frank Winter, Am Steinbruch 48, 31162 Bad Salzdetfurth, DE				
(74)	Tomislav Hadžija, Zagreb, HR				
<hr/>					
(51)	MKP	(10)	<a href="#">HR P20231600 T1</a>		
	<b>B32B 7/12</b> (2006.01)				
	<b>B32B 15/082</b> (2006.01)				
	<b>B32B 15/095</b> (2006.01)				
	<b>B32B 15/098</b> (2006.01)				
	<b>B32B 15/10</b> (2006.01)				
	<b>B32B 15/20</b> (2006.01)				
	<b>B32B 21/08</b> (2006.01)				
	<b>B32B 21/10</b> (2006.01)				
	<b>B32B 21/14</b> (2006.01)				
	<b>B32B 3/12</b> (2006.01)				
	<b>B32B 17/06</b> (2006.01)				
	<b>B32B 38/08</b> (2006.01)				
	<b>B32B 37/12</b> (2006.01)				
(11)	P20231600	(46)		15.03.2024.	
(21)	P20231600T	(22)		07.12.2023.	
(86)	PCT/AT2015050124, 18.05.2015.				
(96)	<a href="#">EP 15729745.8</a> , 18.05.2015.				
(87)	<a href="#">WO2015176093</a> , 26.11.2015.				
(97)	EP 3174707, 07.06.2017. 201723, De				
(97)	EP 3174707, 11.10.2023. 202341, De				
(31)	503642014	(32)	21.05.2014.	(33)	AT
(54)	<b>KOMPOZITNI ELEMENT KOJI SADRŽI POKROVNI SLOJ FURNIRA</b> COMPOSITE ELEMENT WITH A COVERING LAYER OF VENEER				
(73)	F. List GmbH, List-Straße 1, 2842 Thomasberg, AT				
(72)	René Buchinger, Jutesiedlung 6, 2491 Neufeld an der Leitha, AT				
(74)	ZMP IP d.o.o., Zagreb, HR				
<hr/>					
(51)	MKP	(10)	<a href="#">HR P20231660 T1</a>		
	<b>B41J 2/045</b> (2006.01)				
(11)	P20231660	(46)		15.03.2024.	

(21) P20231660T	(22)	15.12.2023.	(97) EP 4028319, 13.09.2023. 202337, En
(96) <a href="#">EP 21176364.4</a>	06.02.2019.		(54) <b>OKOMITA KOMPONENTA SNASTI, OSOBITO JARBOL PLOVILA, I POSTUPAK NJEGOVE PROIZVODNJE</b>
(97) EP 3892471, 13.10.2021. 202141, En			STANDING RIGGING COMPONENT, IN PARTICULAR THE MAST OF A VESSEL, AND THE METHOD OF ITS MANUFACTURE
(97) EP 3892471, 29.11.2023. 202348, En			(73) Sunreef Venture S.A., Ul. Tarcice 6, 80-718 Gdansk, PL
(62) 19706140.1 ; 06.02.2019.			(72) Loïc Vénéce, 13 rue Joseph le Brix, 33000 Bordeaux, FR
(54) <b>KOMPONENTA ZA ISPIS S NIZOM MEMORIJE S POMOĆU ISPREKIDANOG SIGNALA SATA</b>			(74) Hraste & Partneri odvjetničko društvo d.o.o., Zagreb, HR
PRINT COMPONENT WITH MEMORY ARRAY USING INTERMITTENT CLOCK SIGNAL			
(73) Hewlett-Packard Development Company, L.P., 10300 Energy Drive, Spring, TX 77389, US			
(72) Scott A. Linn, Oregon, US			
Michael W. Cumbie, Oregon, US			
James Michael Gardner, Oregon, US			
(74) Vukmir i suradnici odvjetničko društvo d.o.o., Zagreb, HR			
<hr/>			
(51) MKP	(10)	<a href="#">HR P20231738 T1</a>	
<b>B44B 5/00</b> (2006.01)			
<b>B44B 5/02</b> (2006.01)			
(11) P20231738	(46)	15.03.2024.	
(21) P20231738T	(22)	28.12.2023.	
(96) <a href="#">EP 20196045.7</a>	14.09.2020.		
(97) EP 3967512, 16.03.2022. 202211, De			
(97) EP 3967512, 06.12.2023. 202349, De			
(54) <b>UREĐAJ ZA UTISKIVANJE FILMA</b>			
DEVICE FOR EMBOSING FILMS			
(73) Gerhard Rauch Ges.m.b.H., Gewerbepark 1, 3452 Trasdorf, AT			
(72) Anton Buresch, 3452 Trasdorf, AT			
(74) ZMP IP d.o.o., Zagreb, HR			
<hr/>			
(51) MKP	(10)	<a href="#">HR P20231688 T1</a>	
<b>B44C 5/04</b> (2006.01)			
(11) P20231688	(46)	15.03.2024.	
(21) P20231688T	(22)	20.12.2023.	
(96) <a href="#">EP 18178396.0</a>	02.08.2012.		
(97) EP 3401116, 14.11.2018. 201846, De			
(97) EP 3401116, 04.10.2023. 202340, De			
(31) PCT/EP2012/055967	(32) 02.04.2012.	(33) WO	
(62) 12741023.1 ; 02.08.2012.			
(54) <b>PVC PLASTIČNA PLOČA</b>			
PVC PLASTIC PANEL			
(73) Lignum Technologies AG, Rütihofstrasse 1, 9052 Niederteufen, CH			
(72) Dieter Döhning, Am Ring 49, 01561 Großenhain, DE			
(74) ZMP IP d.o.o., Zagreb, HR			
<hr/>			
(51) MKP	(10)	<a href="#">HR P20231723 T1</a>	
<b>B60H 1/00</b> (2006.01)			
<b>B60H 1/14</b> (2006.01)			
<b>B60H 1/22</b> (2006.01)			
(11) P20231723	(46)	15.03.2024.	
(21) P20231723T	(22)	27.12.2023.	
(86) PCT/EP2021073471	25.08.2021.		
(96) <a href="#">EP 21766635.3</a>	25.08.2021.		
(87) <a href="#">WO2022078661</a> ,	21.04.2022.		
(97) EP 4107017, 28.12.2022. 202252, En			
(97) EP 4107017, 06.12.2023. 202349, En			
(31) 20202113	(32) 15.10.2020.	(33) EP	
(54) <b>SUSTAV REGULACIJE TOPLINE I ELEKTRIČNO VOZILO KOJE UKLJUČUJE SUSTAV REGULACIJE TOPLINE</b>			
THERMAL MANAGEMENT SYSTEM AND AN ELECTRIC VEHICLE INCLUDING THE THERMAL MANAGEMENT SYSTEM			
(73) Ymer Technology AB, Östhammarsgatan 68, 6 tr, 115 28 Stockholm, SE			
(72) Josef Graubmann, 86926 Greifenberg am Ammersee, DE			
(74) Vukmir i suradnici odvjetničko društvo d.o.o., Zagreb, HR			
<hr/>			
(51) MKP	(10)	<a href="#">HR P20231603 T1</a>	
<b>B63B 15/00</b> (2006.01)			
(11) P20231603	(46)	15.03.2024.	
(21) P20231603T	(22)	07.12.2023.	
(86) PCT/PL2019000078	11.09.2019.		
(96) <a href="#">EP 19798760.5</a>	11.09.2019.		
(87) <a href="#">WO2021049958</a> ,	18.03.2021.		
(97) EP 4028319, 20.07.2022. 202229, En			
<hr/>			
(51) MKP	(10)	<a href="#">HR P20231589 T1</a>	
<b>B64D 11/02</b> (2006.01)			
<b>E06B 3/36</b> (2006.01)			
<b>E04H 1/12</b> (2006.01)			
(11) P20231589	(46)	15.03.2024.	
(21) P20231589T	(22)	05.12.2023.	
(86) PCT/AT2020060431	04.12.2020.		
(96) <a href="#">EP 20824430.1</a>	04.12.2020.		
(87) <a href="#">WO2021108825</a> ,	10.06.2021. , De		
(97) EP 4069587, 12.10.2022. 202241, De			
(97) EP 4069587, 27.09.2023. 202339, De			
(31) 5021319 U	(32) 04.12.2019.	(33) AT	
(54) <b>PALUBNA TOALETNA KABINA</b>			
ON-BOARD TOILET CABIN			
(73) FACC AG, Fischerstrasse 9, 4910 Ried im Innkreis, AT			
(72) Jesus Rodríguez-Conde, Zeileisstrasse 6, 4600 Wels, AT			
Bernhard Hatzmann, Brunham 38, 4716 Hofkirchen, AT			
Maximilian Gürocak, Steiningergergasse 3, 94032 Passau, DE			
(74) CPZ - CENTAR ZA PATENTE d.o.o., Zagreb, HR			
<hr/>			
(51) MKP	(10)	<a href="#">HR P20231651 T1</a>	
<b>B65B 7/28</b> (2006.01)			
<b>B65B 7/16</b> (2006.01)			
<b>B65B 47/00</b> (2006.01)			
<b>B65B 51/02</b> (2006.01)			
<b>B65B 55/24</b> (2006.01)			
<b>B65B 57/06</b> (2006.01)			
<b>B65B 61/00</b> (2006.01)			
<b>B65D 77/20</b> (2006.01)			
(11) P20231651	(46)	15.03.2024.	
(21) P20231651T	(22)	14.12.2023.	
(86) PCT/IB2020053663	17.04.2020.		
(96) <a href="#">EP 20725928.4</a>	17.04.2020.		
(87) <a href="#">WO2020212933</a> ,	22.10.2020. , En		
(97) EP 3956241, 23.02.2022. 202208, En			
(97) EP 3956241, 04.10.2023. 202340, En			
(31) 201900006142	(32) 19.04.2019.	(33) IT	
(54) <b>POSTUPAK PROIZVODNJE SPREMNIKA ZA PREHRAMBENE PROIZVODE</b>			
METHOD TO MANUFACTURE A CONTAINER FOR FOOD PRODUCTS			
(73) Siropack Italia S.r.l., Via Bailitrona, 22C, 47042 Cesenatico (FC), IT			
(72) Rocco De Lucia, Via Cesenatico, 5815, 47521 Cesena (FC), IT			
(74) PETOŠEVIĆ d.o.o., Zagreb, HR			
<hr/>			
(51) MKP	(10)	<a href="#">HR P20231725 T1</a>	
<b>B65D 1/18</b> (2006.01)			
<b>B65D 1/48</b> (2006.01)			
<b>B65D 25/34</b> (2006.01)			
<b>B65D 43/02</b> (2006.01)			
<b>B65D 43/16</b> (2006.01)			
<b>B65D 75/22</b> (2006.01)			
(11) P20231725	(46)	15.03.2024.	
(21) P20231725T	(22)	27.12.2023.	
(96) <a href="#">EP 22155043.7</a>	03.02.2022.		
(97) EP 4043356, 17.08.2022. 202233, Fr			
(97) EP 4043356, 29.11.2023. 202348, Fr			
(31) 2101346	(32) 12.02.2021.	(33) FR	
(54) <b>DVOMATERIJALNO PAKIRANJE IZRAĐENOG OD PLASTIKE I KARTONA ILI DRUGOG BIOLOŠKOG MATERIJALA SA POKRIVAČEM</b>			
BI-MATERIAL PACKAGING MADE FROM PLASTIC AND CARDBOARD OR ANOTHER BIO-SOURCED MATERIAL WITH COVER.			
(73) Groupe Guillin, Zone Industrielle, Ave. du Maréchal de Lattre de Tassigny, 25290 Ornans, FR			
(72) Frédéric Michon, 70700 Gezier et Fontenelay, FR			

(74) Vukmir i suradnici odvjetničko društvo d.o.o., Zagreb, HR

**HR P20231635 T1**

(51) MKP (10)  
**B65D 21/02** (2006.01)  
**B65D 81/26** (2006.01)  
**B65D 1/22** (2006.01)  
**A47L 19/04** (2006.01)

(11) P20231635 (46) 15.03.2024.  
(21) P20231635T (22) 12.12.2023.

(96) [EP 19190409.3](#) 07.08.2019.  
(97) EP 3626646, 25.03.2020. 202013, De  
(97) EP 3626646, 11.10.2023. 202341, De

(31) 2922018 (32) 19.09.2018. (33) AT

(54) **KUTIJA KOJU SE MOŽE NASLAGIVATI**  
STACKABLE TRAY

(73) FRIES PLANUNGS- UND MARKETINGGESELLSCHAFT m.b.H.,  
Schützenstrasse 19, 6832 Sulz, AT

(72) Markus Grabher, Holzmühlestrasse 4, 6890 Lustenau, AT

(74) Hraste & Partneri odvjetničko društvo d.o.o., Zagreb, HR

**HR P20231573 T1**

(51) MKP (10)  
**B65D 5/20** (2006.01)  
**B65D 5/24** (2006.01)  
**B65D 5/68** (2006.01)

(11) P20231573 (46) 15.03.2024.  
(21) P20231573T (22) 04.12.2023.

(96) [EP 22165890.9](#) 31.03.2022.  
(97) EP 4071067, 12.10.2022. 202241, De  
(97) EP 4071067, 13.09.2023. 202337, De

(31) 752021 (32) 08.04.2021. (33) AT

(54) **AMBALAŽA**  
PACKAGING

(73)(72) Heiner Messerle, Rebgarten 3, 6973 Höchst, AT

(74) Hraste & Partneri odvjetničko društvo d.o.o., Zagreb, HR

**HR P20231551 T1**

(51) MKP (10)  
**B65D 85/804** (2006.01)  
**A47J 31/02** (2006.01)

(11) P20231551 (46) 15.03.2024.  
(21) P20231551T (22) 30.11.2023.

(86) PCT/IB2020054013 29.04.2020.  
(96) [EP 20742840.0](#) 29.04.2020.  
(87) [WO2021165727](#), 26.08.2021.  
(97) EP 4107091, 28.12.2022. 202252, En  
(97) EP 4107091, 18.10.2023. 202342, En

(31) 202005104 (32) 18.02.2020. (33) BE

(54) **FILTER ZA PRIPREMU KAVE ILI INFUZIJE**  
FILTER FOR PREPARING COFFEE OR INFUSION

(73) Koffie F. Rombouts, Naamloze Vennootschap, Antwerpsesteenweg  
136, 2630 Aartselaar, BE

(72) Xavier Rombouts, Bonaventurestraat 114 bus 10, 1090 Jette, BE

(74) ZMP IP d.o.o., Zagreb, HR

**HR P20231554 T1**

(51) MKP (10)  
**C04B 28/00** (2006.01)  
**C04B 28/02** (2006.01)  
**C04B 28/08** (2006.01)  
**C04B 28/12** (2006.01)  
**C04B 28/14** (2006.01)  
**C04B 28/26** (2006.01)  
**B28B 1/00** (2006.01)  
**B28B 13/02** (2006.01)

(11) P20231554 (46) 15.03.2024.  
(21) P20231554T (22) 30.11.2023.

(86) PCT/EP2020073347 20.08.2020.  
(96) [EP 20760813.4](#) 20.08.2020.  
(87) [WO2021047875](#), 18.03.2021.  
(97) EP 4028371, 20.07.2022. 202229, De  
(97) EP 4028371, 27.09.2023. 202339, De

(31) 102019124726 (32) 13.09.2019. (33) DE

(54) **BETONSKI ELEMENT I POSTUPAK NJEGOVE PROIZVODNJE**  
CONCRETE ELEMENT AND METHOD FOR THE PRODUCTION  
THEREOF

(73) METTEN Technologies GmbH & Co. KG, Hammermühle 24, 51491  
Overath, DE

(72) Guido Volmer, An der Vogelstange 9, 59597 Erwitte, DE  
Michael Metten, Romaneyer Höhe 12, 51467 Bergisch Gladbach,  
DE

(74) Hraste &amp; Partneri odvjetničko društvo d.o.o., Zagreb, HR

**HR P20231742 T1**

(51) MKP (10)  
**C07C 333/04** (2006.01)

(11) P20231742 (46) 15.03.2024.  
(21) P20231742T (22) 28.12.2023.

(86) PCT/US2017067756 20.12.2017.  
(96) [EP 17826404.0](#) 20.12.2017.  
(87) [WO2018119163](#), 28.06.2018.  
(97) EP 3558943, 30.10.2019. 201944, En  
(97) EP 3558943, 18.10.2023. 202342, En

(31) 201615387067 (32) 21.12.2016. (33) US  
PCT/US2017/015886 20.12.2017. WO

(54) **KATIONSKI LIPID KOJI SE MOŽE IONIZIRATI ZA ISPORUKU**  
**RNA**  
IONIZABLE CATIONIC LIPID FOR RNA DELIVERY

(73) Arcturus Therapeutics, Inc., 10628 Science Center Drive, Suite 250,  
San Diego, CA 92121, US

(72) Joseph E. Payne, c/o Arcturus Therapeutics, Inc., 10628 Science  
Center Drive, Suite 250, San Diego, CA 92121, US  
Padmanabh Chivikula, c/o Arcturus Therapeutics, Inc., 10628  
Science Center Drive, Suite 250, San Diego, CA 92121, US  
Steven P. Tanis, c/o Arcturus Therapeutics, Inc., 10628 Science  
Center Drive, Suite 250, San Diego, CA 92121, US  
Priya Karmali, c/o Arcturus Therapeutics, Inc., 10628 Science  
Center Drive, Suite 250, San Diego, CA 92121, US

(74) CPZ - CENTAR ZA PATENTE d.o.o., Zagreb, HR

**HR P20231676 T1**

(51) MKP (10)  
**C07C 403/24** (2006.01)  
**A61K 31/22** (2006.01)  
**A61P 9/00** (2006.01)

(11) P20231676 (46) 15.03.2024.  
(21) P20231676T (22) 19.12.2023.

(96) [EP 21382644.9](#) 16.07.2021.  
(97) EP 4119538, 18.01.2023. 202303, En  
(97) EP 4119538, 29.11.2023. 202348, En

(54) **ESTERI AMARUCIAKSANTINA A I NJIHOVA UPOTREBA**  
AMAROUICAXANTHIN A ESTERS AND USES THEREOF

(73) Gat Therapeutics S.L., Baldiri Reixac 4-10, 08028 Barcelona, ES

(72) Noemí García-Delgado Banchs, E-08950 Esplugues del Llobregat  
(Barcelona), ES  
Eugènia Ruiz Cánovas, E-08401 Granollers (Barcelona), ES  
Jaume Mercadé Roca, E-08028 Barcelona, ES

(74) Hraste & Partneri odvjetničko društvo d.o.o., Zagreb, HR

**HR P20231616 T1**

(51) MKP (10)  
**C07D 223/16** (2006.01)  
**C07D 401/14** (2006.01)  
**C07D 401/06** (2006.01)  
**C07D 401/10** (2006.01)  
**C07D 403/06** (2006.01)  
**C07D 405/12** (2006.01)  
**C07D 409/12** (2006.01)  
**A61P 13/12** (2006.01)  
**A61K 31/55** (2006.01)

(11) P20231616 (46) 15.03.2024.  
(21) P20231616T (22) 11.12.2023.

(96) [EP 22164702.7](#) 29.06.2018.  
(97) EP 4056557, 14.09.2022. 202237, En  
(97) EP 4056557, 22.11.2023. 202347, En

(31) PCT/JP2017/024211 (32) 30.06.2017. (33) WO  
18743103.6 ; 29.06.2018.

(54) **DERIVATI BENZAZEPINA**  
BENZAZEPINE DERIVATIVES

(73) Otsuka Pharmaceutical Co., Ltd., 2-9, Kanda Tsukasa-machi,  
Chiyoda-ku, 101-8535 Tokyo, JP

(72) Keizo Kan, 540-0021 Osaka-shi, Osaka, JP  
Masatoshi Takuwa, 540-0021 Osaka-shi, Osaka, JP  
Hirota Tanaka, 540-0021 Osaka-shi, Osaka, JP  
Hideto Fujiwara, 540-0021 Osaka-shi, Osaka, JP  
Hokuto Yamabe, 540-0021 Osaka-shi, Osaka, JP  
Satoshi Matsuda, 540-0021 Osaka-shi, Osaka, JP  
Kazuhiro Ohdachi, 540-0021 Osaka-shi, Osaka, JP  
Taiki Hanari, 540-0021 Osaka-shi, Osaka, JP

Yasuhiro Menjo, 540-0021 Osaka-shi, Osaka, JP  
Tatsuya Urushima, 540-0021 Osaka-shi, Osaka, JP  
Shigekazu Fujita, 540-0021 Osaka-shi, Osaka, JP  
(74) ZMP IP d.o.o., Zagreb, HR

(51) MKP (10) [HR P20231571 T1](#)  
**C07D 239/16** (2006.01)  
**C07D 239/12** (2006.01)  
**C07D 401/12** (2006.01)  
**C07D 403/12** (2006.01)  
**C07D 405/12** (2006.01)  
**C07D 413/12** (2006.01)  
**A61K 31/505** (2006.01)  
**A61P 31/14** (2006.01)

(11) P20231571 (46) 15.03.2024.  
(21) P20231571T (22) 04.12.2023.

(86) PCT/EP2019068461 09.07.2019.

(96) [EP 19742312.2](#) 09.07.2019.

(87) [WO2020011812](#), 16.01.2020.

(97) EP 3820849, 19.05.2021. 202120, En

(97) EP 3820849, 06.09.2023. 202336, En

(31) 18305911 (32) 09.07.2018. (33) EP

(54) **DERIVATI FENIL/PIRIDIL-NH-FENIL/PIRIDIL ZA LIJEČENJE INFEKCIJA RNA VIRUSOM**  
PHENYL/PYRIDYL-N-PHENYL/PYRIDYL DERIVATIVES FOR TREATING RNA VIRUS INFECTION

(73) ABIVAX, 7-11 Boulevard Haussmann, 75009 Paris, FR  
CNRS Centre National de la Recherche Scientifique, 3 rue Michel Ange, 75794 Paris Cedex 16, FR  
Universite de Montpellier, 163 rue Auguste Broussonnet, 34090 Montpellier, FR  
Institut Curie, 26, rue d'Ulm, 75248 Paris Cedex 05, FR

(72) Didier Scherrer, 18 avenue de la Fée Mélusine, 34170 Castelnaud-le-Lez, FR

Jamal Tazi, 4 rue Condorcet, 34380 Clapiers, FR  
Florence Mahuteau-Betzer, 36 avenue Hoche, 78470 Saint Remy-les-Chevreuse, FR  
Romain Najman, 29b rue du 11 Novembre 1918, 94240 L'Hay-les-Roses, FR  
Julien Santo, 190 rue des Carignans, 34790 Grabels, FR  
Cécile Apolit, 3 rue des Terrasses, 34790 Grabels, FR

(74) PRODUCTA d.o.o., Zagreb, HR

(51) MKP (10) [HR P20231538 T1](#)  
**C07D 243/24** (2006.01)  
**A61K 31/5513** (2006.01)  
**A61P 25/02** (2006.01)

(11) P20231538 (46) 15.03.2024.  
(21) P20231538T (22) 29.11.2023.

(86) PCT/UA2019000020 30.01.2019.

(96) [EP 19901248.5](#) 30.01.2019.

(87) [WO2020131000](#), 25.06.2020.

(97) EP 3898596, 27.10.2021. 202143, En

(97) EP 3898596, 06.09.2023. 202336, En

(31) 201812659 (32) 20.12.2018. (33) UA

(54) **FARMACEUTSKI SPOJ, POSTUPAK ZA NJEGOVU IZRADU I UPORABA KAO LIJEKOVITOG SREDSTVA**  
PHARMACEUTICAL COMPOUND, THE METHOD OF ITS MAKING AND USE AS MEDICINAL AGENT

(73/72) Anatolij Reder, Yasnaya street, 13/34, 65012 Odessa, Odessa region, UA  
Dmytro Pozigun, Deribasovskaya street, 4/9, 65026 Odessa, Odessa region, UA

(74) ZMP IP d.o.o., Zagreb, HR

(51) MKP (10) [HR P20231697 T1](#)  
**C07D 295/205** (2006.01)  
**C07C 57/15** (2006.01)  
**A61P 29/00** (2006.01)  
**A61P 25/00** (2006.01)  
**A61K 31/496** (2006.01)

(11) P20231697 (46) 15.03.2024.  
(21) P20231697T (22) 21.12.2023.

(96) [EP 21199077.5](#) 15.11.2017.

(97) EP 3964503, 09.03.2022. 202210, En

(97) EP 3964503, 08.11.2023. 202345, En

(31) 201662423126 P (32) 16.11.2016. (33) US

(62) 17872429.0 ; 15.11.2017.

(54) **KRISTALNI OBLIK MAGL INHIBITORA**  
A CRYSTALLINE FORM OF A MAGL INHIBITOR

(73) H. Lundbeck A/S, Ottiliavej 9, 2500 Valby, DK

(72) Cheryl A. Grice, San Diego, US

Todd K. Jones, San Diego, US

Kurt G. Grimm, San Diego, US

Jacqueline Lorayne Blankman, San Diego, US

Channing Rodney Beals, San Diego, US

(74) ZMP IP d.o.o., Zagreb, HR

(51) MKP (10) [HR P20231690 T1](#)  
**C07D 307/87** (2006.01)  
**C07D 231/12** (2006.01)  
**C07D 241/12** (2006.01)  
**C07D 249/08** (2006.01)  
**C07D 233/56** (2006.01)  
**C07D 237/08** (2006.01)  
**C07D 239/26** (2006.01)  
**A61K 31/343** (2006.01)  
**A61K 31/415** (2006.01)  
**A61K 31/4164** (2006.01)  
**A61K 31/4965** (2006.01)  
**A61P 29/00** (2006.01)  
**A61P 37/00** (2006.01)

(11) P20231690 (46) 15.03.2024.  
(21) P20231690T (22) 21.12.2023.

(86) PCT/EP2018070799 31.07.2018.

(96) [EP 18755728.5](#) 31.07.2018.

(87) [WO2019025467](#), 07.02.2019.

(97) EP 3661921, 10.06.2020. 202024, En

(97) EP 3661921, 18.10.2023. 202342, En

(31) 201712282 (32) 31.07.2017. (33) GB

(54) **SELEKTIVNI INHIBITORI NLRP3 INFLAMASOMA**  
SELECTIVE INHIBITORS OF NLRP3 INFLAMMASOME

(73) Nodthera Limited, The Mansion, Chesterford Research Park, Little Chesterford, Saffron Walden, CB10 1XL Essex, GB  
(72) Mark G. Bock, 285 Columbus Ave. 704, Boston, MA 02116-5296, US  
Alan Paul Watt, Suite 8 The Mansion, Chesterford Research Park, Little Chesterford, Saffron Walden, CB10 1XL Essex, GB  
Roderick Alan Porter, 89 Back Street, SG7 5PG Ashwell, Baldock Hertfordshire, GB  
David Harrison, Suite 8 The Mansion, Chesterford Research Park, Little Chesterford, Saffron Walden, CB10 1XL Essex, GB  
Nicolas Felix Pierre Boutard, c/o Selvita S.A., Park Life Science, ul.Bobryzynskiego 14, 30-348 Krakow, PL  
Grzegorz Witold Topolnicki, Bytomska 51/4, 41-940 Piekary Slaskie, PL  
Charles-Henry Robert Yves Fabritius, Admiralska 34, 60-480 Poznan, PL  
Oleksandr Levenets, c/o Selvita S.A., Park Life Science, ul.Bobryzynskiego 14, 30-348 Krakow, PL

(74) PRODUCTA d.o.o., Zagreb, HR

(51) MKP (10) [HR P20231618 T1](#)  
**C07D 401/12** (2006.01)  
**C07D 401/14** (2006.01)

(11) P20231618 (46) 15.03.2024.  
(21) P20231618T (22) 11.12.2023.

(86) PCT/US2020045368 07.08.2020.

(96) [EP 20758409.5](#) 07.08.2020.

(87) [WO2021026436](#), 11.02.2021.

(97) EP 4010331, 15.06.2022. 202224, En

(97) EP 4010331, 04.10.2023. 202340, En

(31) 201962884480 P (32) 08.08.2019. (33) US

(54) **POSTUPAK ZA PRIPREMU IVOSIDENIBA I NJEGOVOG INTERMEJARA**  
A METHOD FOR PREPARING IVOSIDENIB AND AN INTERMEDIATE THEREOF

(73) Les Laboratoires Servier, 50 rue Carnot, 92284 Suresnes cedex, FR

(72) Jacob Paul Sizemore, 88 Sidney Street, Cambridge, MA 02139, US

Shijie Zhang, 88 Sidney Street, Cambridge, MA 02139, US

Nha Huu Vo, 88 Sidney Street, Cambridge, MA 02139, US

(74) ZMP IP d.o.o., Zagreb, HR

(51) MKP (10) [HR P20231547 T1](#)  
**C07D 403/12** (2006.01)  
**C07D 401/14** (2006.01)

	<b>C07D 405/14</b> (2006.01)				Hanqing Dong, 248 Opening Hill Road, Madison, CT 06443, US
	<b>C07D 413/14</b> (2006.01)				Jing Wang, 25 Elm Street, Milford, CT 06460, US
	<b>A61K 31/4418</b> (2006.01)				Keith R. Hornberger, 182 Wolf Pit Drive, Southburg, CT 06488, US
	<b>A61K 31/505</b> (2006.01)				(74) PRODUCTA d.o.o., Zagreb, HR
	<b>A61K 31/506</b> (2006.01)				
	<b>A61K 31/513</b> (2006.01)				
	<b>A61K 31/5377</b> (2006.01)				
	<b>A61K 31/55</b> (2006.01)				
	<b>C07D 401/04</b> (2006.01)				
	<b>C07D 403/14</b> (2006.01)				
	<b>C07D 413/12</b> (2006.01)				
	<b>C07D 495/04</b> (2006.01)				
	<b>A61P 25/28</b> (2006.01)				
(11)	P20231547	(46)		15.03.2024.	
(21)	P20231547T	(22)		30.11.2023.	
(86)	PCT/US2016062154		16.11.2016.		
(96)	<a href="#">EP 16805251.2</a>		16.11.2016.		
(87)	<a href="#">WO2017087445</a>		26.05.2017.		
(97)	EP 3377484, 26.09.2018.		201839, En		
(97)	EP 3377484, 06.09.2023.		202336, En		
(31)	201562256199 P	(32)	17.11.2015.	(33)	US
(54)	<b>POSTUPCI LIJEČENJA MULTIPLE SKLEROZE PRIMJENOM SPOJEVA PIRIMIDINA I PIRIDINA S AKTIVNOŠĆU INHIBICIJE BTK</b>				
	METHODS FOR TREATING MULTIPLE SCLEROSIS USING PYRIMIDINE AND PYRIDINE COMPOUNDS WITH BTK INHIBITORY ACTIVITY				
(73)	Merck Patent GmbH, Frankfurter Strasse 250, 64293 Darmstadt, DE				
(72)	Tammy Dellovade, 132 Hartwell Road, Carlisle, MA 01741, US				
(74)	PRODUCTA d.o.o., Zagreb, HR				
(51)	MKP	(10)			<b><a href="#">HR P20231748 T1</a></b>
	<b>C07D 413/14</b> (2006.01)				
	<b>A61K 9/14</b> (2006.01)				
	<b>A61K 9/20</b> (2006.01)				
	<b>A61P 35/00</b> (2006.01)				
(11)	P20231748	(46)		15.03.2024.	
(21)	P20231748T	(22)		29.12.2023.	
(86)	PCT/EP2018057877		28.03.2018.		
(96)	<a href="#">EP 18715593.2</a>		28.03.2018.		
(87)	<a href="#">WO2018178134</a>		04.10.2018.		, En
(97)	EP 3601277, 05.02.2020.		202006, En		
(97)	EP 3601277, 11.10.2023.		202341, En		
(31)	17163830	(32)	30.03.2017.	(33)	EP
(54)	<b>FARMACEUTSKA FORMULACIJA PHARMACEUTICAL FORMULATION</b>				
(73)	Merck Patent GmbH, Frankfurter Strasse 250, 64293 Darmstadt, DE				
(72)	Simon Geissler, Homburger Strasse 56, 61352 Bad Homburg, DE Martina Jeschke, Auf dem Berg 6, 64846 Gross-Zimmern, DE Patrizia Boniforte, Am Katharinenberg 6a, 64665 Alsbach-Haehnlein, DE Markus Weigandt, Trollblumenweg 22, 68259 Mannheim, DE				
(74)	PRODUCTA d.o.o., Zagreb, HR				
(51)	MKP	(10)			<b><a href="#">HR P20231537 T1</a></b>
	<b>C07D 417/14</b> (2006.01)				
	<b>C07D 401/14</b> (2006.01)				
	<b>C07D 403/14</b> (2006.01)				
	<b>A61K 31/4725</b> (2006.01)				
	<b>A61P 15/00</b> (2006.01)				
(11)	P20231537	(46)		15.03.2024.	
(21)	P20231537T	(22)		29.11.2023.	
(96)	<a href="#">EP 20150584.9</a>		01.12.2017.		
(97)	EP 3689868, 05.08.2020.		202032, En		
(97)	EP 3689868, 27.09.2023.		202339, En		
(31)	201662429041 P	(32)	01.12.2016.	(33)	US
	201762540049 P		01.08.2017.		US
(62)	17875354.7 ; 01.12.2017.				
(54)	<b>DERIVATI TETRAHIDRONAFTALENA I TETRAHIDROIZOKINOLINA KAO DEGRADATORI ESTROGENSKIH RECEPTORA</b>				
	TETRAHYDRONAPHTHALENE AND TETRAHYDROISOQUINOLINE DERIVATIVES AS ESTROGEN RECEPTOR DEGRADERS				
(73)	Arvinas Operations, Inc., 5 Science Park, New Haven, CT 06511, US				
(72)	Andrew P. Crew, 2 Winterberry Road, Guilford, CT 06437, US Yimin Qian, 5 Camas Court, Plainsboro, NJ 08536, US				
(51)	MKP	(10)			<b><a href="#">HR P20231673 T1</a></b>
	<b>C07D 471/04</b> (2006.01)				
	<b>A61K 31/519</b> (2006.01)				
	<b>A61P 35/00</b> (2006.01)				
(11)	P20231673	(46)		15.03.2024.	
(21)	P20231673T	(22)		19.12.2023.	
(86)	PCT/IB2020055401		09.06.2020.		
(96)	<a href="#">EP 20742922.6</a>		09.06.2020.		
(87)	<a href="#">WO2020250123</a>		17.12.2020.		
(97)	EP 3980417, 13.04.2022.		202215, En		
(97)	EP 3980417, 27.09.2023.		202339, En		
(31)	201921022971	(32)	10.06.2019.	(33)	IN
	201921022972		10.06.2019.		IN
(54)	<b>INHIBITORI PRMT5 PRMT5 INHIBITORS</b>				
(73)	Lupin Limited, Kalpataru Inspire, 3rd Floor, Off Western Express Highway, Santacruz (East), 400 055 Mumbai, MH, IN				
(72)	Prathap Sreedharan Nair, Lupin Research Park, Lupin Ltd., Survey No. 46 A, 47 A, Village Nande, Taluka Mulshi, 412115 Pune, MH, IN Ganesh Bhausaheb Gudade, Lupin Research Park, Lupin Ltd., Survey No. 46 A, 47 A, Village Nande, Taluka Mulshi, 412115 Pune, MH, IN Mahadeo Bhaskar Tryambake, Lupin Research Park, Lupin Ltd., Survey No. 46 A, 47 A, Village Nande, Taluka Mulshi, 412115 Pune, MH, IN Chetan Sanjay Pawar, Lupin Research Park, Lupin Ltd., Survey No. 46 A, 47 A, Village Nande, Taluka Mulshi, 412115 Pune, MH, IN Dipak Raychand Lagad, Lupin Research Park, Lupin Ltd., Survey No. 46 A, 47 A, Village Nande, Taluka Mulshi, 412115 Pune, MH, IN Chaitanya Prabhakar Kulkarni, Lupin Research Park, Lupin Ltd., Survey No. 46 A, 47 A, Village Nande, Taluka Mulshi, 412115 Pune, MH, IN Milind Dattatraya Sindkhedkar, Lupin Research Park, Lupin Ltd., Survey No. 46 A, 47 A, Village Nande, Taluka Mulshi, 412115 Pune, MH, IN Venkata P. Palle, Lupin Research Park, Lupin Ltd., Survey No. 46 A, 47 A, Village Nande, Taluka Mulshi, 412115 Pune, MH, IN Rajender Kumar Kamboj, Lupin Research Park, Lupin Ltd., Survey No. 46 A, 47 A, Village Nande, Taluka Mulshi, 412115 Pune, MH, IN				
(74)	ZMP IP d.o.o., Zagreb, HR				
(51)	MKP	(10)			<b><a href="#">HR P20231654 T1</a></b>
	<b>C07D 471/18</b> (2006.01)				
	<b>A61P 31/18</b> (2006.01)				
(11)	P20231654	(46)		15.03.2024.	
(21)	P20231654T	(22)		15.12.2023.	
(86)	PCT/US2022012773		18.01.2022.		
(96)	<a href="#">EP 22704452.6</a>		18.01.2022.		
(87)	<a href="#">WO2022159387</a>		28.07.2022.		
(97)	EP 4196479, 21.06.2023.		202325, En		
(97)	EP 4196479, 01.11.2023.		202344, En		
(31)	202163139237 P	(32)	19.01.2021.	(33)	US
	202163190461 P		19.05.2021.		US
(54)	<b>SUPSTITUIRANI SPOJEVI PIRIDOTRIAZINA I NIHOVE UPORABE</b>				
	SUBSTITUTED PYRIDOTRIAZINE COMPOUNDS AND USES THEREOF				
(73)	GILEAD SCIENCES, INC., 333 Lakeside Drive, Foster City, CA 94404, US				
(72)	Hang Chu, Foster City, CA 94404, US Ana Z. Gonzalez Buenrostro, Foster City, CA 94404, US Hongyan Guo, Foster City, CA 94404, US Xiaochun Han, Foster City, CA 94404, US Anna E. Hurlley, Foster City, CA 94404, US Lan Jiang, Foster City, CA 94404, US Jiayao Li, Foster City, CA 94404, US David W. Lin, Foster City, CA 94404, US Michael L. Mitchell, Foster City, CA 94404, US Devan Naduthambi, Foster City, CA 94404, US Gregg M. Schwarzwald, Foster City, CA 94404, US Suzanne M. Szweczyk, San Mateo, CA 94402, US Matthew J. Von Bargen, Redwood City, CA 94065, US Qiaoyin Wu, Foster City, CA 94404, US Hong Yang, Foster City, CA 94404, US				

Jennifer R. Zhang, Foster City, CA 94404, US  
(74) Vukmir i suradnici odvjetničko društvo d.o.o., Zagreb, HR

(51) MKP (10) [HR P20231614 T1](#)  
**C07D 487/04** (2006.01)  
**A61P 35/00** (2006.01)  
**A61K 31/519** (2006.01)  
**C07D 403/04** (2006.01)  
**C07D 403/14** (2006.01)

(11) P20231614 (46) 15.03.2024.  
(21) P20231614T (22) 11.12.2023.

(86) PCT/US2017024270 27.03.2017.  
(96) [EP 17715620.5](#) 27.03.2017.  
(87) [WO2017172596](#), 05.10.2017.  
(97) EP 3436461, 06.02.2019. 201906, En  
(97) EP 3436461, 01.11.2023. 202344, En

(31) 201662314066 P (32) 28.03.2016. (33) US  
201662362934 P 15.07.2016. US  
201662438750 P 23.12.2016. US

(54) **SPOJEVI PIROLOTRIAZINA KAO TAM INHIBITORI**  
**PYRROLOTRIAZINE COMPOUNDS AS TAM INHIBITORS**

(73) Incyte Corporation, 1801 Augustine Cut-off, Wilmington, DE 19803, US

(72) Yun-Long Li, Incyte Corporation, 1801 Augustine Cut-Off, Wilmington, DE 19803, US  
Xiaozhao Wang, Incyte Corporation, 1801 Augustine Cut-Off, Wilmington, DE 19803, US  
Joseph Barbosa, Incyte Corporation, 1801 Augustine Cut-Off, Wilmington, DE 19803, US  
David M. Burns, Incyte Corporation, 1801 Augustine Cut-Off, Wilmington, DE 19803, US  
Hao Feng, Incyte Corporation, 1801 Augustine Cut-Off, Wilmington, DE 19803, US  
Joseph Glenn, Incyte Corporation, 1801 Augustine Cut-Off, Wilmington, DE 19803, US  
Chunhong He, Incyte Corporation, 1801 Augustine Cut-Off, Wilmington, DE 19803, US  
Taisheng Huang, Incyte Corporation, 1801 Augustine Cut-Off, Wilmington, DE 19803, US  
Song Mei, Incyte Corporation, 1801 Augustine Cut-Off, Wilmington, DE 19803, US  
Jincong Zhuo, Incyte Corporation, 1801 Augustine Cut-Off, Wilmington, DE 19803, US

(74) Vukmir i suradnici odvjetničko društvo d.o.o., Zagreb, HR

(51) MKP (10) [HR P20231563 T1](#)  
**C07D 495/04** (2006.01)  
**A61K 31/5025** (2006.01)  
**A61P 9/10** (2006.01)  
**A61P 17/00** (2006.01)  
**A61P 13/12** (2006.01)  
**A61Q 19/08** (2006.01)

(11) P20231563 (46) 15.03.2024.  
(21) P20231563T (22) 01.12.2023.

(96) [EP 20188323.8](#) 21.06.2017.  
(97) EP 3757107, 30.12.2020. 202053, En  
(97) EP 3757107, 25.10.2023. 202343, En

(31) 201662352784 P (32) 21.06.2016. (33) US

(62) 17816127.9 ; 21.06.2017.

(54) **4-OKSO-3,4-DIHDROTINO[3,4-D]PIRIDAZINSKI SPOJEVI KAO INHIBITORI ALDOSOREDUKTAZE I NAČINI NJIHOVE UPOTREBE**  
**4-OXO-3,4-DIHYDROTHIENO[3,4-D]PYRIDAZINE COMPOUNDS AS ALDOSE REDUCTASE INHIBITORS AND METHODS OF USE THEREOF**

(73) The Trustees of Columbia University in the City of New York, 412 Low Memorial Library, 535 West 116th Street, New York, NY 10027, US

(72) Andrew Wasmuth, Brooklyn, NY 11201, US  
Donald W. Landry, New York, NY 10027, US

(74) Danija Budimir, Zagreb, HR

(51) MKP (10) [HR P20231668 T1](#)  
**C07F 9/38** (2006.01)

(11) P20231668 (46) 15.03.2024.  
(21) P20231668T (22) 18.12.2023.

(86) PCT/IB2020055304 05.06.2020.  
(96) [EP 20736424.1](#) 05.06.2020.  
(87) [WO2020245780](#), 10.12.2020.

(97) EP 3980434, 13.04.2022. 202215, En  
(97) EP 3980434, 04.10.2023. 202340, En

(31) 201900008391 (32) 07.06.2019. (33) IT

(54) **POSTUPAK ZA PRIPRAVU POLIMORFA F NATRIJEVOG NERIDRONATA**  
**PROCESS FOR THE PREPARATION OF THE POLYMORPH F OF SODIUM NERIDRONATE**

(73) Abiogen Pharma S.p.A., Via Meucci 36-Loc. Ospedaletto, 56121 Pisa, IT

(72) Fabio Neggiani, Via Randaccio, 12, 56123 Pisa, IT  
Stefano Luca Giaffreda, Via Camillo Benso Conte di Cavour 94/A, 40026 Imola, IT  
Serena Fabbroni, Via San Vitale Est, 139, 40059 Medicina, IT  
Michel Chiarucci, Via Villanova, 2/3, 40055 Castenaso, IT  
Barbara Politi, Via Baracca, 27, 57128 Livorno, IT

(74) ZMP IP d.o.o., Zagreb, HR

(51) MKP (10) [HR P20231582 T1](#)  
**C07J 63/00** (2006.01)  
**A61K 31/58** (2006.01)  
**A61P 31/18** (2006.01)  
**A61K 31/18** (2006.01)

(11) P20231582 (46) 15.03.2024.  
(21) P20231582T (22) 05.12.2023.

(86) PCT/IB2020051048 11.02.2020.  
(96) [EP 20720927.1](#) 11.02.2020.  
(87) [WO2020166574.1](#), 20.08.2020.  
(97) EP 3924361, 22.12.2021. 202151, En  
(97) EP 3924361, 06.09.2023. 202336, En

(31) 201941005217 (32) 11.02.2019. (33) IN

(54) **NOVI DERIVATI TRITERPENA KAO INHIBITORI HIV-A**  
**NOVEL TRITERPENE DERIVATIVES AS HIV INHIBITORS**

(73) Hetero Labs Limited, Plot No: B-80 & 81 A.P.I.E, 500018 Balanagar Hyderabad, IN

(72) Parthasaradhi Reddy Bandi, Plot No B-80 & 81 A.P.I.E, 500018 Balanagar Hyderabad, IN  
Rathnakar Reddy Kura, Plot No B-80 & 81 A.P.I.E, 500018 Balanagar Hyderabad, IN  
Panduranga Reddy Adulla, Plot No B-80 & 81 A.P.I.E, 500018 Balanagar Hyderabad, IN  
Bhaskar Reddy Kasireddy, Plot No B-80 & 81 A.P.I.E, 500018 Balanagar Hyderabad, IN

(74) Vukmir i suradnici odvjetničko društvo d.o.o., Zagreb, HR

(51) MKP (10) [HR P20231544 T1](#)  
**C07K 1/113** (2006.01)  
**C07K 1/34** (2006.01)  
**B01D 15/36** (2006.01)  
**B01D 15/38** (2006.01)

(11) P20231544 (46) 15.03.2024.  
(21) P20231544T (22) 29.11.2023.

(86) PCT/US2016046929 12.08.2016.  
(96) [EP 16757780.8](#) 12.08.2016.  
(87) [WO201702786.1](#), 16.02.2017.  
(97) EP 3334747, 20.06.2018. 201825, En  
(97) EP 3334747, 27.09.2023. 202339, En

(31) 201562204831 P (32) 13.08.2015. (33) US

(54) **NABIJENA DUBINSKA FILTRACIJA PROTEINA KOJI VEŽU ANTIGENE**  
**CHARGED DEPTH FILTRATION OF ANTIGEN-BINDING PROTEINS**

(73) Amgen Inc., One Amgen Center Drive, Thousand Oaks, CA 91320-1799, US

(72) Hai Hoang, 106 College Ave., Unit 1F, Somerville, MA 02142, US  
Rafael Gonzalez, 124 Cindy Ave., Thousand Oaks, CA 91320, US  
Junfen Ma, 1831 Red Robin Place, Thousand Oaks, CA 91320, US

(74) PRODUCTA d.o.o., Zagreb, HR

(51) MKP (10) [HR P20231631 T1](#)  
**C07K 14/33** (2006.01)  
**A61K 39/08** (2006.01)  
**C07K 16/12** (2006.01)

(11) P20231631 (46) 15.03.2024.  
(21) P20231631T (22) 12.12.2023.

(96) [EP 19151036.1](#) 20.04.2012.  
(97) EP 3505531, 03.07.2019. 201927, En  
(97) EP 3505531, 15.11.2023. 202346, En

(31) 201161478474 P (32) 22.04.2011. (33) US

	201161478899 P	25.04.2011.	US	
(62)	12720966.6	20.04.2012.		
(54)	<b>PRIPRAVCI KOJI SE ODNOSE NA MUTANTNI TOKSIN IZ BAKTERIJE CLOSTRIDIUM DIFFICILE I ODGOVARAJUĆI POSTUPCI</b>			
	COMPOSITIONS RELATING TO A MUTANT CLOSTRIDIUM DIFFICILE TOXIN AND METHODS THEREOF			
(73)	Wyeth LLC, 66 Hudson Boulevard East, New York, NY 10001-2192, US			
(72)	Maninder K. Sidhu, 18 Shepherds Hill Drive, Bangor, PA 18013, US Annaliesa Sybil Anderson, 49 Hillcrest Drive, Upper Saddle River, NJ 07458, US Robert G.K. Donald, 129 Kenneth Terrace, South Orange, NJ 07079, US Kathrin Ute Jansen, 57 Heather Court, Allendale, NJ 07401, US Narender K. Kalyan, 232 North Walnut Street, Ridgewood, NJ 07450, US Terri L. Mininni, 1 Pieters Court, New Windsor, NY 12553, US Justin Keith Moran, 682 Sierra Vista Lane, Valley Cottage, NY 10989, US Mark E. Ruppen, 6 Lea Court, Garnerville, NY 10923, US Michael James Flint, 860 Briarcliff Road NE, Apt 9, Atlanta, GA 30306, US			
(74)	Hraste & Partneri odvjetničko društvo d.o.o., Zagreb, HR			
(51)	MKP	(10)	<a href="#">HR P20231567 T1</a>	
	<b>C07K 14/72</b> (2006.01) <b>A61K 38/08</b> (2019.01) <b>A61K 38/10</b> (2006.01) <b>C07K 7/06</b> (2006.01) <b>C07K 7/08</b> (2006.01)			
(11)	P20231567	(46)		15.03.2024.
(21)	P20231567T	(22)		04.12.2023.
(86)	PCT/FR2017052788 11.10.2017.			
(96)	<a href="#">EP 17794365.1</a> 11.10.2017.			
(87)	<a href="#">WO2018069641</a> , 19.04.2018.			
(97)	EP 3526244, 21.08.2019. 201934, Fr			
(97)	EP 3526244, 06.09.2023. 202336, Fr			
(31)	1659781	(32)	11.10.2016.	(33) FR
	1752162		16.03.2017.	FR
	1754127		11.05.2017.	FR
(54)	<b>PEPTIDI IZVEDENI IZ PROPEPTIDA NTSR3 I NJIHOVA UPORABA U LJEČENJU DEPRESIJE</b>			
	PEPTIDES DERIVED FROM THE PROPEPTIDE NTSR3 AND THEIR USE IN THE TREATMENT OF DEPRESSION			
(73)	Centre National de la Recherche Scientifique, 3, rue Michel-Ange, 75016 Paris, FR Université Côte d'Azur, Grand Château, 28 avenue Valrose, BP 2135, 06100 Nice Cedex 2, FR			
(72)	Jean Mazella, 1380 chemin des Vignasses, 06410 Biot, FR Marc Borsotto, 47 boulevard Emmanuel Rouquier, 06130 Grasse, FR Catherine Heurteaux, 7 domaine de la Vallière 230 chemin Notre Dame, 06480 La-Colle-Sur-Loup, FR Alaeddine Djillani, 167 Cité des 360 logements, 19200 Aïn-Oulmene Setif, DZ Sébastien Moreno, 1211 chemin de Vosgelade, 06140 Vence, FR Mariel Pietri, 9 rue Docteur Pompeani, 20000 Ajaccio, FR			
(74)	Vukmir i suradnici odvjetničko društvo d.o.o., Zagreb, HR			
(51)	MKP	(10)	<a href="#">HR P20231645 T1</a>	
	<b>C07K 14/725</b> (2006.01)			
(11)	P20231645	(46)		15.03.2024.
(21)	P20231645T	(22)		13.12.2023.
(86)	PCT/GB2017050805 22.03.2017.			
(96)	<a href="#">EP 17715521.5</a> 22.03.2017.			
(97)	<a href="#">WO2017163064</a> , 28.09.2017. , En			
(97)	EP 3433270, 30.01.2019. 201905, En			
(97)	EP 3433270, 20.09.2023. 202338, En			
(31)	201604953	(32)	23.03.2016.	(33) GB
(54)	<b>T STANIČNI RECEPTORI</b>			
	T CELL RECEPTORS			
(73)	Immunocore Limited, 92 Park Drive, Milton Park, OX14 4RY Abingdon, Oxfordshire, GB			
(72)	Tara Mahon, c/o Immunocore Limited, 101 Milton Park, OX14 4RY Abingdon Oxfordshire, GB Yi Li, c/o Immunocore Limited, 101 Milton Park, OX14 4RY Abingdon Oxfordshire, GB			
(74)	ZMP IP d.o.o., Zagreb, HR			
(51)	MKP	(10)	<a href="#">HR P20231739 T1</a>	
	<b>C07K 16/08</b> (2006.01) <b>A61P 13/12</b> (2006.01) <b>A61P 31/12</b> (2006.01) <b>A61P 31/20</b> (2006.01) <b>A61P 37/06</b> (2006.01)			
(11)	P20231739	(46)		15.03.2024.
(21)	P20231739T	(22)		28.12.2023.
(86)	PCT/EP2021065462 09.06.2021.			
(96)	<a href="#">EP 21730952.5</a> 09.06.2021.			
(87)	<a href="#">WO2021250097</a> , 16.12.2021.			
(97)	EP 4126932, 08.02.2023. 202306, En			
(97)	EP 4126932, 15.11.2023. 202346, En			
(31)	20179041	(32)	09.06.2020.	(33) EP
	20179044		09.06.2020.	EP
(54)	<b>MOLEKULE ANTITIJELA VIRUSA ANTI-BK</b>			
	ANTI-BK VIRUS ANTIBODY MOLECULES			
(73)	Memo Therapeutics AG, Wagistrasse 27, 8952 Schlieren, CH Universität Bern, Verwaltungsdirektion, Hochschulstrasse 6, 3012 Bern, CH Universität Zürich, Prorektorat Forschung, Rämistrasse 71, 8006 Zürich, CH			
(72)	Marcel Weber, 8037 Zürich, CH Simone Schmitt, 8953 Dietikon, CH Christoph Esslinger, 8032 Zürich, CH Thomas Schachtner, 8001 Zürich, CH Uyen Huynh-do, 3097 Liebefeld, CH Maurizio Provenzano, 5708 Birrwil, CH			
(74)	ZMP IP d.o.o., Zagreb, HR			
(51)	MKP	(10)	<a href="#">HR P20231578 T1</a>	
	<b>C07K 16/28</b> (2006.01) <b>A61K 39/395</b> (2006.01) <b>A61K 39/00</b> (2006.01)			
(11)	P20231578	(46)		15.03.2024.
(21)	P20231578T	(22)		05.12.2023.
(86)	PCT/US2016063518 23.11.2016.			
(96)	<a href="#">EP 16810195.4</a> 23.11.2016.			
(87)	<a href="#">WO2017091683</a> , 01.06.2017.			
(97)	EP 3380522, 03.10.2018. 201840, En			
(97)	EP 3380522, 08.11.2023. 202345, En			
(31)	201562259897 P	(32)	25.11.2015.	(33) US
	201662313684 P		25.03.2016.	US
	201662399087 P		23.09.2016.	US
	201662422848 P		16.11.2016.	US
(54)	<b>MOLEKULE PROTUTIJELA NA APRIL I NJIHOVE UPORABE</b>			
	ANTIBODY MOLECULES TO APRIL AND USES THEREOF			
(73)	Visterra, Inc., 275 2nd Avenue, 4th Floor, Waltham, MA 02451, US			
(72)	James R. Myette, 33 Winthrop Street, Waltham, MA 02453, US Zachary Holmes Shriver, 21 Mount Pleasant Street, Winchester, MA 01890, US Karthik Viswanathan, 1 John Swift Road, Acton, MA 01720, US Andrew M. Wollacott, 16 Woodchester Drive, Milton, MA 02186, US Hedy Adari-Hall, 17 Emerson Way, Sudbury, MA 01776, US Boopathy Ramakrishnan, 605 Middle Street Unit 19, Braintree, MA 02184, US Gregory Babcock, 38 Muir Way, Marlborough, MA 01752, US			
(74)	Vukmir i suradnici odvjetničko društvo d.o.o., Zagreb, HR			
(51)	MKP	(10)	<a href="#">HR P20231645 T1</a>	
	<b>C07K 14/725</b> (2006.01)			
(11)	P20231645	(46)		15.03.2024.
(21)	P20231645T	(22)		13.12.2023.
(86)	PCT/GB2017050805 22.03.2017.			
(96)	<a href="#">EP 17715521.5</a> 22.03.2017.			
(97)	<a href="#">WO2017163064</a> , 28.09.2017. , En			
(97)	EP 3433270, 30.01.2019. 201905, En			
(97)	EP 3433270, 20.09.2023. 202338, En			
(31)	201604953	(32)	23.03.2016.	(33) GB
(54)	<b>T STANIČNI RECEPTORI</b>			
	T CELL RECEPTORS			
(73)	Immunocore Limited, 92 Park Drive, Milton Park, OX14 4RY Abingdon, Oxfordshire, GB			
(72)	Tara Mahon, c/o Immunocore Limited, 101 Milton Park, OX14 4RY Abingdon Oxfordshire, GB Yi Li, c/o Immunocore Limited, 101 Milton Park, OX14 4RY Abingdon Oxfordshire, GB			
(74)	ZMP IP d.o.o., Zagreb, HR			
(51)	MKP	(10)	<a href="#">HR P20231579 T1</a>	
	<b>C07K 16/28</b> (2006.01) <b>A61K 39/00</b> (2006.01) <b>A61P 11/00</b> (2006.01) <b>A61P 35/04</b> (2006.01)			
(11)	P20231579	(46)		15.03.2024.
(21)	P20231579T	(22)		05.12.2023.
(86)	PCT/US2017065011 07.12.2017.			
(96)	<a href="#">EP 17818406.5</a> 07.12.2017.			
(87)	<a href="#">WO2018106862</a> , 14.06.2018.			
(97)	EP 3551660, 16.10.2019. 201942, En			
(97)	EP 3551660, 13.09.2023. 202337, En			
(31)	201662431272 P	(32)	07.12.2016.	(33) US
(54)	<b>ANTI-CTLA-4 ANTITIJELA I POSTUPCI NJIHOVE UPOTREBE</b>			
	ANTI-CTLA-4 ANTIBODIES AND METHODS OF USE THEREOF			
(73)	Agenus Inc., 3 Forbes Road, Lexington, MA 02421, US Ludwig Institute for Cancer Research Ltd, Stadelhoferstrasse 22, 8001 Zürich, CH Memorial Sloan Kettering Cancer Center, 1275 York Avenue, New York, NY 10065, US			

- (72) Marc Van Dijk, Tolhuislaan 8A, 3735 KG Bosch en Duin, NL  
Cornelia Anne Mundt, Hangstrasse 34, 79539 Lörrach, DE  
Gerd Ritter, c/o Ludwig Institute for Cancer Research, 666 Third Avenue, New York, NY 10017, US  
David Schaer, 715 Shore Acres Drive, Mamaroneck, NY 10543, US  
Jedd David Wolchok, 333 E. 30th Street, Apt. 17C, New York, NY 10016, US  
Taha Merghoub, 10 Huron Avenue, Apt. 14K, Jersey City, NJ 07306, US  
Nicholas Stuart Wilson, 292 Grove Street, Medford, MA 02155, US  
David Adam Savitsky, 28 Sunrise Road, Boxford, MA 01921, US  
Mark Arthur Findeis, 431 School Street, Belmont, MA 02478, US  
Dennis John Underwood, 28 John A. Andrew Street, Boston, MA 02130, US  
Jean-Marie Cuillerot, 5 Tower Court, Apt. 4, Somerville, MA 02143, US  
Igor Proscurshim, 1193 Curve Street, Carlisle, MA 01741, US  
Olga Shebanova, 13 Malvern Avenue 1, Somerville, MA 02144, US
- (74) ZMP IP d.o.o., Zagreb, HR
- 
- (51) MKP (10) [HR P20231609 T1](#)  
**C07K 16/28** (2006.01)  
**C07K 16/30** (2006.01)  
**A61K 47/68** (2017.01)  
**A61P 35/00** (2006.01)  
**A61K 31/40** (2006.01)
- (11) P20231609 (46) 15.03.2024.  
(21) P20231609T (22) 08.12.2023.
- (86) PCT/EP2016058056 13.04.2016.  
(96) [EP 16715583.7](#) 13.04.2016.  
(87) [WO2016166122](#), 20.10.2016., En  
(97) EP 3283521, 21.02.2018. 201808, En  
(97) EP 3283521, 15.11.2023. 202346, En  
(31) PCT/EP2015/058206 (32) 15.04.2015. (33) WO
- (54) **KONJUGATI LIJEKA KOJI SADRŽE ANTITIJELA PROTIV KLAUDINA 18.2**  
DRUG CONJUGATES COMPRISING ANTIBODIES AGAINST CLAUDIN 18.2
- (73) Astellas Pharma Inc., 5-1, Nihonbashi-Honcho 2-Chome, Chuo-ku, 103-8411 Tokyo, JP  
TRON - Translationale Onkologie an der Universitätsmedizin der Johannes Gutenberg- Universität Mainz gemeinnützige GmbH, Freiligrathstrasse 12, 55131 Mainz, DE
- (72) Ugur Sahin, Philipp-Von-Zabern-Platz 1, 55116 Mainz, DE  
Özlem Türeci, Philipp-Von-Zabern-Platz 1, 55116 Mainz, DE  
Korden Walter, Pater-Markert-Weg 15, 55291 Saulheim, DE  
Maria Kreuzberg, Obere Zahlbacher Strasse 66, 55131 Mainz, DE  
Rita Mitnacht-Kraus, Taunusstrasse 45, 61169 Friedberg, DE  
Fabrice Le Gall, Gonsbachblick 29, 55122 Mainz, DE  
Stefan Jacobs, Wespenweg 13, 55128 Mainz, DE
- (74) ZMP IP d.o.o., Zagreb, HR
- 
- (51) MKP (10) [HR P20231542 T1](#)  
**C07K 19/00** (2006.01)  
**C12N 5/10** (2006.01)  
**A61K 39/395** (2006.01)  
**A61P 35/00** (2006.01)  
**A61P 35/02** (2006.01)  
**C07K 14/725** (2006.01)  
**C07K 14/705** (2006.01)  
**C07K 16/28** (2006.01)  
**C07K 16/30** (2006.01)  
**C12N 15/62** (2006.01)  
**A61P 7/00** (2006.01)  
**C07K 14/435** (2006.01)
- (11) P20231542 (46) 15.03.2024.  
(21) P20231542T (22) 29.11.2023.
- (96) [EP 21166662.3](#) 10.08.2017.  
(97) EP 3896091, 20.10.2021. 202142, En  
(97) EP 3896091, 27.09.2023. 202339, En  
(31) PCT/CN2016/094408 (32) 10.08.2016. (33) WO  
(62) 17838777.5 ; 10.08.2017.
- (54) **KIMERNI ANTIGENSKI RECEPTORI KOJI CILJAJU BCMA I POSTUPCI NJIHOVE UPORABE**  
CHIMERIC ANTIGEN RECEPTORS TARGETING BCMA AND METHODS OF USE THEREOF
- (73) Legend Biotech Ireland Limited, One Spencer Dock, North Wall Quay, Dublin 1, IE
- (72) Xiaohu Fan, 1067 Armitage Crescent SW, Edmonton, AB T6W 0K3, CA
- Qiuchuan Zhuang, Room 104, 36th Building, Yuecheng International Garden, No.9 Huashen Street, Yuhuatai District, 210012 Nanjing, Jiangsu, CN  
Pingyan Wang, Wudian Town, 233113 Fengyang, Anhui, CN  
Lin Wang, Room 207 12th Building, 151 Shuangbai Alley, Xuanwu District, 211100 Nanjing, Jiangsu, CN  
Lei Yang, Pingshan Street, Xiejiaji District, 232052 Huainan, Anhui, CN  
Jiaying Hao, Zhushan Road 378, Wanxin Garden, Jiangning District, 211100 Nanjing, Jiangsu, CN  
Dan Zhao, No.2 Building of Guyangxincun Community, Dingmao Road, Jingkou District, 212001 Zhenjiang, Jiangsu, CN  
Xian He, No.15 Tongxianggongjing, Qinhuai District, 210006 Nanjing, Jiangsu, CN
- (74) ZMP IP d.o.o., Zagreb, HR
- 
- (51) MKP (10) [HR P20231536 T1](#)  
**C07K 7/00** (2006.01)  
**C07K 14/00** (2006.01)  
**C07K 16/00** (2006.01)  
**C07K 17/00** (2006.01)  
**C07H 21/00** (2006.01)  
**G01N 33/543** (2006.01)  
**C40B 70/00** (2006.01)  
**B82Y 5/00** (2011.01)
- (11) P20231536 (46) 15.03.2024.  
(21) P20231536T (22) 28.11.2023.
- (96) [EP 19196019.4](#) 24.02.2016.  
(97) EP 3650459, 13.05.2020. 202020, En  
(97) EP 3650459, 06.09.2023. 202336, En  
(31) 201562120262 P (32) 24.02.2015. (33) US  
(62) 16756316.2 ; 24.02.2016.
- (54) **PLATFORME ZA PREGLED KEMIJSKI KODIRANIH PROSTORNO ADRESIRANIH BIBLIOTEKA**  
CHEMICALLY ENCODED SPATIALLY ADDRESSED LIBRARY SCREENING PLATFORMS
- (73) City of Hope, 1500 East Duarte Road, Duarte, CA 91010, US  
(72) Jacob Berlin, 1074 Norumbega Dr., Monrovia, CA 91016, US  
Gregory Copeland, 785 W. 9th St., Claremont, CA 91711, US  
Kathleen Elison, 2784 N. Sierra Way, San Bernardino, CA 92405, US  
Hurik Muradyan, 1506 Glenwood Road, Glendale, CA 91201, US
- (74) ZMP IP d.o.o., Zagreb, HR
- 
- (51) MKP (10) [HR P20231727 T1](#)  
**C12M 1/00** (2006.01)  
**C12M 1/12** (2006.01)
- (11) P20231727 (46) 15.03.2024.  
(21) P20231727T (22) 27.12.2023.
- (86) PCT/EP2017071702 30.08.2017.  
(96) [EP 17765365.6](#) 30.08.2017.  
(87) [WO2018041859](#), 08.03.2018.  
(97) EP 3507357, 10.07.2019. 201928, De  
(97) EP 3507357, 11.10.2023. 202341, De  
(31) 16186440 (32) 30.08.2016. (33) EP  
17155258 08.02.2017. EP
- (54) **FOTOBIOREAKTOR SA POKRETNIM UREDAJEM ZA ODRŽAVANJE**  
PHOTOBIOREACTOR AND METHOD FOR CULTIVATING MICROALGAE
- (73) Beco Invest B.V., Fortweg 3, 3992 LX Houten, NL  
(72) Franz Emminger, Steinerweg 2, 2410 Hainburg, AT  
Silvia Fluch, Markt 8, 7121 Weiden/See, AT
- (74) ZMP IP d.o.o., Zagreb, HR
- 
- (51) MKP (10) [HR P20231664 T1](#)  
**C12N 15/09** (2006.01)  
**C07K 16/28** (2006.01)  
**C12N 5/00** (2006.01)  
**A61K 39/395** (2006.01)  
**C12P 21/08** (2006.01)  
**A61P 31/12** (2006.01)  
**A61P 35/00** (2006.01)  
**A61P 37/04** (2006.01)
- (11) P20231664 (46) 15.03.2024.  
(21) P20231664T (22) 18.12.2023.
- (86) PCT/CN2016093560 05.08.2016.  
(96) [EP 16832346.7](#) 05.08.2016.  
(87) [WO2017020858](#), 09.02.2017.



(97)	EP 3332006, 13.06.2018. 201824, En		
(97)	EP 3332006, 11.10.2023. 202341, En		
(31)	PCT/CN2015/086216 (32) 06.08.2015.	(33)	WO
(54)	<b>NOVA ANTI-PD-L1 ANTITIJELA</b> NOVEL ANTI-PD-L1 ANTIBODIES		
(73)	WuXi Biologics (Shanghai) Co., Ltd., 288 Fute Zhong Road, Waigaoqiao Free Trade Zone, 200131 Shanghai, CN WuXi Biologics Ireland Limited, Mullagharlin, A91 X56F Dundalk, Co Louth, IE		
(72)	Yong Zheng, Room601, No48, Lane618, Qingtong Road, Pudong District, 201203 Shanghai, CN Jing Li, 11 Dunham Street, Lexington, MA 02420, US Zhisheng Chen, 128 Longrui Rd, 10-803 Xuhui District, 200131 Shanghai, CN		
(74)	ZMP IP d.o.o., Zagreb, HR		
<hr/>			
(51)	MKP (10)		<a href="#"><u>HR P20231637 T1</u></a>
	<b>C12N 15/11</b> (2006.01)		
	<b>C07K 14/705</b> (2006.01)		
	<b>C12Q 1/6883</b> (2018.01)		
(11)	P20231637 (46)		15.03.2024.
(21)	P20231637T (22)		13.12.2023.
(86)	PCT/US2018048031 24.08.2018.		
(96)	<a href="#"><u>EP 18848036.2</u></a> 24.08.2018.		
(87)	<a href="#"><u>WO2019040923</u></a> , 28.02.2019.		
(97)	EP 3673080, 01.07.2020. 202027, En		
(97)	EP 3673080, 18.10.2023. 202342, En		
(31)	201762550462 P (32) 25.08.2017.	(33)	US
	201762575901 P 23.10.2017.		US
	201862667356 P 04.05.2018.		US
	201862671745 P 15.05.2018.		US
(54)	<b>ANTISENS OLIGOMERI ZA LIJEČENJE STANJA I BOLESTI</b> ANTISENSE OLIGOMERS FOR TREATMENT OF CONDITIONS AND DISEASES		
(73)	Stoke Therapeutics, Inc., 45 Wiggins Avenue, Bedford, MA 01730, US		
(72)	Isabel Aznarez, Boston, MA 02130, US Zhou Han, Natick, MA 01760, US		
(74)	Danija Budimir, Zagreb, HR		
<hr/>			
(51)	MKP (10)		<a href="#"><u>HR P20231606 T1</u></a>
	<b>C12N 15/113</b> (2010.01)		
(11)	P20231606 (46)		15.03.2024.
(21)	P20231606T (22)		07.12.2023.
(86)	PCT/US2017054540 29.09.2017.		
(96)	<a href="#"><u>EP 17857565.0</u></a> 29.09.2017.		
(87)	<a href="#"><u>WO2018064593</u></a> , 05.04.2018.		
(97)	EP 3519572, 07.08.2019. 201932, En		
(97)	EP 3519572, 22.11.2023. 202347, En		
(31)	201662401723 P (32) 29.09.2016.	(33)	US
	201762450469 P 25.01.2017.		US
(54)	<b>SPOJEVI I METODE ZA SMANJENJE EKSPRESIJE TAU</b> COMPOUNDS AND METHODS FOR REDUCING TAU EXPRESSION		
(73)	Biogen MA Inc., 225 Binney Street, Cambridge, MA 02142, US		
(72)	Holly Kordasiewicz, 2855 Gazelle Ct., Carlsbad, CA 92010, US		
(74)	ZMP IP d.o.o., Zagreb, HR		
<hr/>			
(51)	MKP (10)		<a href="#"><u>HR P20231749 T1</u></a>
	<b>C12N 15/62</b> (2006.01)		
	<b>C07K 14/33</b> (2006.01)		
	<b>A61K 39/08</b> (2006.01)		
	<b>A61K 39/00</b> (2006.01)		
	<b>C07K 16/12</b> (2006.01)		
	<b>C12N 15/70</b> (2006.01)		
(11)	P20231749 (46)		15.03.2024.
(21)	P20231749T (22)		29.12.2023.
(96)	<a href="#"><u>EP 19179871.9</u></a> 25.05.2012.		
(97)	EP 3564378, 06.11.2019. 201945, En		
(97)	EP 3564378, 01.11.2023. 202344, En		
(31)	201161490707 P (32) 27.05.2011.	(33)	US
	201161490716 P 27.05.2011.		US
	201161490734 P 27.05.2011.		US
(62)	12726374.7 ; 25.05.2012.		
(54)	<b>IMUNOGENI PRIPRAVAK</b> IMMUNOGENIC COMPOSITION		
(565)	GlaxoSmithKline Biologicals SA, Rue de l'Institut, 89, 1330 Rixensart, BE		
(72)	Cindy Castado, GlaxoSmithKline Biologicals S.A., Rue de l'Institut 89, 1330 Rixensart, BE		
(74)	ZMP IP d.o.o., Zagreb, HR		
<hr/>			
(51)	MKP (10)		<a href="#"><u>HR P20231666 T1</u></a>
	<b>E02F 9/28</b> (2006.01)		
	<b>E02F 9/26</b> (2006.01)		
(11)	P20231666 (46)		15.03.2024.
(21)	P20231666T (22)		18.12.2023.
(96)	<a href="#"><u>EP 20158245.9</u></a> 12.07.2012.		
(97)	EP 3680401, 15.07.2020. 202029, En		
(97)	EP 3680401, 04.10.2023. 202340, En		
(31)	201161507726 P (32) 14.07.2011.	(33)	US
	201161576929 P 16.12.2011.		US
(62)	12811238.0 ; 12.07.2012.		
(54)	<b>BRAVA ZA TROŠNI SKLOP</b> A LOCK FOR A WEAR ASSEMBLY		
(73)	ESCO Group LLC, 2141 NW 25th Avenue, Portland, OR 97210, US		
(72)	Mark A. Cheyne, 567 North Buffalo Street, Portland, OR 97217, US Noah Cowgill, 10407 SW 24th Avenue, Portland, OR 97222, US Michael B. Roska, 0344 SW Florida, Portland, OR 97219, US Donald M. Conklin, 4575 SW Upper Drive, Lake Oswego, OR 97035, US Scott H. Zenier, 9318 N. Polk Avenue, Portland, OR 97203, US Chris J. Hainley, 9925 Hw Hoge Street, Portland, OR 97231, US		
(74)	ZMP IP d.o.o., Zagreb, HR		
<hr/>			
(51)	MKP (10)		<a href="#"><u>HR P20231530 T1</u></a>
	<b>E04F 17/02</b> (2006.01)		
	<b>E04F 17/04</b> (2006.01)		
	<b>E04F 19/00</b> (2006.01)		
(11)	P20231530 (46)		15.03.2024.
(21)	P20231530T (22)		28.11.2023.
(86)	PCT/EP2021072931 18.08.2021.		
(96)	<a href="#"><u>EP 21766140.4</u></a> 18.08.2021.		
(87)	<a href="#"><u>WO2022043156</u></a> , 03.03.2022.		
(97)	EP 4204642, 05.07.2023. 202327, De		
(97)	EP 4204642, 18.10.2023. 202342, De		
(31)	102020122560 (32) 28.08.2020.	(33)	DE
(54)	<b>SPOJNICA ZA ROGOVE I PRIČVRSNI SUSTAV KOJI SE SASTOJI OD SPOJNICE ZA ROGOVE I BOČNIH NOSAČA ZA DRŽANJE OKOMITIH CIJEVI KAO ŠTO SU DIMNJACI</b> RAFTER CONNECTOR AND RETAINING SYSTEM CONSISTING OF A RAFTER CONNECTOR AND A LATERAL SUPPORT FOR RETAINING VERTICAL LINES, SUCH AS FLUES		
(73)	Schiedel GmbH, Friedrich-Schiedel-Strasse 2-6, 4542 Nussbach, AT		
(72)	Thomas Elfert, 04668 Leipzig, DE Torsten Paschke, 04828 Plagwitz, DE		
(74)	Vukmir i suradnici odvjetničko društvo d.o.o., Zagreb, HR		
<hr/>			
(51)	MKP (10)		<a href="#"><u>HR P20231724 T1</u></a>
	<b>E04F 19/08</b> (2006.01)		
	<b>H02G 3/08</b> (2006.01)		
(11)	P20231724 (46)		15.03.2024.
(21)	P20231724T (22)		27.12.2023.
(96)	<a href="#"><u>EP 22181708.3</u></a> 28.06.2022.		
(97)	EP 4112842, 04.01.2023. 202301, De		
(97)	EP 4112842, 15.11.2023. 202346, De		
(31)	202021002335 U (32) 30.06.2021.	(33)	DE
(54)	<b>UREĐAJ S OTVOROM ZA INSPEKCIJU</b> INSPECTION OPENING DEVICE		
(73)	Led-Arena GmbH, Hauptstraße 52, 74629 Pfedelbach, DE		
(72)	Waldemar Chudalla, 74629 Pfedelbach, DE		
(74)	Vukmir i suradnici odvjetničko društvo d.o.o., Zagreb, HR		
<hr/>			
(51)	MKP (10)		<a href="#"><u>HR P20231560 T1</u></a>
	<b>F01N 13/04</b> (2010.01)		
	<b>F01N 13/08</b> (2010.01)		
	<b>F01N 1/16</b> (2006.01)		
	<b>F01N 1/18</b> (2006.01)		
	<b>F16K 1/00</b> (2006.01)		
	<b>F16K 11/08</b> (2006.01)		

(11) P20231560	(46)	15.03.2024.	(72) Guy Danieli, 128/5 Moshe Rachmilevitz Street, 9779137 Jerusalem, IL
(21) P20231560T	(22)	01.12.2023.	Avi Cohen, 8/4 Hadishon Street, 9695608 Jerusalem, IL
(86) PCT/EP2019081533	15.11.2019.		Oren Shalev, 68 Kineret Street, 7770068 Ashdod, IL
(96) <a href="#">EP 19801586.9</a>	15.11.2019.		Mark Funt, 5 Bialik Street, 444485 Kfar Saba, IL
(87) <a href="#">WO2020109036</a>	04.06.2020.		Allan Ring, 15 Harimon Street, 7941100 Mercuz Shapira, IL
(97) EP 3887661, 06.10.2021.	202140, En		Amnon Shkedi, 33 Dganya Street, 3706389 Pardes Hanna Karkur, IL
(97) EP 3887661, 13.09.2023.	202337, En		Dvir Brand, 2A Hamitnahalim Street, 4530643 Hod Hasharon, IL
(31) 18208611	(32) 27.11.2018.	(33) EP	Eyal Shmueli, 22 Gil'ad Street, 7179902 Modi'in-Maccabim-Reut, IL
(54) <b>VENTIL ZA REGULACIJU PROTOKA PLINA I ZVUKA TE SUSTAV ZA ISPUŠNE PLINOVE</b>			Amit Avigdor, 8 Haarava Street Kibbutz, Bahan, IL
<b>GAS FLOW AND SOUND CONTROL VALVE AND EXHAUST GAS SYSTEM</b>			Eran Shaashua, 5 Ha' yasmin Street, 4592500 Adanim, IL
(73) Akrapovic d.d., Malo Hudo 8a, 1295 Ivancna Gorica, SI			Hagai Harduff, 15 Mahagana Street, 3055017 Binyamina, IL
(72) Jure Penca, Zoisova ulica 50b, 1230 Domzale, SI			Doron Krom, 4 B Malchey Yisrael Street, 3092091 Zikhron Yaacov, IL
Igor Akrapovic, Rozna dolina, cesta VII 10/a, 1000 Ljubljana, SI			(74) ZMP IP d.o.o., Zagreb, HR
(74) Vukmir i suradnici odvijetničko društvo d.o.o., Zagreb, HR			

(51) MKP	(10)	<a href="#">HR P20231622 T1</a>
<b>F16B 12/16</b> (2006.01)		
<b>F16B 5/06</b> (2006.01)		
<b>F16B 5/02</b> (2006.01)		
<b>F16B 3/00</b> (2006.01)		
(11) P20231622	(46)	15.03.2024.
(21) P20231622T	(22)	11.12.2023.
(96) <a href="#">EP 18210356.4</a>	14.12.2016.	
(97) EP 3477124, 01.05.2019.	201918, De	
(97) EP 3477124, 27.09.2023.	202339, De	
(31) 102016202450	(32) 17.02.2016.	(33) DE
(62) 16822133.1 ; 14.12.2016.		
(54) <b>SREDSTVO ZA SPAJANJE I POSTUPAK SPAJANJA DVIJE KOMPONENTE</b>		
<b>FIXING MEANS AND METHOD FOR CONNECTING TWO COMPONENTS</b>		
(73) Lamello AG, Hauptstrasse 149, 4416 Bubendorf, CH		
(73)(72) Franz Baur, Hochsträss 13, 87534 Oberstaufen, DE		
Franz Josef Haser, Buchenegg 5, 87534 Oberstaufen, DE		
(72) Patrick Jeker, Holzgasse 14, 4225 Brislach, CH		
Philipp Seiler, Uerdorf 20, 4424 Arboldswil, CH		
(74) ZMP IP d.o.o., Zagreb, HR		

(51) MKP	(10)	<a href="#">HR P20231689 T1</a>
<b>F16B 7/18</b> (2006.01)		
<b>F16B 37/04</b> (2006.01)		
(11) P20231689	(46)	15.03.2024.
(21) P20231689T	(22)	20.12.2023.
(86) PCT/EP2018054299	21.02.2018.	
(96) <a href="#">EP 18707884.5</a>	21.02.2018.	
(87) <a href="#">WO2018153928</a>	30.08.2018.	
(97) EP 3586013, 01.01.2020.	202001, De	
(97) EP 3586013, 04.10.2023.	202340, De	
(31) 102017103769	(32) 23.02.2017.	(33) DE
(54) <b>SKLOP ZA PRIČVRŠČIVANJE</b>		
<b>FASTENING ASSEMBLY</b>		
(73) MÜPRO Services GmbH, Borsigstraße 14, 65205 Wiesbaden, DE		
(72) Dominik Roos, 65510 Idstein Wörsdorf, DE		
Janosch Alt, 66557 Illingen, DE		
Udo Eping, Nussbaumallee 5, 64297 Darmstadt, DE		
(74) ZMP IP d.o.o., Zagreb, HR		

(51) MKP	(10)	<a href="#">HR P20231624 T1</a>
<b>F16K 1/02</b> (2006.01)		
<b>F17C 1/00</b> (2006.01)		
<b>B01F 23/00</b> (2022.01)		
(11) P20231624	(46)	15.03.2024.
(21) P20231624T	(22)	11.12.2023.
(86) PCT/IL2020050002	01.01.2020.	
(96) <a href="#">EP 20804879.3</a>	01.01.2020.	
(87) <a href="#">WO2020230115</a>	19.11.2020.	
(97) EP 3884185, 29.09.2021.	202139, En	
(97) EP 3884185, 27.09.2023.	202339, En	
(31) 201916411870	(32) 14.05.2019.	(33) US
(54) <b>ADAPTER GLAVE ZA PUNJENJE ZA STROJ ZA KARBONIZACIJU</b>		
<b>FILLING HEAD ADAPTER FOR CARBONATION MACHINE</b>		
(73) SodaStream Industries Ltd., 1 Atir Yeda, 4464301 Kfar Saba, IL		

(51) MKP	(10)	<a href="#">HR P20231627 T1</a>
<b>F16L 55/17</b> (2006.01)		
<b>F16L 55/172</b> (2006.01)		
<b>F16J 15/06</b> (2006.01)		
(11) P20231627	(46)	15.03.2024.
(21) P20231627T	(22)	12.12.2023.
(96) <a href="#">EP 21176962.5</a>	31.05.2021.	
(97) EP 4098923, 07.12.2022.	202249, En	
(97) EP 4098923, 18.10.2023.	202342, En	
(54) <b>SPOJNICA ZA POPRAVAK ZA POPRAVAK CJEVOVODA KOJIM MOŽE PROTJECATI TEKUĆINA I ODGOVARAJUĆA METODA</b>		
<b>REPAIR COUPLING TO REPAIR A PIPELINE WHICH CAN BE CROSSED BY A FLUID AND RELEVANT METHOD</b>		
(73) Nova Siria S.r.l., Via Marconi 4/6, 10060 Roletto (TO), IT		
(72) Stefano Corda, 10060 Roletto (TO), IT		
Roberto Serafini, 10060 Roletto (TO), IT		
(74) ZMP IP d.o.o., Zagreb, HR		

(51) MKP	(10)	<a href="#">HR P20231597 T1</a>
<b>F23D 14/32</b> (2006.01)		
<b>F23N 1/02</b> (2006.01)		
<b>F24D 3/00</b> (2022.01)		
<b>F23L 7/00</b> (2006.01)		
<b>F24D 18/00</b> (2022.01)		
(11) P20231597	(46)	15.03.2024.
(21) P20231597T	(22)	06.12.2023.
(86) PCT/EP2019084954	12.12.2019.	
(96) <a href="#">EP 19817719.8</a>	12.12.2019.	
(87) <a href="#">WO2020120699</a>	18.06.2020.	
(97) EP 3894746, 20.10.2021.	202142, Fr	
(97) EP 3894746, 06.09.2023.	202336, Fr	
(31) 1872780	(32) 12.12.2018.	(33) FR
(54) <b>SKLOP KOJI UKLJUČUJE POSTROJENJE ZA IZGARANJE I SUSTAV ZA OPTIMIZACIJU ENERGIJE I OKOLIŠA</b>		
<b>ASSEMBLY COMPRISING A COMBUSTION FACILITY AND AN ENERGY AND ENVIRONMENTAL OPTIMIZATION SYSTEM</b>		
(73) Bulane, 79 rue Mézière Christin, Ecoparc de Fabrègues, 34690 Fabrègues, FR		
(72) Nicolas Jerez, Le Danieli APT 107 909 avenue Léonard de Vinci, 34970 Lattes, FR		
Henri Champseix, 303 chemin du Cambas, 34980 Montferriez sur Lez, FR		
(74) Željka Filipčić, Zagreb, HR		

(51) MKP	(10)	<a href="#">HR P20231601 T1</a>
<b>F23M 7/00</b> (2006.01)		
(11) P20231601	(46)	15.03.2024.
(21) P20231601T	(22)	07.12.2023.
(96) <a href="#">EP 21157453.8</a>	28.10.2015.	
(97) EP 3839345, 23.06.2021.	202125, En	
(97) EP 3839345, 25.10.2023.	202343, En	
(31) 2013697	(32) 28.10.2014.	(33) NL
2015669	27.10.2015.	NL
(62) 15191916.4 ; 28.10.2015.		
(54) <b>IZOLACIJSKI UREĐAJ POKLOPCA PLAMENIKA ZA KOTAO I POSTUPAK ZA PROIZVODNJU TAKVOG UREĐAJA</b>		
<b>BURNER COVER INSULATION DEVICE FOR A BOILER, AND METHOD FOR MANUFACTURING SUCH A DEVICE</b>		
(73) Industrial Ceramic Linings B.V., Innsbruckweg 2, 3047 AH Rotterdam, NL		

(72)	Ike Den Hartogh, Innsbruckweg 2, 3047 AH Rotterdam, NL Remco Tournier, Innsbruckweg 2, 3047 AH Rotterdam, NL Eric Tournier, Innsbruckweg 2, 3047 AH Rotterdam, NL				
(74)	ZMP IP d.o.o., Zagreb, HR				
(51)	MKP <b>F28D 20/00</b> (2006.01)	(10)		<a href="#">HR P20231340 T1</a>	
(11)	P20231340	(46)	15.03.2024.		
(21)	P20231340T	(22)	24.10.2023.		
(96)	<a href="#">EP 20194617.5</a>		04.09.2020.		
(97)	EP 3789196, 10.03.2021.		202110, En		
(97)	EP 3789196, 26.07.2023.		202330, En		
(31)	PA201970563	(32)	09.09.2019.	(33)	DK
(54)	<b>POSTROJENJE ZA SKLADIŠTENJE TOPLINSKE ENERGIJE A THERMAL ENERGY STORAGE PLANT</b>				
(73)	Aalborg CSP A/S, Hjulmagervej 55, 9000 Aalborg, DK RK Projektentwicklungs- und Beteiligungs GmbH, Pernhartgasse 9, 9020 Klagenfurt am Wörthersee, AT				
(72)	Morten Vang Bobach, c/o Aalborg CSP A/S, Hjulmagervej 55, 9000 Aalborg, DK				
(74)	ZMP IP d.o.o., Zagreb, HR				
(51)	MKP <b>F28F 9/02</b> (2006.01) <b>F28F 27/00</b> (2006.01) <b>F16J 15/02</b> (2006.01) <b>F28D 7/16</b> (2006.01)	(10)		<a href="#">HR P20231626 T1</a>	
(11)	P20231626	(46)	15.03.2024.		
(21)	P20231626T	(22)	12.12.2023.		
(86)	PCT/US2019023097		20.03.2019.		
(96)	<a href="#">EP 19771967.7</a>		20.03.2019.		
(87)	<a href="#">WO2019183176</a>		26.09.2019.		
(97)	EP 3759412, 06.01.2021.		202101, En		
(97)	EP 3759412, 25.10.2023.		202343, En		
(31)	201862645662 P	(32)	20.03.2018.	(33)	US
(54)	<b>SKLOPOVI ZA ZATVARANJE IZMJENJIVAČA TOPLINE I POSTUPCI NJIHOVE UPOTREBE I UGRADNJE HEAT EXCHANGER CLOSURE ASSEMBLIES AND METHODS OF USING AND INSTALLING THE SAME</b>				
(73)	Lummus Technology LLC, 1515 Broad Street, Bloomfield, NJ 07003, US				
(72)	Richard Jibb, 64 Southfield Falls, Monroe, NY 10950, US Trevor Jaye, 1447 Chalcedony St., Apt A., San Diego, CA 92109, US Henk Boekhouder, Brechtzijde 41, 272 5NR Zoetermeer, NL Robert Groppi, 1515 Broad Street, Bloomfield, NJ 07003, US Vincenzo Marco Brignone, Langebrug 2A, 2311 TK Leiden, NL Randy Eberly, 5005 Saint Andrews Drive, Plainfield, IL 60586, US David Creech, 697 Saint Charles Road, Glen Ellyn, IL 60137, US Elizabeth Meacham, 267 North Garfield Street, Lombard, IL 60148, US				
(74)	Hraste & Partneri odvjetničko društvo d.o.o., Zagreb, HR				
(51)	MKP <b>F41A 9/69</b> (2006.01)	(10)		<a href="#">HR P20231590 T1</a>	
(11)	P20231590	(46)	15.03.2024.		
(21)	P20231590T	(22)	06.12.2023.		
(96)	<a href="#">EP 21000253.1</a>		13.12.2018.		
(97)	EP 3988889, 27.04.2022.		202217, De		
(97)	EP 3988889, 01.11.2023.		202344, De		
(31)	102018000740	(32)	30.01.2018.	(33)	DE
(62)	18859966.6 ; 13.12.2018.				
(54)	<b>KUČIŠTE OKVIRA ZA STRELJIVO ZA RUČNO VATRENO ORUŽJE I OKVIR ZA STRELJIVO ZA RUČNO VATRENO ORUŽJE HOUSING FOR A CARTRIDGE MAGAZINE FOR A HANDGUN AND CARTRIDGE MAGAZINE FOR A HANDGUN</b>				
(73)	Schmeisser GmbH, Adolf-Dembach-Str. 4, 47829 Krefeld, DE				
(72)	Andreas Schumacher, 47809 Krefeld, DE Thomas Hoff, 47807 Krefeld, DE				
(74)	Hraste & Partneri odvjetničko društvo d.o.o., Zagreb, HR				
(51)	MKP <b>F41J 11/00</b> (2009.01) <b>F41J 11/02</b> (2009.01)	(10)		<a href="#">HR P20231585 T1</a>	
(59)	MKP <b>F24F 110/65</b> (2018.01)	(10)		<a href="#">HR P20231593 T1</a>	
(11)	P20231585	(46)	15.03.2024.		
(21)	P20231585T	(22)	05.12.2023.		
(86)	PCT/NL2019050568		03.09.2019.		
(96)	<a href="#">EP 19787490.2</a>		03.09.2019.		
(87)	<a href="#">WO2020071903</a>		09.04.2020. , En		
(97)	EP 3861277, 11.08.2021.		202132, En		
(97)	EP 3861277, 01.11.2023.		202344, En		
(31)	2021750	(32)	03.10.2018.	(33)	NL
(54)	<b>ZATVORENA STRELJANA INDOOR SHOOTING RANGE</b>				
(73)	Ingenieursbureau en Technische Handelonderneming Autron B.V., Marconiweg 10, 8501 XM Joure, NL				
(72)	Jelle Moerland, c/o Ingenieursbureau en Technische Handelonderneming Autron B.V., Marconiweg 10, 8501 XM Joure, NL Arie Ponsen, c/o Ingenieursbureau en Technische Handelonderneming Autron B.V., Marconiweg 10, 8501 XM Joure, NL				
(74)	ZMP IP d.o.o., Zagreb, HR				
(51)	MKP <b>G01F 23/80</b> (2022.01) <b>G01F 23/284</b> (2006.01) <b>G01F 23/14</b> (2006.01) <b>G01F 23/24</b> (2006.01) <b>G01F 23/26</b> (2022.01)	(10)		<a href="#">HR P20231592 T1</a>	
(11)	P20231593	(46)	15.03.2024.		
(21)	P20231593T	(22)	06.12.2023.		
(96)	<a href="#">EP 18197579.8</a>		28.09.2018.		
(97)	EP 3628985, 01.04.2020.		202014, De		
(97)	EP 3628985, 13.09.2023.		202337, De		
(54)	<b>UREĐAJ ZA MJERENJE RAZINE PUNJENJA KORIŠTENJEM SENZORA RAZINE PUNJENJA KOJI KONTINUIRANO MJERI I POSTUPAK ZA RUKOVANJE TAKVIM UREĐAJEM ZA MJERENJE RAZINE PUNJENJA FILL LEVEL MEASURING DEVICE USING A CONTINUOUSLY MEASURING FILL LEVEL SENSOR AND METHOD FOR OPERATING SUCH A FILL LEVEL MEASURING DEVICE</b>				
(73)	VEGA Grieshaber KG, Hauptstr. 1 - 5, 77709 Wolfach, DE				
(72)	Jürgen Haas, Schulstraße 21, 77709 Oberwolfach, DE Jürgen Motzer, Bergach 17, 77723 Gengenbach, DE Karl Griebbaum, Hauptstraße 32, 77796 Mühlenbach, DE Jürgen Skowaisa, Ahornweg 6, 77761 Schiltach, DE				
(74)	ZMP IP d.o.o., Zagreb, HR				
(51)	MKP <b>G01N 33/68</b> (2006.01)	(10)		<a href="#">HR P20231592 T1</a>	
(11)	P20231592	(46)	15.03.2024.		
(21)	P20231592T	(22)	06.12.2023.		
(86)	PCT/GB2017051988		06.07.2017.		
(96)	<a href="#">EP 17742509.7</a>		06.07.2017.		
(87)	<a href="#">WO2018007817</a>		11.01.2018. , En		
(97)	EP 3482209, 15.05.2019.		201920, En		
(97)	EP 3482209, 15.11.2023.		202346, En		
(31)	201611840	(32)	07.07.2016.	(33)	GB
(54)	<b>ISPITIVANJE DETEKCIJE ALFA-SINUKLEINA I POSTUPAK DIJAGNOSTICIRANJA ALFA-SINUKLEINOPATIJE ALPHA-SYNUCLEIN DETECTION ASSAY AND METHOD FOR DIAGNOSING ALPHA-SYNUCLEINOPATHIES</b>				
(73)	The University Court Of The University of Edinburgh, Old College, South Bridge, EH8 9YL Edinburgh, Midlothian, GB				
(72)	Alison Green, c/o The University Court of the University of Edinburgh, Old College, South Bridge, EH8 9YL Edinburgh Midlothian, GB Graham Fairfoul, c/o The University Court of the University of Edinburgh, Old College, South Bridge, EH8 9YL Edinburgh Midlothian, GB				
(74)	ZMP IP d.o.o., Zagreb, HR				
(51)	MKP <b>G01P 3/487</b> (2006.01) <b>G01P 3/66</b> (2006.01)	(10)		<a href="#">HR P20231607 T1</a>	
(11)	P20231607	(46)	15.03.2024.		
(21)	P20231607T	(22)	07.12.2023.		
(96)	<a href="#">EP 20216895.1</a>		23.12.2020.		
(97)	EP 4019980, 29.06.2022.		202226, De		
(97)	EP 4019980, 04.10.2023.		202340, De		

- (54) **UREĐAJ ZA DOBIVANJE PODATAKA IZ KOJIH SE ODREĐUJE BRZINU VOZILA, NAPRAVA ZA PROCJENJIVANJE I ODGOVARAJUĆI POSTUPAK**  
DEVICE FOR DETECTING DATA FOR DETERMINING THE SPEED OF A VEHICLE, EVALUATION DEVICE AND METHOD THEREFOR
- (73) K.W.H. Ciclosport Vertriebs GmbH, Robert-Stirling-Ring 1, 82152 Krailling, DE
- (72) Georg Jahnen, 82166 Gräfelfing, DE  
Christian Becker, 82166 Gräfelfing, DE
- (74) Hraste & Partneri odvjetničko društvo d.o.o., Zagreb, HR

- (51) MKP (10) [HR P20231596 T1](#)  
**G01S 13/88** (2006.01)  
**G01S 7/03** (2006.01)  
**H05B 6/70** (2006.01)  
**H03B 1/04** (2006.01)  
**H03B 9/10** (2006.01)
- (11) P20231596 (46) 15.03.2024.  
(21) P20231596T (22) 06.12.2023.
- (86) PCT/US2019020260 01.03.2019.  
(96) [EP 19909625.6](#) 01.03.2019.  
(87) [WO2020180281.1](#), 10.09.2020.  
(97) EP 3732504, 04.11.2020. 202045, En  
(97) EP 3732504, 22.11.2023. 202347, En
- (54) **MIKROVALNI OSCILATOR I MIKROVALNI OSCILATOR MATRIČNOG TIPA UTEMELJEN NA NJEMU**  
MICROWAVE OSCILLATOR AND MATRIX-TYPE MICROWAVE OSCILLATOR BASED THEREON
- (73)(72) Mark Tarasov, ul. Sovetskaya, d. 4, kv. 4 Kirovskaya obl., 613137 d. Denisovy, Slobodskoy raion, RU
- (74) ZMP IP d.o.o., Zagreb, HR

- (51) MKP (10) [HR P20231656 T1](#)  
**G06F 21/57** (2013.01)  
**G06F 7/00** (2006.01)  
**B64C 39/02** (2023.01)  
**G05D 1/00** (2024.01)  
**H04L 67/125** (2022.01)  
**G06F 21/64** (2013.01)  
**G06F 21/44** (2013.01)  
**H04L 9/40** (2022.01)  
**H04W 12/10** (2021.01)
- (11) P20231656 (46) 15.03.2024.  
(21) P20231656T (22) 15.12.2023.
- (86) PCT/US2017036427 07.06.2017.  
(96) [EP 17783379.5](#) 07.06.2017.  
(87) [WO2017181204.1](#), 19.10.2017.  
(97) EP 3443451, 20.02.2019. 201908, En  
(97) EP 3443451, 20.09.2023. 202338, En  
(31) 201662322600 P (32) 14.04.2016. (33) US
- (54) **SUSTAV ZA PROVJERU CJELOVITOSTI BESPILOTNIH LETJELICA**  
SYSTEM FOR VERIFICATION OF INTEGRITY OF UNMANNED AERIAL VEHICLES
- (73) Rhombus Systems Group, Inc., 1760 Market Street, Suite 1100, Philadelphia, PA 19103, US
- (72) Erlend Olson, P.O. Box 10939, Newport Beach, CA 92658, US
- (74) Tomislav Hadžija, Zagreb, HR

- (51) MKP (10) [HR P20231552 T1](#)  
**G07D 11/12** (2019.01)  
**G07D 11/40** (2019.01)  
**B65H 31/10** (2006.01)  
**B65H 31/22** (2006.01)  
**B65H 31/26** (2006.01)
- (11) P20231552 (46) 15.03.2024.  
(21) P20231552T (22) 30.11.2023.
- (96) [EP 18000697.5](#) 27.08.2018.  
(97) EP 3447014, 27.02.2019. 201909, De  
(97) EP 3447014, 11.10.2023. 202341, De  
(31) 102017008014 (32) 25.08.2017. (33) DE
- (54) **UREĐAJ ZA PRIMANJE NOVČANICA**  
DEVICE FOR RECEIVING BANK NOTES
- (73) Double Power Europe GmbH, Hochheim Am Main, DE
- (72) Luitwin Peter Klostermann, Potsdam, DE  
Joachim Munck, Hochheim Am Main, DE
- (74) Sandra Russo Zelenović, Split, HR

- (51) MKP (10) [HR P20231577 T1](#)  
**G08B 21/04** (2006.01)
- (11) P20231577 (46) 15.03.2024.  
(21) P20231577T (22) 04.12.2023.
- (96) [EP 18211668.1](#) 11.12.2018.  
(97) EP 3667633, 17.06.2020. 202025, En  
(97) EP 3667633, 13.09.2023. 202337, En
- (54) **UREĐAJ I SUSTAV ZA NADZOR PACIJENATA**  
PATIENT MONITORING DEVICE AND ARRANGEMENT
- (73) E.ON Digital Technology GmbH, Tresckowstraße 5, 30457 Hannover, DE
- (72) Nicholas Ord, Humboldtstrasse 33, 30169 Hannover, DE
- (74) Tomislav Hadžija, Zagreb, HR

- (51) MKP (10) [HR P20231574 T1](#)  
**G10D 11/00** (2006.01)
- (11) P20231574 (46) 15.03.2024.  
(21) P20231574T (22) 04.12.2023.
- (96) [EP 21190420.6](#) 09.08.2021.  
(97) EP 4134945, 15.02.2023. 202307, De  
(97) EP 4134945, 27.09.2023. 202339, De
- (54) **SKLOP PLOČE S JEZIČCIMA, NAMIJENJEN GLAZBALU S RUČNIM RAZVLAČENJEM, SKLOP ZVUČNIH ŠTAPIĆA, NAMIJENJEN GLAZBALU S RUČNIM RAZVLAČENJEM KAO I GLAZBALO S RUČNIM RAZVLAČENJEM**  
REED PLATE ARRANGEMENT FOR A MANUAL PULLING INSTRUMENT, SOUND POST ARRANGEMENT FOR A MANUAL PULLING INSTRUMENT, AND MANUAL PULLING INSTRUMENT
- (73) Carboneon GmbH, Breitestrasse 5, 8400 Winterthur, CH
- (72) Srdjan Vukasinovic, 8400 Winterthur, CH  
Patrick Read, 3065 Bolligen, CH  
Christian Brauner, 5213 Villnachern, CH  
Jan Hess, 5600 Lenzburg, CH
- (74) Hraste & Partneri odvjetničko društvo d.o.o., Zagreb, HR

- (51) MKP (10) [HR P20231604 T1](#)  
**G16B 20/00** (2019.01)  
**G16B 20/10** (2019.01)
- (11) P20231604 (46) 15.03.2024.  
(21) P20231604T (22) 07.12.2023.
- (86) PCT/AU2014000012 09.01.2014.  
(96) [EP 14737956.4](#) 09.01.2014.  
(87) [WO2014107765.1](#), 17.07.2014.  
(97) EP 2943592, 18.11.2015. 201547, En  
(97) EP 2943592, 08.11.2023. 202345, En  
(31) 201361751213 P (32) 10.01.2013. (33) US  
201313837776 15.03.2013. US
- (54) **NEINVAZIVNO PRENATALNO MOLEKULSKO KARIOTIPIZIRANJE IZ MAJČINSKE PLAZME**  
NONINVASIVE PRENATAL MOLECULAR KARYOTYPING FROM MATERNAL PLASMA
- (73) The Chinese University Of Hong Kong, Office Of Research And Knowledge Transfer Services, Room 301, Pi Ch'iu Building, Shatin, New Territories, Hong Kong, CN
- (72) Wai Kwun Rossa Chiu, House 31, Double Haven, 52 Ma Lok Path, Shatin New Territories Hong Kong SAR, CN  
Yuk Ming Dennis Lo, 4th Floor, 7 King Tak Street, Homantin, Kowloon, Hong Kong, CN  
Kwan Chee Chan, Flat A, 13/F, Block 34, Broadway Street, Mei Foo Sun Chuen, Kowloon Hong Kong SAR, CN  
Peiyong Jiang, Flat 7, 1/F Block B, Kwong Lam Court, 62-66 Siu Lek Yuen Road, Shatin New Territories Hong Kong SAR, CN  
Cheuk Yin Jandy Yu, 20/F, Block5, Double Cove, 8 Wu Kai Sha Road, Ma On Shan, New Territories Hong Kong SAR, CN
- (74) Hraste & Partneri odvjetničko društvo d.o.o., Zagreb, HR

- (51) MKP (10) [HR P20231741 T1](#)  
**H01L 31/0224** (2006.01)  
**H01L 31/0747** (2012.01)
- (11) P20231741 (46) 15.03.2024.  
(21) P20231741T (22) 28.12.2023.
- (86) PCT/EP2021078719 15.10.2021.  
(96) [EP 21793934.7](#) 15.10.2021.  
(87) [WO2022084205.1](#), 28.04.2022.  
(97) EP 4078683, 26.10.2022. 202243, En

(97)	EP 4078683, 06.12.2023.	202349, En			
(31)	20203399	(32) 22.10.2020.	(33) EP		
(54)	<b>FOTONAPONSKI UREDAJ I POSTUPAK NJEGOVE PROIZVODNJE</b>				
	PHOTOVOLTAIC DEVICE AND METHOD FOR MANUFACTURING THE SAME				
(73)	Meyer Burger (Germany) GmbH, An der Baumschule 6-8, 09337 Hohenstein-Ernstthal, DE				
(72)	Damien Lachenal, 2016 Cortaillod, CH Pierre Papet, 2068 Hauterive, CH Till Kössler, 1110 Morges, CH				
(74)	ZMP IP d.o.o., Zagreb, HR				
<hr/>					
(51)	MKP	(10)	<a href="#">HR P20231623 T1</a>		
	<b>H04L 65/611</b> (2022.01)				
	<b>H04L 65/612</b> (2022.01)				
	<b>H04L 65/10</b> (2022.01)				
	<b>H04N 21/6405</b> (2011.01)				
	<b>H04N 21/6408</b> (2011.01)				
(11)	P20231623	(46)	15.03.2024.		
(21)	P20231623T	(22)	11.12.2023.		
(86)	PCT/IB2018001488 28.11.2018.				
(96)	<a href="#">EP 18836386.5</a> 28.11.2018.				
(87)	<a href="#">WO2020109834</a> , 04.06.2020.				
(97)	EP 3888316, 06.10.2021. 202140, En				
(97)	EP 3888316, 13.09.2023. 202337, En				
(54)	<b>POSTUPAK I SUSTAV ZA ISPORUKU AUDIO-VIZUALNIH SADRŽAJA UŽIVO</b>				
	METHOD AND SYSTEM FOR AUDIO-VISUAL LIVE CONTENT DELIVERY				
(73)	Broadpeak, 15 Rue Claude Chappe, Zone des Champs Blancs, 35510 Cesson Sevigne, FR				
(72)	Sophie Bâlé, c/o Broadpeak, 15 rue Claude Chappe, Zone des Champs Blancs, 35510 Cesson Sévigné, FR Rémy Brebion, c/o Broadpeak, 15 rue Claude Chappe, Zone des Champs Blancs, 35510 Cesson Sévigné, FR Nicolas Renard, c/o Broadpeak, 15 rue Claude Chappe, Zone des Champs Blancs, 35510 Cesson Sévigné, FR Jean-François Martin, c/o Broadpeak, 15 rue Claude Chappe, Zone des Champs Blancs, 35510 Cesson Sévigné, FR Pierre-Olivier Bouteau, c/o Broadpeak, 15 rue Claude Chappe, Zone des Champs Blancs, 35510 Cesson Sévigné, FR				
(74)	Tomislav Hadžija, Zagreb, HR				
<hr/>					
(51)	MKP	(10)	<a href="#">HR P20231610 T1</a>		
	<b>H04L 65/70</b> (2022.01)				
	<b>H04N 21/854</b> (2011.01)				
	<b>H04L 65/612</b> (2022.01)				
(11)	P20231610	(46)	15.03.2024.		
(21)	P20231610T	(22)	10.12.2023.		
(96)	<a href="#">EP 21199543.6</a> 28.11.2013.				
(97)	EP 3955581, 16.02.2022. 202207, En				
(97)	EP 3955581, 18.10.2023. 202342, En				
(31)	201261731360 P	(32) 29.11.2012.	(33) US		
	201314091243	26.11.2023.	US		
(62)	13858997.3 ; 28.11.2013.				
(54)	<b>POSTUPAK ZA PRIJENOS I PRIJAM MEDIJSKIH PODATAKA</b>				
	METHODS FOR TRANSMITTING OR RECEIVING MEDIA DATA				
(73)	Samsung Electronics Co., Ltd., 129, Samsung-ro, Yeongtong-gu, Gyeonggi-do, 16677 Suwon-si, KR				
(72)	Imed Bouazizi, 16677 Suwon-si, KR Young-Kwon Lim, 16677 Suwon-si, KR Kong Posh Bhat, 16677 Suwon-si, KR				
(74)	KORPER I PARTNERI odvjetničko društvo d.o.o., Zagreb, HR				
<hr/>					
(51)	MKP	(10)	<a href="#">HR P20231695 T1</a>		
	<b>H04N 19/105</b> (2014.01)				
	<b>H04N 19/513</b> (2014.01)				
	<b>H04N 19/132</b> (2014.01)				
	<b>H04N 19/176</b> (2014.01)				
	<b>H04N 19/70</b> (2014.01)				
	<b>H04N 19/174</b> (2014.01)				
(11)	P20231695	(46)	15.03.2024.		
(21)	P20231695T	(22)	21.12.2023.		
(86)	PCT/KR2019012991 04.10.2019.				
(96)	<a href="#">EP 19869170.1</a> 04.10.2019.				
(87)	<a href="#">WO2020071829</a> , 09.04.2020. , Ko				
(97)	EP 3846467, 07.07.2021. 202127, En				
<hr/>					
(51)	MKP	(10)	<a href="#">HR P20231634 T1</a>		
	<b>H04N 19/159</b> (2014.01)				
	<b>H04N 19/18</b> (2014.01)				
	<b>H04N 19/132</b> (2014.01)				
	<b>H04N 19/12</b> (2014.01)				
(11)	P20231634	(46)	15.03.2024.		
(21)	P20231634T	(22)	12.12.2023.		
(86)	PCT/KR2020005076 16.04.2020.				
(96)	<a href="#">EP 20792204.8</a> 16.04.2020.				
(87)	<a href="#">WO2020213944</a> , 22.10.2020. , Ko				
(97)	EP 3944618, 26.01.2022. 202204, En				
(97)	EP 3944618, 06.12.2023. 202349, En				
(31)	201962834946 P	(32) 16.04.2019.	(33) US		
(54)	<b>TRANSFORMACIJA NAMIJENJENA UNUTARNJEM PREDVIĐANJU NA TEMELJU MATRICE PRILIKOM KODIRANJA SLIKE</b>				
	TRANSFORM FOR MATRIX-BASED INTRA-PREDICTION IN IMAGE CODING				
(73)	LG Electronics Inc., 128, Yeoui-daero, Yeongdeungpo-gu, 07336 Seoul, KR				
(72)	Junghak Nam, IP Center, LG Electronics Inc., 19, Yangjae-daero, 11-gil Seocho-gu, 06772 Seoul, KR Jaehyun Lim, IP Center, LG Electronics Inc., 19, Yangjae-daero, 11-gil Seocho-gu, 06772 Seoul, KR Moonmo Koo, IP Center, LG Electronics Inc., 19, Yangjae-daero, 11-gil Seocho-gu, 06772 Seoul, KR Seunghwan Kim, IP Center, LG Electronics Inc., 19, Yangjae-daero, 11-gil Seocho-gu, 06772 Seoul, KR				
(74)	Hraste & Partneri odvjetničko društvo d.o.o., Zagreb, HR				
<hr/>					
(51)	MKP	(10)	<a href="#">HR P20231736 T1</a>		
	<b>H04N 19/196</b> (2014.01)				
	<b>H04N 19/46</b> (2014.01)				
	<b>H04N 19/436</b> (2014.01)				
	<b>H04N 19/91</b> (2014.01)				
(11)	P20231736	(46)	15.03.2024.		
(21)	P20231736T	(22)	28.12.2023.		
(96)	<a href="#">EP 20205782.4</a> 05.11.2012.				
(97)	EP 3806464, 14.04.2021. 202115, En				
(97)	EP 3806464, 18.10.2023. 202342, En				
(31)	2011243940	(32) 07.11.2011.	(33) JP		
(62)	12801780.3 ; 05.11.2012.				
(54)	<b>UREDAJ ZA KODIRANJE SLIKE, POSTUPAK KODIRANJA SLIKE, UREDAJ ZA DEKODIRANJE SLIKE, POSTUPAK DEKODIRANJA SLIKE I PROGRAM</b>				
	IMAGE CODING APPARATUS, IMAGE CODING METHOD, IMAGE DECODING APPARATUS, IMAGE DECODING METHOD, AND PROGRAM				
(73)	CANON KABUSHIKI KAISHA, 30-2, Shimomaruko 3-chome, Ohta-ku, 146-8501 Tokyo, JP				
(72)	Koji Okawa, c/o CANON KABUSHIKI KAISHA, 30-2, Shimomaruko 3-chome, 146-8501 Ohta-ku, Tokyo, JP				
(74)	ZMP IP d.o.o., Zagreb, HR				
<hr/>					
(51)	MKP	(10)	<a href="#">HR P20231737 T1</a>		
	<b>H04N 19/196</b> (2014.01)				
	<b>H04N 19/46</b> (2014.01)				
	<b>H04N 19/436</b> (2014.01)				
	<b>H04N 19/91</b> (2014.01)				
(11)	P20231737	(46)	15.03.2024.		

(21)	P20231737T	(22)	28.12.2023.	(62)	11829495.8 ; 02.09.2011.
(96)	<a href="#">EP 20205785.7</a>		05.11.2012.	(54)	<b>POSTUPAK ZA DIJELJENJE BLOKA I UREĐAJ ZA DEKODIRANJE</b>
(97)	EP 3806465, 14.04.2021.		202115, En		<b>METHOD FOR PARTITIONING BLOCK AND DECODING DEVICE</b>
(97)	EP 3806465, 18.10.2023.		202342, En	(73)	LG Electronics, Inc., 20, Yeouido-dong, Yeongdeungpo-gu, 150-721 Seoul, KR
(31)	2011243940	(32)	07.11.2011.	(33)	JP
(62)	12801780.3 ; 05.11.2012.			(72)	Jungsun Kim, 137-130 Seoul, KR Seungwook Park, 137-130 Seoul, KR Jaewon Sung, 137-130 Seoul, KR Joonyoung Park, 137-130 Seoul, KR Byeongmoon Jeon, 137-130 Seoul, KR Jaehyun Lim, 137-130 Seoul, KR Yongjoon Jeon, 137-130 Seoul, KR Younghee Choi, 137-130 Seoul, KR
(54)	<b>UREĐAJ ZA KODIRANJE SLIKE, POSTUPAK KODIRANJA SLIKE, UREĐAJ ZA DEKODIRANJE SLIKE, POSTUPAK DEKODIRANJA SLIKE I PROGRAM</b>			(74)	ZMP IP d.o.o., Zagreb, HR
	IMAGE CODING APPARATUS, IMAGE CODING METHOD, IMAGE DECODING APPARATUS, IMAGE DECODING METHOD, AND PROGRAM				
(73)	CANON KABUSHIKI KAISHA, 30-2, Shimomaruko 3-chome, Ohta-ku, 146-8501 Tokyo, JP				
(72)	Koji Okawa, c/o CANON KABUSHIKI KAISHA, 30-2, Shimomaruko 3-chome, 146-8501 Ohta-ku, Tokyo, JP				
(74)	ZMP IP d.o.o., Zagreb, HR				

(51)	MKP	(10)	<a href="#">HR P20231726 T1</a>		
	<b>H04N 19/43</b> (2014.01)				
(11)	P20231726	(46)	15.03.2024.		
(21)	P20231726T	(22)	27.12.2023.		
(96)	<a href="#">EP 20205750.1</a>		16.08.2012.		
(97)	EP 3806469, 14.04.2021.		202115, En		
(97)	EP 3806469, 11.10.2023.		202341, En		
(31)	201114184	(32)	17.08.2011.	(33)	GB
(62)	12751267.1 ; 16.08.2012.				
(54)	<b>POSTUPAK I UREĐAJ ZA KODIRANJE SEKVENCE SLIKA I POSTUPAK I UREĐAJ ZA DEKODIRANJE SEKVENCE SLIKA</b>				
	METHOD AND DEVICE FOR ENCODING A SEQUENCE OF IMAGES AND METHOD AND DEVICE FOR DECODING A SEQUENCE OF IMAGES				
(73)	CANON KABUSHIKI KAISHA, 30-2, Shimomaruko 3-chome, Ohta-ku, 146-8501 Tokyo, JP				
(72)	Guillaume Laroche, 5 La Basse Romerai, 35250 Saint Aubin d'Aubigné, FR				
(74)	ZMP IP d.o.o., Zagreb, HR				

(51)	MKP	(10)	<a href="#">HR P20231669 T1</a>		
	<b>H04N 19/52</b> (2014.01)				
(11)	P20231669	(46)	15.03.2024.		
(21)	P20231669T	(22)	18.12.2023.		
(96)	<a href="#">EP 21175983.2</a>		02.09.2011.		
(97)	EP 3907999, 10.11.2021.		202145, En		
(97)	EP 3907999, 22.11.2023.		202347, En		
(31)	37970810 P	(32)	02.09.2010.	(33)	US
	41093910 P		08.11.2010.		US
	41280510 P		12.11.2010.		US
(62)	11822168.8 ; 02.09.2011.				
(54)	<b>INTER PREDIKCIJA</b>				
	INTER PREDICTION				
(73)	LG Electronics, Inc., 20, Yeouido-dong, Yeongdeungpo-gu, 150-721 Seoul, KR				
(72)	Jaehyun Lim, 137-130 Seoul, KR Jungsun Kim, 137-130 Seoul, KR Seungwook Park, 137-130 Seoul, KR Jaewon Sung, 137-130 Seoul, KR Byeongmoon Jeon, 137-130 Seoul, KR Joonyoung Park, 137-130 Seoul, KR Yongjoon Jeon, 137-130 Seoul, KR Younghee Choi, 137-130 Seoul, KR				
(74)	ZMP IP d.o.o., Zagreb, HR				

(51)	MKP	(10)	<a href="#">HR P20231580 T1</a>		
	<b>H04N 19/70</b> (2014.01)				
	<b>H04N 19/593</b> (2014.01)				
(11)	P20231580	(46)	15.03.2024.		
(21)	P20231580T	(22)	05.12.2023.		
(96)	<a href="#">EP 22180460.2</a>		02.09.2011.		
(97)	EP 4084478, 02.11.2022.		202244, En		
(97)	EP 4084478, 01.11.2023.		202344, En		
(31)	38657910 P	(32)	27.09.2010.	(33)	US
	38859210 P		30.09.2010.		US
	38861210 P		01.10.2010.		US
	40563510 P		21.10.2010.		US
	40563810 P		21.10.2010.		US
	42360210 P		16.12.2010.		US

(51)	MKP	(10)	<a href="#">HR P20231559 T1</a>		
	<b>H04N 23/617</b> (2023.01)				
	<b>H04N 23/63</b> (2023.01)				
(11)	P20231559	(46)	15.03.2024.		
(21)	P20231559T	(22)	01.12.2023.		
(86)	PCT/AU2015050660		26.10.2015.		
(96)	<a href="#">EP 15853005.5</a>		26.10.2015.		
(87)	<a href="#">WO2016061634</a>		28.04.2016.		
(97)	EP 3210371, 30.08.2017.		201735, En		
(97)	EP 3210371, 13.09.2023.		202337, En		
(31)	2014904256	(32)	24.10.2014.	(33)	AU
(54)	<b>APLIKACIJA ZA KAMERU</b>				
	CAMERA APPLICATION				
(73)	Beezbutt PTY Limited, Level 1, 56 Clarence Street, 2000 Sydney, NSW, AU				
(72)	Paul Wright, c/o Beezbutt Pty Limited, 307/3 Gladstone Street, 2042 Newtown, NSW, AU Catherine Montoya, 2/6 Oxford Street, 2111 Gladesville, NSW, AU May Hnin Phyu, 1 Bennett Road, 2142 South Granville, NSW, AU Erick Haryono, 1/9 McKern Street, 2194 Campsie, NSW, AU Jeong Kwang Nam, U37 46-50 John Street, 2141 Lidcombe, NSW, AU				
	Charbel Anthony Zeaiter, c/o Velvet Onion Pty Ltd, 807/46-56 Kippax Street, 2010 Surry Hills, NSW, AU				
(74)	PRODUCTA d.o.o., Zagreb, HR				

## Kazalo brojeva europskih patenata

Broj patenta (11)	MKP (51)	Broj patenta (11)	MKP (51)	Broj patenta (11)	MKP (51)
P20231163	<b>A61K 31/404</b> (2006.01) <b>A61K 31/66</b> (2006.01) <b>A61K 31/7076</b> (2006.01) <b>A61P 35/00</b> (2006.01) <b>C07C 227/14</b> (2006.01) <b>C07D 209/10</b> (2006.01) <b>C07D 317/40</b> (2006.01) <b>C07F 9/06</b> (2006.01)	P20231551	<b>B65D 85/804</b> (2006.01) <b>A47J 31/02</b> (2006.01)	P20231573	<b>B65D 5/20</b> (2006.01) <b>B65D 5/24</b> (2006.01) <b>B65D 5/68</b> (2006.01)
P20231340	<b>F28D 20/00</b> (2006.01)	P20231552	<b>G07D 11/12</b> (2019.01) <b>G07D 11/40</b> (2019.01) <b>B65H 31/10</b> (2006.01) <b>B65H 31/22</b> (2006.01) <b>B65H 31/26</b> (2006.01)	P20231574	<b>G10D 11/00</b> (2006.01)
P20231525	<b>A61P 35/00</b> (2006.01) <b>A61P 35/04</b> (2006.01) <b>A61P 37/04</b> (2006.01) <b>C12N 15/113</b> (2010.01) <b>A61K 31/7088</b> (2006.01)	P20231554	<b>C04B 28/00</b> (2006.01) <b>C04B 28/02</b> (2006.01) <b>C04B 28/08</b> (2006.01) <b>C04B 28/12</b> (2006.01) <b>C04B 28/14</b> (2006.01) <b>C04B 28/26</b> (2006.01) <b>B28B 1/00</b> (2006.01) <b>B28B 13/02</b> (2006.01)	P20231575	<b>A61M 5/20</b> (2006.01) <b>A61M 5/28</b> (2006.01)
P20231530	<b>E04F 17/02</b> (2006.01) <b>E04F 17/04</b> (2006.01) <b>E04F 19/00</b> (2006.01)	P20231559	<b>H04N 23/617</b> (2023.01) <b>H04N 23/63</b> (2023.01)	P20231576	<b>A61K 31/221</b> (2006.01) <b>A61K 31/222</b> (2006.01) <b>A61K 31/223</b> (2006.01) <b>A61K 31/225</b> (2006.01) <b>A61K 31/255</b> (2006.01) <b>A61P 25/28</b> (2006.01) <b>G01N 33/50</b> (2006.01) <b>G01N 33/52</b> (2006.01)
P20231536	<b>C07K 7/00</b> (2006.01) <b>C07K 14/00</b> (2006.01) <b>C07K 16/00</b> (2006.01) <b>C07K 17/00</b> (2006.01) <b>C07H 21/00</b> (2006.01) <b>G01N 33/543</b> (2006.01) <b>C40B 70/00</b> (2006.01) <b>B82Y 5/00</b> (2011.01)	P20231560	<b>F01N 13/04</b> (2010.01) <b>F01N 13/08</b> (2010.01) <b>F01N 1/16</b> (2006.01) <b>F01N 1/18</b> (2006.01) <b>F16K 1/00</b> (2006.01) <b>F16K 11/08</b> (2006.01)	P20231577	<b>G08B 21/04</b> (2006.01)
P20231537	<b>C07D 417/14</b> (2006.01) <b>C07D 401/14</b> (2006.01) <b>C07D 403/14</b> (2006.01) <b>A61K 31/4725</b> (2006.01) <b>A61P 15/00</b> (2006.01)	P20231563	<b>C07D 495/04</b> (2006.01) <b>A61K 31/5025</b> (2006.01) <b>A61P 9/10</b> (2006.01) <b>A61P 17/00</b> (2006.01) <b>A61P 13/12</b> (2006.01) <b>A61Q 19/08</b> (2006.01)	P20231578	<b>C07K 16/28</b> (2006.01) <b>A61K 39/395</b> (2006.01) <b>A61K 39/00</b> (2006.01)
P20231538	<b>C07D 243/24</b> (2006.01) <b>A61K 31/5513</b> (2006.01) <b>A61P 25/02</b> (2006.01)	P20231567	<b>C07K 14/72</b> (2006.01) <b>A61K 38/08</b> (2019.01) <b>A61K 38/10</b> (2006.01) <b>C07K 7/06</b> (2006.01) <b>C07K 7/08</b> (2006.01)	P20231579	<b>C07K 16/28</b> (2006.01) <b>A61K 39/00</b> (2006.01) <b>A61P 11/00</b> (2006.01) <b>A61P 35/04</b> (2006.01)
P20231542	<b>C07K 19/00</b> (2006.01) <b>C12N 5/10</b> (2006.01) <b>A61K 39/395</b> (2006.01) <b>A61P 35/00</b> (2006.01) <b>A61P 35/02</b> (2006.01) <b>C07K 14/725</b> (2006.01) <b>C07K 14/705</b> (2006.01) <b>C07K 16/28</b> (2006.01) <b>C07K 16/30</b> (2006.01) <b>C12N 15/62</b> (2006.01) <b>A61P 7/00</b> (2006.01) <b>C07K 14/435</b> (2006.01)	P20231568	<b>A61K 31/4545</b> (2006.01) <b>C07D 401/12</b> (2006.01) <b>A61P 3/00</b> (2006.01) <b>A61P 3/10</b> (2006.01) <b>A61P 25/16</b> (2006.01) <b>A61P 25/08</b> (2006.01) <b>A61P 25/32</b> (2006.01) <b>A61P 25/24</b> (2006.01) <b>A61P 25/00</b> (2006.01) <b>A61P 43/00</b> (2006.01)	P20231580	<b>H04N 19/70</b> (2014.01) <b>H04N 19/593</b> (2014.01)
P20231544	<b>C07K 1/113</b> (2006.01) <b>C07K 1/34</b> (2006.01) <b>B01D 15/36</b> (2006.01) <b>B01D 15/38</b> (2006.01)	P20231569	<b>A61K 39/00</b> (2006.01) <b>A61K 39/395</b> (2006.01) <b>A61P 35/00</b> (2006.01) <b>G01N 33/53</b> (2006.01) <b>C07K 16/24</b> (2006.01)	P20231581	<b>A61K 39/12</b> (2006.01)
P20231545	<b>B23H 9/10</b> (2006.01) <b>B23H 3/04</b> (2006.01) <b>B23H 11/00</b> (2006.01)	P20231570	<b>A61K 39/00</b> (2006.01) <b>C07K 16/28</b> (2006.01) <b>A61P 35/00</b> (2006.01) <b>C07K 14/47</b> (2006.01)	P20231582	<b>C07J 63/00</b> (2006.01) <b>A61K 31/58</b> (2006.01) <b>A61P 31/18</b> (2006.01) <b>A61K 31/18</b> (2006.01)
P20231547	<b>C07D 403/12</b> (2006.01) <b>C07D 401/14</b> (2006.01) <b>C07D 405/14</b> (2006.01) <b>C07D 413/14</b> (2006.01) <b>A61K 31/4418</b> (2006.01) <b>A61K 31/505</b> (2006.01) <b>A61K 31/506</b> (2006.01) <b>A61K 31/513</b> (2006.01) <b>A61K 31/5377</b> (2006.01) <b>A61K 31/55</b> (2006.01) <b>C07D 401/04</b> (2006.01) <b>C07D 403/14</b> (2006.01) <b>C07D 413/12</b> (2006.01) <b>C07D 495/04</b> (2006.01) <b>A61P 25/28</b> (2006.01)	P202315759	<b>A61K 39/00</b> (2006.01) <b>C07K 16/28</b> (2006.01) <b>A61P 35/00</b> (2006.01) <b>C07K 14/47</b> (2006.01)	P20231584	<b>A61K 31/04</b> (2006.01) <b>A61K 31/202</b> (2006.01) <b>A61K 31/375</b> (2006.01) <b>A61K 31/7068</b> (2006.01) <b>A61K 31/7072</b> (2006.01) <b>A61P 25/28</b> (2006.01) <b>A61P 3/02</b> (2006.01)
P20231548	<b>A61K 9/16</b> (2006.01) <b>A61K 9/20</b> (2006.01) <b>A61K 9/48</b> (2006.01) <b>A61K 31/506</b> (2006.01) <b>A61P 35/00</b> (2006.01)	P20231571	<b>C07D 239/16</b> (2006.01) <b>C07D 239/12</b> (2006.01) <b>C07D 401/12</b> (2006.01) <b>C07D 403/12</b> (2006.01) <b>C07D 405/12</b> (2006.01) <b>C07D 413/12</b> (2006.01) <b>A61K 31/505</b> (2006.01) <b>A61P 31/14</b> (2006.01)	P20231585	<b>F41J 11/00</b> (2009.01) <b>F41J 11/02</b> (2009.01) <b>F24F 110/65</b> (2018.01)
		P20231572	<b>A61K 31/198</b> (2006.01) <b>A61K 31/205</b> (2006.01) <b>A61K 45/06</b> (2006.01) <b>A61K 31/277</b> (2006.01) <b>A61P 3/02</b> (2006.01) <b>A61P 3/04</b> (2006.01) <b>A61P 3/06</b> (2006.01) <b>A61P 3/08</b> (2006.01) <b>A61P 3/10</b> (2006.01)	P20231586	<b>A61K 31/444</b> (2006.01) <b>A61P 25/06</b> (2006.01) <b>A61K 31/47</b> (2006.01) <b>A61P 31/18</b> (2006.01) <b>C07D 215/56</b> (2006.01)
				P20231587	<b>B64D 11/02</b> (2006.01) <b>E06B 3/36</b> (2006.01) <b>E04H 1/12</b> (2006.01)
				P20231590	<b>F41A 9/69</b> (2006.01)
				P20231591	<b>A61K 47/26</b> (2006.01) <b>A61K 9/107</b> (2006.01) <b>A61K 31/12</b> (2006.01) <b>A61P 3/06</b> (2006.01) <b>A61P 3/04</b> (2006.01) <b>A61P 3/10</b> (2006.01) <b>A61K 31/352</b> (2006.01) <b>A61K 36/185</b> (2006.01) <b>A61K 36/9066</b> (2006.01) <b>A61P 1/16</b> (2006.01) <b>A61K 36/484</b> (2006.01)
				P20231592	<b>G01N 33/68</b> (2006.01)
				P20231593	<b>G01F 23/80</b> (2022.01) <b>G01F 23/284</b> (2006.01) <b>G01F 23/14</b> (2006.01) <b>G01F 23/24</b> (2006.01) <b>G01F 23/26</b> (2022.01)
				P20231594	<b>A01K 67/033</b> (2006.01) <b>G05D 23/00</b> (2006.01)

Broj patenta (11)	MKP (51)	Broj patenta (11)	MKP (51)	Broj patenta (11)	MKP (51)
P20231595	<b>A01K 67/033</b> (2006.01) <b>G05D 23/00</b> (2006.01)	P20231616	<b>C07D 223/16</b> (2006.01) <b>C07D 401/14</b> (2006.01) <b>C07D 401/06</b> (2006.01) <b>C07D 401/10</b> (2006.01) <b>C07D 403/06</b> (2006.01) <b>C07D 405/12</b> (2006.01) <b>C07D 409/12</b> (2006.01) <b>A61P 13/12</b> (2006.01) <b>A61K 31/55</b> (2006.01)	P20231641	<b>A61K 31/03</b> (2006.01) <b>A61K 9/107</b> (2006.01) <b>A61K 9/16</b> (2006.01) <b>A61P 35/00</b> (2006.01) <b>A61K 9/14</b> (2006.01)
P20231596	<b>G01S 13/88</b> (2006.01) <b>G01S 7/03</b> (2006.01) <b>H05B 6/70</b> (2006.01) <b>H03B 1/04</b> (2006.01) <b>H03B 9/10</b> (2006.01)	P20231618	<b>C07D 401/12</b> (2006.01) <b>C07D 401/14</b> (2006.01)	P20231642	<b>A61K 47/32</b> (2006.01) <b>A61P 35/00</b> (2006.01) <b>C08F 222/10</b> (2006.01)
P20231597	<b>F23D 14/32</b> (2006.01) <b>F23N 1/02</b> (2006.01) <b>F24D 3/00</b> (2022.01) <b>F23L 7/00</b> (2006.01) <b>F24D 18/00</b> (2022.01)	P20231621	<b>A61K 38/13</b> (2006.01) <b>A61P 37/06</b> (2006.01) <b>A61K 9/00</b> (2006.01) <b>A61K 47/26</b> (2006.01) <b>A61K 9/127</b> (2006.01) <b>A61K 9/19</b> (2006.01)	P20231644	<b>A61K 31/721</b> (2006.01)
P20231600	<b>B32B 7/12</b> (2006.01) <b>B32B 15/082</b> (2006.01) <b>B32B 15/095</b> (2006.01) <b>B32B 15/098</b> (2006.01) <b>B32B 15/10</b> (2006.01) <b>B32B 15/20</b> (2006.01) <b>B32B 21/08</b> (2006.01) <b>B32B 21/10</b> (2006.01) <b>B32B 21/14</b> (2006.01) <b>B32B 3/12</b> (2006.01) <b>B32B 17/06</b> (2006.01) <b>B32B 38/08</b> (2006.01) <b>B32B 37/12</b> (2006.01)	P20231622	<b>F16B 12/16</b> (2006.01) <b>F16B 5/06</b> (2006.01) <b>F16B 5/02</b> (2006.01) <b>F16B 3/00</b> (2006.01)	P20231645	<b>C07K 14/725</b> (2006.01)
P20231601	<b>F23M 7/00</b> (2006.01)	P20231623	<b>H04L 65/611</b> (2022.01) <b>H04L 65/612</b> (2022.01) <b>H04L 65/10</b> (2022.01) <b>H04N 21/6405</b> (2011.01) <b>H04N 21/6408</b> (2011.01)	P20231646	<b>A45D 24/30</b> (2006.01)
P20231603	<b>B63B 15/00</b> (2006.01)	P20231624	<b>F16K 1/02</b> (2006.01) <b>F17C 1/00</b> (2006.01) <b>B01F 23/00</b> (2022.01)	P20231647	<b>A41D 19/00</b> (2006.01) <b>A41D 19/015</b> (2006.01) <b>A41D 19/02</b> (2006.01) <b>B29D 99/00</b> (2010.01)
P20231604	<b>G16B 20/00</b> (2019.01) <b>G16B 20/10</b> (2019.01)	P20231625	<b>B02C 18/14</b> (2006.01) <b>B02C 18/18</b> (2006.01) <b>B02C 18/20</b> (2006.01) <b>B23D 61/02</b> (2006.01)	P20231648	<b>A23L 7/109</b> (2016.01) <b>A23P 30/20</b> (2016.01)
P20231605	<b>A24F 40/48</b> (2020.01) <b>A24F 40/485</b> (2020.01) <b>A24F 40/10</b> (2020.01) <b>A61M 15/00</b> (2006.01) <b>A61M 15/06</b> (2006.01) <b>A61M 11/04</b> (2006.01) <b>G01F 11/02</b> (2006.01) <b>G16H 20/13</b> (2018.01)	P20231626	<b>F28F 9/02</b> (2006.01) <b>F28F 27/00</b> (2006.01) <b>F16J 15/02</b> (2006.01) <b>F28D 7/16</b> (2006.01)	P20231649	<b>A23C 19/028</b> (2006.01) <b>A23C 19/076</b> (2006.01) <b>A23C 19/02</b> (2006.01) <b>A23C 19/05</b> (2006.01) <b>A23C 9/142</b> (2006.01)
P20231606	<b>C12N 15/113</b> (2010.01)	P20231627	<b>F16L 55/17</b> (2006.01) <b>F16L 55/172</b> (2006.01) <b>F16J 15/06</b> (2006.01)	P20231651	<b>B65B 7/28</b> (2006.01) <b>B65B 7/16</b> (2006.01) <b>B65B 47/00</b> (2006.01) <b>B65B 51/02</b> (2006.01) <b>B65B 55/24</b> (2006.01) <b>B65B 57/06</b> (2006.01) <b>B65B 61/00</b> (2006.01) <b>B65D 77/20</b> (2006.01)
P20231607	<b>G01P 3/487</b> (2006.01) <b>G01P 3/66</b> (2006.01)	P20231629	<b>A61K 8/37</b> (2006.01) <b>A61K 8/49</b> (2006.01) <b>A61K 8/64</b> (2006.01) <b>A61P 17/14</b> (2006.01) <b>A61Q 7/00</b> (2006.01)	P20231653	<b>A61K 9/08</b> (2006.01) <b>A61K 31/4045</b> (2006.01) <b>A61P 1/00</b> (2006.01)
P20231608	<b>A61P 1/16</b> (2006.01) <b>A61P 9/00</b> (2006.01) <b>A61P 11/00</b> (2006.01) <b>A61P 13/12</b> (2006.01) <b>A61P 27/00</b> (2006.01) <b>A61P 35/00</b> (2006.01) <b>C07D 405/14</b> (2006.01) <b>C07D 213/71</b> (2006.01) <b>C07D 401/12</b> (2006.01) <b>C07D 401/14</b> (2006.01) <b>A61K 31/454</b> (2006.01) <b>A61K 31/4545</b> (2006.01) <b>A61K 31/5377</b> (2006.01) <b>A61K 45/06</b> (2006.01)	P20231630	<b>A61K 39/12</b> (2006.01) <b>A61K 39/00</b> (2006.01) <b>A61K 39/23</b> (2006.01) <b>A61K 39/135</b> (2006.01) <b>A61P 31/00</b> (2006.01) <b>A61P 31/20</b> (2006.01)	P20231654	<b>C07D 471/18</b> (2006.01) <b>A61P 31/18</b> (2006.01)
P20231609	<b>C07K 16/28</b> (2006.01) <b>C07K 16/30</b> (2006.01) <b>A61K 47/68</b> (2017.01) <b>A61P 35/00</b> (2006.01) <b>A61K 31/40</b> (2006.01)	P20231631	<b>C07K 14/33</b> (2006.01) <b>A61K 39/08</b> (2006.01) <b>C07K 16/12</b> (2006.01)	P20231656	<b>G06F 21/57</b> (2013.01) <b>G06F 7/00</b> (2006.01) <b>B64C 39/02</b> (2023.01) <b>G05D 1/00</b> (2024.01) <b>H04L 67/125</b> (2022.01) <b>G06F 21/64</b> (2013.01) <b>G06F 21/44</b> (2013.01) <b>H04L 9/40</b> (2022.01) <b>H04W 12/10</b> (2021.01)
P20231610	<b>H04L 65/70</b> (2022.01) <b>H04N 21/854</b> (2011.01) <b>H04L 65/612</b> (2022.01)	P20231632	<b>A61F 2/12</b> (2006.01) <b>A61F 2/00</b> (2006.01)	P20231658	<b>B05B 16/20</b> (2018.01) <b>B05B 16/00</b> (2018.01)
P20231613	<b>A61K 31/609</b> (2006.01) <b>A61K 38/26</b> (2006.01) <b>A61K 9/20</b> (2006.01) <b>A61P 3/00</b> (2006.01) <b>A61P 3/04</b> (2006.01) <b>A61P 3/10</b> (2006.01)	P20231633	<b>A01N 25/28</b> (2006.01) <b>A01N 53/00</b> (2006.01) <b>A01P 7/04</b> (2006.01)	P20231659	<b>A61B 17/00</b> (2006.01) <b>A44C 7/00</b> (2006.01)
P20231614	<b>C07D 487/04</b> (2006.01) <b>A61P 35/00</b> (2006.01) <b>A61K 31/519</b> (2006.01) <b>C07D 403/04</b> (2006.01) <b>C07D 403/14</b> (2006.01)	P20231634	<b>H04N 19/159</b> (2014.01) <b>H04N 19/18</b> (2014.01) <b>H04N 19/132</b> (2014.01) <b>H04N 19/12</b> (2014.01)	P20231660	<b>B41J 2/045</b> (2006.01)
		P20231635	<b>B65D 21/02</b> (2006.01) <b>B65D 81/26</b> (2006.01) <b>B65D 1/22</b> (2006.01) <b>A47L 19/04</b> (2006.01)	P20231661	<b>A61P 3/04</b> (2006.01) <b>A61K 31/472</b> (2006.01) <b>A61K 31/4725</b> (2006.01) <b>A61K 31/495</b> (2006.01) <b>A61K 31/4985</b> (2006.01)
		P20231637	<b>C12N 15/11</b> (2006.01) <b>C07K 14/705</b> (2006.01) <b>C12Q 1/6883</b> (2018.01)	P20231662	<b>A01N 31/06</b> (2006.01) <b>A01N 65/22</b> (2009.01) <b>A01N 25/04</b> (2006.01) <b>A01N 25/28</b> (2006.01) <b>A01P 17/00</b> (2006.01)
		P20231639	<b>A61P 11/00</b> (2006.01) <b>C07D 239/69</b> (2006.01) <b>C07D 515/08</b> (2006.01)	P20231663	<b>A61P 25/28</b> (2006.01) <b>C07D 498/04</b> (2006.01) <b>A61K 31/5365</b> (2006.01)
				P20231664	<b>C12N 15/09</b> (2006.01) <b>C07K 16/28</b> (2006.01) <b>C12N 5/00</b> (2006.01) <b>A61K 39/395</b> (2006.01) <b>C12P 21/08</b> (2006.01) <b>A61P 31/12</b> (2006.01) <b>A61P 35/00</b> (2006.01) <b>A61P 37/04</b> (2006.01)
				P20231665	<b>A24B 15/00</b> (2006.01)
				P20231666	<b>E02F 9/28</b> (2006.01) <b>E02F 9/26</b> (2006.01)
				P20231667	<b>A61K 47/34</b> (2017.01) <b>A61K 9/00</b> (2006.01) <b>A61K 31/445</b> (2006.01)



Broj patenta (11)	MKP (51)	Broj patenta (11)	MKP (51)	Broj patenta (11)	MKP (51)
P20231668	<b>C07F 9/38</b> (2006.01)	P20231695	<b>H04N 19/105</b> (2014.01)	P20231727	<b>C12M 1/00</b> (2006.01)
P20231669	<b>H04N 19/52</b> (2014.01)		<b>H04N 19/513</b> (2014.01)		<b>C12M 1/12</b> (2006.01)
P20231670	<b>A61K 9/20</b> (2006.01)		<b>H04N 19/132</b> (2014.01)	P20231729	<b>A61K 9/00</b> (2006.01)
	<b>A61K 31/5377</b> (2006.01)		<b>H04N 19/176</b> (2014.01)		<b>A61K 47/02</b> (2006.01)
P20231672	<b>A61M 25/10</b> (2013.01)		<b>H04N 19/70</b> (2014.01)		<b>A61K 47/10</b> (2017.01)
	<b>A61B 17/22</b> (2006.01)	P20231696	<b>H04N 19/174</b> (2014.01)		<b>A61K 31/40</b> (2006.01)
P20231673	<b>C07D 471/04</b> (2006.01)		<b>A24F 40/42</b> (2020.01)		<b>A61K 31/573</b> (2006.01)
	<b>A61K 31/519</b> (2006.01)		<b>A61M 15/06</b> (2006.01)		<b>A61P 11/00</b> (2006.01)
	<b>A61P 35/00</b> (2006.01)		<b>A61M 11/04</b> (2006.01)		<b>A61P 43/00</b> (2006.01)
P20231674	<b>A63F 1/14</b> (2006.01)		<b>H02J 7/00</b> (2006.01)	P20231732	<b>A61K 31/167</b> (2006.01)
	<b>A63F 1/06</b> (2006.01)		<b>A24F 40/90</b> (2020.01)		<b>A61K 38/21</b> (2006.01)
P20231676	<b>C07C 403/24</b> (2006.01)		<b>A24F 40/40</b> (2020.01)		<b>A61K 47/60</b> (2017.01)
	<b>A61K 31/22</b> (2006.01)		<b>A24F 40/50</b> (2020.01)		<b>A61P 35/00</b> (2006.01)
	<b>A61P 9/00</b> (2006.01)	P20231697	<b>A24F 40/10</b> (2020.01)		<b>A61P 7/00</b> (2006.01)
P20231680	<b>B28C 1/18</b> (2006.01)		<b>C07D 295/205</b> (2006.01)		<b>A61P 19/00</b> (2006.01)
	<b>C04B 33/20</b> (2006.01)		<b>C07C 57/15</b> (2006.01)		<b>A61P 19/04</b> (2006.01)
	<b>C04B 33/30</b> (2006.01)		<b>A61P 29/00</b> (2006.01)		<b>A61P 19/08</b> (2006.01)
	<b>B28B 17/02</b> (2006.01)		<b>A61P 25/00</b> (2006.01)		<b>A61P 31/00</b> (2006.01)
	<b>B28B 3/02</b> (2006.01)	P20231698	<b>A61K 31/496</b> (2006.01)	P20231734	<b>A61P 35/02</b> (2006.01)
P20231683	<b>A01N 37/02</b> (2006.01)		<b>A24B 15/00</b> (2006.01)		<b>A61P 35/00</b> (2006.01)
	<b>A01N 47/36</b> (2006.01)	P20231700	<b>B25B 27/02</b> (2006.01)		<b>A61K 31/4747</b> (2006.01)
	<b>A01P 13/00</b> (2006.01)		<b>B25B 5/14</b> (2006.01)		<b>C07D 487/10</b> (2006.01)
P20231688	<b>B44C 5/04</b> (2006.01)		<b>B25B 27/10</b> (2006.01)	P20231735	<b>A61K 31/137</b> (2006.01)
P20231689	<b>F16B 7/18</b> (2006.01)		<b>B21D 39/04</b> (2006.01)		<b>A61P 15/00</b> (2006.01)
	<b>F16B 37/04</b> (2006.01)		<b>F16L 13/14</b> (2006.01)		<b>A61P 25/00</b> (2006.01)
P20231690	<b>C07D 307/87</b> (2006.01)	P20231703	<b>A61F 7/10</b> (2006.01)	P20231736	<b>H04N 19/196</b> (2014.01)
	<b>C07D 231/12</b> (2006.01)		<b>A61C 19/06</b> (2006.01)		<b>H04N 19/46</b> (2014.01)
	<b>C07D 241/12</b> (2006.01)		<b>A61C 19/08</b> (2006.01)		<b>H04N 19/436</b> (2014.01)
	<b>C07D 249/08</b> (2006.01)		<b>A61F 7/12</b> (2006.01)		<b>H04N 19/91</b> (2014.01)
	<b>C07D 233/56</b> (2006.01)		<b>A61C 1/00</b> (2006.01)	P20231737	<b>H04N 19/196</b> (2014.01)
	<b>C07D 237/08</b> (2006.01)		<b>A61F 7/00</b> (2006.01)		<b>H04N 19/46</b> (2014.01)
	<b>C07D 239/26</b> (2006.01)		<b>A61F 7/02</b> (2006.01)		<b>H04N 19/436</b> (2014.01)
	<b>A61K 31/343</b> (2006.01)	P20231706	<b>A61K 31/4402</b> (2006.01)		<b>H04N 19/91</b> (2014.01)
	<b>A61K 31/415</b> (2006.01)		<b>A61P 27/16</b> (2006.01)	P20231738	<b>B44B 5/00</b> (2006.01)
	<b>A61K 31/4164</b> (2006.01)		<b>A61K 47/32</b> (2006.01)		<b>B44B 5/02</b> (2006.01)
	<b>A61K 31/4965</b> (2006.01)	P20231707	<b>A61K 9/08</b> (2006.01)	P20231739	<b>C07K 16/08</b> (2006.01)
	<b>A61P 29/00</b> (2006.01)		<b>A01K 67/0278</b> (2024.01)		<b>C07K 16/08</b> (2006.01)
	<b>A61P 37/00</b> (2006.01)		<b>G01N 33/50</b> (2006.01)		<b>A61P 13/12</b> (2006.01)
P20231691	<b>A61K 31/353</b> (2006.01)		<b>C07K 14/705</b> (2006.01)		<b>A61P 31/12</b> (2006.01)
	<b>A61K 9/20</b> (2006.01)		<b>C07K 16/28</b> (2006.01)		<b>A61P 31/20</b> (2006.01)
	<b>A61K 9/28</b> (2006.01)		<b>A61P 35/00</b> (2006.01)		<b>A61P 37/06</b> (2006.01)
	<b>A61K 36/45</b> (2006.01)	P20231712	<b>C07K 14/47</b> (2006.01)	P20231741	<b>H01L 31/0224</b> (2006.01)
	<b>A61P 1/00</b> (2006.01)		<b>A63B 71/02</b> (2006.01)		<b>H01L 31/0747</b> (2012.01)
	<b>A61P 1/04</b> (2006.01)	P20231716	<b>A61K 9/00</b> (2006.01)	P20231742	<b>C07C 333/04</b> (2006.01)
P20231692	<b>A61K 9/10</b> (2006.01)		<b>A61K 47/18</b> (2017.01)	P20231748	<b>C07D 413/14</b> (2006.01)
	<b>A61K 47/02</b> (2006.01)		<b>A61K 47/20</b> (2006.01)		<b>A61K 9/14</b> (2006.01)
	<b>A61K 31/47</b> (2006.01)		<b>A61K 47/22</b> (2006.01)		<b>A61K 9/20</b> (2006.01)
	<b>A61P 35/00</b> (2006.01)		<b>A61K 31/198</b> (2006.01)		<b>A61P 35/00</b> (2006.01)
	<b>A61P 43/00</b> (2006.01)	P20231723	<b>A61K 31/133</b> (2006.01)	P20231749	<b>C12N 15/62</b> (2006.01)
P20231694	<b>A61K 31/7034</b> (2006.01)		<b>A61P 25/16</b> (2006.01)		<b>C07K 14/33</b> (2006.01)
	<b>A61K 31/198</b> (2006.01)		<b>B60H 1/00</b> (2006.01)		<b>A61K 39/08</b> (2006.01)
	<b>A61K 31/351</b> (2006.01)		<b>B60H 1/14</b> (2006.01)		<b>A61K 39/00</b> (2006.01)
	<b>A61K 31/401</b> (2006.01)		<b>B60H 1/22</b> (2006.01)		<b>C07K 16/12</b> (2006.01)
	<b>A61K 38/28</b> (2006.01)	P20231724	<b>E04F 19/08</b> (2006.01)		<b>C12N 15/70</b> (2006.01)
	<b>A61K 9/08</b> (2006.01)		<b>H02G 3/08</b> (2006.01)		
	<b>A61P 25/00</b> (2006.01)	P20231725	<b>B65D 1/18</b> (2006.01)		
	<b>A61P 29/00</b> (2006.01)		<b>B65D 1/48</b> (2006.01)		
	<b>A61P 43/00</b> (2006.01)		<b>B65D 25/34</b> (2006.01)		
	<b>A61P 3/00</b> (2006.01)		<b>B65D 43/02</b> (2006.01)		
	<b>A61P 3/10</b> (2006.01)		<b>B65D 43/16</b> (2006.01)		
	<b>A61P 5/50</b> (2006.01)	P20231726	<b>B65D 75/22</b> (2006.01)		
	<b>A61P 9/10</b> (2006.01)		<b>H04N 19/43</b> (2014.01)		

# Kazalo klasifikacijskih oznaka europskih patenata prema Međunarodnoj klasifikaciji patenata

MKP (51)	Broj patenta (11)	Naziv izuma (54)
<b>A01K 67/0278</b> (2024.01)	P20231707	ŽIVOTINJE KOJE NISU LJUDI, KOJE SADRŽE HUMANIZIRANI GEN IZ DIFERENCIJACIJSKE SKUPINE 47 NON-HUMAN ANIMALS HAVING A HUMANIZED CLUSTER OF DIFFERENTIATION 47 GENE
<b>A01K 67/033</b> (2006.01)	P20231594	PROIZVODNA LINIJA S PROTOČNIM SUSTAVOM GRIJANJA I/ILI HLAĐENJA HRANE I GRIJANOM POVRŠINOM ZA RAZMNOŽAVANJE I/ILI UZGOJ INSEKATA, METODA UZGOJA INSEKATA I NJENA UPOTREBA PRODUCTION LINE WITH FLOW-THROUGH FEED HEATING AND/OR COOLING SYSTEM AND HEATED SURFACE FOR BREEDING INSECTS, METHOD FOR BREEDING INSECTS AND USES THEREOF
<b>A01K 67/033</b> (2006.01)	P20231595	PROIZVODNA POVRŠINA SA SUSTAVOM PODNOG GRIJANJA I/ILI HLAĐENJA HRANE ZA INSEKTE, UPOTREBA PODNOG SUSTAVA I NAČIN UZGOJA INSEKATA POMOĆU NJEGA PRODUCTION SURFACE WITH SYSTEM OF UNDERFLOOR HEATING AND/OR COOLING OF INSECT FEED, USE OF UNDERFLOOR SYSTEM AND METHOD FOR REARING INSECTS USING THEREOF
<b>A01N 25/04</b> (2006.01)	P20231662	REPELENTNI PRIPRAVAK PROTIV INSEKATA PRENOSITELJA TROPSKIH BOLESTI U OBLIKU SPREJA REPELLING SPRAY COMPOSITION AGAINST VECTOR INSECTS OF TROPICAL DISEASES
<b>A01N 25/28</b> (2006.01)	P20231633	MIKROKAPSULE KOJE INKAPSULIRAJU LAMBDA-CIHALOTRIN MICROCAPSULES ENCAPSULATING LAMBDA-CYHALOTHRIN
<b>A01N 25/28</b> (2006.01)	P20231662	REPELENTNI PRIPRAVAK PROTIV INSEKATA PRENOSITELJA TROPSKIH BOLESTI U OBLIKU SPREJA REPELLING SPRAY COMPOSITION AGAINST VECTOR INSECTS OF TROPICAL DISEASES
<b>A01N 31/06</b> (2006.01)	P20231662	REPELENTNI PRIPRAVAK PROTIV INSEKATA PRENOSITELJA TROPSKIH BOLESTI U OBLIKU SPREJA REPELLING SPRAY COMPOSITION AGAINST VECTOR INSECTS OF TROPICAL DISEASES
<b>A01N 37/02</b> (2006.01)	P20231683	SINERGIJSKI UČINKOVIT HERBICIDNI SASTAV KOJI SADRŽI PELARGONSKU KISELINU I FLAZASULFURON SYNERGISTICALLY EFFECTIVE HERBICIDE COMPOSITION COMPRISING PELARGONIC ACID AND FLAZASULFURON
<b>A01N 47/36</b> (2006.01)	P20231683	SINERGIJSKI UČINKOVIT HERBICIDNI SASTAV KOJI SADRŽI PELARGONSKU KISELINU I FLAZASULFURON SYNERGISTICALLY EFFECTIVE HERBICIDE COMPOSITION COMPRISING PELARGONIC ACID AND FLAZASULFURON
<b>A01N 53/00</b> (2006.01)	P20231633	MIKROKAPSULE KOJE INKAPSULIRAJU LAMBDA-CIHALOTRIN MICROCAPSULES ENCAPSULATING LAMBDA-CYHALOTHRIN
<b>A01N 65/22</b> (2009.01)	P20231662	REPELENTNI PRIPRAVAK PROTIV INSEKATA PRENOSITELJA TROPSKIH BOLESTI U OBLIKU SPREJA REPELLING SPRAY COMPOSITION AGAINST VECTOR INSECTS OF TROPICAL DISEASES
<b>A01P 13/00</b> (2006.01)	P20231683	SINERGIJSKI UČINKOVIT HERBICIDNI SASTAV KOJI SADRŽI PELARGONSKU KISELINU I FLAZASULFURON SYNERGISTICALLY EFFECTIVE HERBICIDE COMPOSITION COMPRISING PELARGONIC ACID AND FLAZASULFURON
<b>A01P 17/00</b> (2006.01)	P20231662	REPELENTNI PRIPRAVAK PROTIV INSEKATA PRENOSITELJA TROPSKIH BOLESTI U OBLIKU SPREJA REPELLING SPRAY COMPOSITION AGAINST VECTOR INSECTS OF TROPICAL DISEASES
<b>A01P 7/04</b> (2006.01)	P20231633	MIKROKAPSULE KOJE INKAPSULIRAJU LAMBDA-CIHALOTRIN MICROCAPSULES ENCAPSULATING LAMBDA-CYHALOTHRIN
<b>A23C 19/02</b> (2006.01)	P20231649	NAČIN IZRADE KOZJEG SIRA FRANCUSKOG TIPA METHOD OF MAKING FRENCH-TYPE GOAT CHEESE
<b>A23C 19/028</b> (2006.01)	P20231649	NAČIN IZRADE KOZJEG SIRA FRANCUSKOG TIPA METHOD OF MAKING FRENCH-TYPE GOAT CHEESE
<b>A23C 19/05</b> (2006.01)	P20231649	NAČIN IZRADE KOZJEG SIRA FRANCUSKOG TIPA METHOD OF MAKING FRENCH-TYPE GOAT CHEESE
<b>A23C 19/076</b> (2006.01)	P20231649	NAČIN IZRADE KOZJEG SIRA FRANCUSKOG TIPA METHOD OF MAKING FRENCH-TYPE GOAT CHEESE
<b>A23C 9/142</b> (2006.01)	P20231649	NAČIN IZRADE KOZJEG SIRA FRANCUSKOG TIPA METHOD OF MAKING FRENCH-TYPE GOAT CHEESE
<b>A23L 7/109</b> (2016.01)	P20231648	POSTUPAK ZA PROIZVODNJU PREHRAMBENOG PROIZVODA OD TJESTENINE EKSTRUZIJOM KROZ UMETAK NAPRAVLJEN OD POLIACETALNE SMOLE I SRODNI PROIZVOD PROCESS FOR THE PRODUCTION OF A PASTA FOOD PRODUCT BY EXTRUSION THROUGH AN INSERT MADE OF POLYACETAL RESIN AND RELATED PRODUCT

MKP (51)	Broj patenta (11)	Naziv izuma (54)
<b>A23P 30/20</b> (2016.01)	P20231648	POSTUPAK ZA PROIZVODNJU PREHRAMBENOG PROIZVODA OD TJESTENINE EKSTRUZIJOM KROZ UMETAK NAPRAVLJEN OD POLIACETALNE SMOLE I SRODNI PROIZVOD PROCESS FOR THE PRODUCTION OF A PASTA FOOD PRODUCT BY EXTRUSION THROUGH AN INSERT MADE OF POLYACETAL RESIN AND RELATED PRODUCT
<b>A24B 15/00</b> (2006.01)	P20231665	STVARANJE AEROSOLA AEROSOL GENERATION
<b>A24B 15/00</b> (2006.01)	P20231698	GENERIRANJE AEROSOLA AEROSOL GENERATION
<b>A24F 40/10</b> (2020.01)	P20231605	PATRONA I POSTUPAK ISPARAVANJA U SUSTAVU PATRONA S DIFUZOROM CARTRIDGE AND METHOD FOR VAPORIZING IN A CARTRIDGE SYSTEM WITH DIFFUSER
<b>A24F 40/10</b> (2020.01)	P20231696	VAPORIZATOR VAPORIZER
<b>A24F 40/40</b> (2020.01)	P20231696	VAPORIZATOR VAPORIZER
<b>A24F 40/42</b> (2020.01)	P20231696	VAPORIZATOR VAPORIZER
<b>A24F 40/48</b> (2020.01)	P20231605	PATRONA I POSTUPAK ISPARAVANJA U SUSTAVU PATRONA S DIFUZOROM CARTRIDGE AND METHOD FOR VAPORIZING IN A CARTRIDGE SYSTEM WITH DIFFUSER
<b>A24F 40/485</b> (2020.01)	P20231605	PATRONA I POSTUPAK ISPARAVANJA U SUSTAVU PATRONA S DIFUZOROM CARTRIDGE AND METHOD FOR VAPORIZING IN A CARTRIDGE SYSTEM WITH DIFFUSER
<b>A24F 40/50</b> (2020.01)	P20231696	VAPORIZATOR VAPORIZER
<b>A24F 40/90</b> (2020.01)	P20231696	VAPORIZATOR VAPORIZER
<b>A41D 19/00</b> (2006.01)	P20231647	STRUKTURA RUKAVICE GLOVE STRUCTURE
<b>A41D 19/015</b> (2006.01)	P20231647	STRUKTURA RUKAVICE GLOVE STRUCTURE
<b>A41D 19/02</b> (2006.01)	P20231647	STRUKTURA RUKAVICE GLOVE STRUCTURE
<b>A44C 7/00</b> (2006.01)	P20231659	JEDNOKRATNI RUČNI ULOŽAK INSTRUMENTA ZA PROBIJANJE TIJELA DISPOSABLE HAND OPERATED CARTRIDGE BODY PIERCING INSTRUMENT
<b>A45D 24/30</b> (2006.01)	P20231646	ČEŠALJ ZA LIJEČENJE PEDIKULOZE COMB FOR THE TREATMENT OF PEDICULOSIS
<b>A47J 31/02</b> (2006.01)	P20231551	FILTER ZA PRIPREMU KAVE ILI INFUZIJE FILTER FOR PREPARING COFFEE OR INFUSION
<b>A47L 19/04</b> (2006.01)	P20231635	KUTIJA KOJU SE MOŽE NASLAGIVATI STACKABLE TRAY
<b>A61B 17/00</b> (2006.01)	P20231659	JEDNOKRATNI RUČNI ULOŽAK INSTRUMENTA ZA PROBIJANJE TIJELA DISPOSABLE HAND OPERATED CARTRIDGE BODY PIERCING INSTRUMENT
<b>A61B 17/22</b> (2006.01)	P20231672	BALONSKI KATETER BALLOON CATHETER
<b>A61C 1/00</b> (2006.01)	P20231703	USNIK ZA HLAĐENJE TKIVA USNE ŠUPLJINE MOUTH PIECE FOR COOLING OF ORAL TISSUE
<b>A61C 19/06</b> (2006.01)	P20231703	USNIK ZA HLAĐENJE TKIVA USNE ŠUPLJINE MOUTH PIECE FOR COOLING OF ORAL TISSUE
<b>A61C 19/08</b> (2006.01)	P20231703	USNIK ZA HLAĐENJE TKIVA USNE ŠUPLJINE MOUTH PIECE FOR COOLING OF ORAL TISSUE
<b>A61F 2/00</b> (2006.01)	P20231632	UREĐAJ ZA POHRANU, NAMIJENJEN ZA PROTEZU DOJKE PRILIKOM REKONSTRUKTIVNE KIRURGIJE DOJKE CONTAINER DEVICE FOR BREAST PROSTHESIS FOR RECONSTRUCTIVE BREAST SURGERY
<b>A61F 2/12</b> (2006.01)	P20231632	UREĐAJ ZA POHRANU, NAMIJENJEN ZA PROTEZU DOJKE PRILIKOM REKONSTRUKTIVNE KIRURGIJE DOJKE CONTAINER DEVICE FOR BREAST PROSTHESIS FOR RECONSTRUCTIVE BREAST SURGERY
<b>A61F 7/00</b> (2006.01)	P20231703	USNIK ZA HLAĐENJE TKIVA USNE ŠUPLJINE MOUTH PIECE FOR COOLING OF ORAL TISSUE
<b>A61F 7/02</b> (2006.01)	P20231703	USNIK ZA HLAĐENJE TKIVA USNE ŠUPLJINE MOUTH PIECE FOR COOLING OF ORAL TISSUE
<b>A61F 7/10</b> (2006.01)	P20231703	USNIK ZA HLAĐENJE TKIVA USNE ŠUPLJINE MOUTH PIECE FOR COOLING OF ORAL TISSUE
<b>A61F 7/12</b> (2006.01)	P20231703	USNIK ZA HLAĐENJE TKIVA USNE ŠUPLJINE MOUTH PIECE FOR COOLING OF ORAL TISSUE
<b>A61K 31/03</b> (2006.01)	P20231641	FARMACEUTSKI PRIPRAVAK KOJI SADRŽI MITOTAN ZA ORALNU PRIMJENU ZA LIJEČENJE ADRENOKORTIKALNOG KARCINOMA I CUSHINGOVOG SINDROMA PHARMACEUTICAL COMPOSITION COMPRISING MITOTANE FOR ORAL ADMINISTRATION FOR USE IN THE TREATMENT OF ADRENOCORTICAL CARCINOMA AND CUSHING-SYNDROME
<b>A61K 31/04</b> (2006.01)	P20231584	POSTUPAK ZA PODRŠKU MEMORIJSKOJ FUNKCIJI I/ILI KOGNITIVNOJ FUNKCIJI METHOD FOR SUPPORTING MEMORY FUNCTION AND/OR COGNITIVE FUNCTION
<b>A61K 31/12</b> (2006.01)	P20231591	SOLUBILIZAT S KURKUMINOM I BAREM JEDNOM DRUGOM AKTIVNOM TVARI SOLUBILISATE WITH CURCUMIN AND AT LEAST ONE OTHER ACTIVE SUBSTANCE

MKP (51)	Broj patenta (11)	Naziv izuma (54)
<b>A61K 31/133</b> (2006.01)	P20231716	PRIPRAVCI INHIBITORA DOPA DEKARBOKSILAZE DOPA DECARBOXYLASE INHIBITOR COMPOSITIONS
<b>A61K 31/137</b> (2006.01)	P20231735	LIJEČENJE SIMPTOMA IZAZVANIH MENSTRUALNIM CIKLUSOM TREATMENT OF MENSTRUAL CYCLE-INDUCED SYMPTOMS
<b>A61K 31/167</b> (2006.01)	P20231729	KOMBINIRANA TERAPIJA ZA KOPB COMBINATION THERAPY FOR COPD
<b>A61K 31/18</b> (2006.01)	P20231582	NOVI DERIVATI TRITERPENA KAO INHIBITORI HIV-A NOVEL TRITERPENE DERIVATIVES AS HIV INHIBITORS
<b>A61K 31/198</b> (2006.01)	P20231572	POSTUPCI I PRIPRAVCI ZA LIJEČENJE PRETILOSTI, SPREČAVANJE DOBIVANJA NA TEŽINI, PROMICANJE GUBITKA TEŽINE, PROMICANJE MRŠAVLJENJA, ILI LIJEČENJE ILI PREVENCIJU RAZVOJA DIJABETESA METHODS AND COMPOSITIONS FOR TREATING OBESITY, PREVENTING WEIGHT GAIN, PROMOTING WEIGHT LOSS, PROMOTING SLIMMING, OR TREATING OR PREVENTING THE DEVELOPMENT OF DIABETES
<b>A61K 31/198</b> (2006.01)	P20231694	SGLT-2 INHIBITOR ZA UPORABU U LIJEČENJU METABOLIČKOG POREMEĆAJA KOD ŽIVOTINJA IZ PORODICE MAČAKA AN SGLT-2 INHIBITOR FOR USE IN THE TREATMENT OF A METABOLIC DISORDER IN FELINE ANIMALS
<b>A61K 31/198</b> (2006.01)	P20231716	PRIPRAVCI INHIBITORA DOPA DEKARBOKSILAZE DOPA DECARBOXYLASE INHIBITOR COMPOSITIONS
<b>A61K 31/202</b> (2006.01)	P20231584	POSTUPAK ZA PODRŠKU MEMORIJSKOJ FUNKCIJI I/ILI KOGNITIVNOJ FUNKCIJI METHOD FOR SUPPORTING MEMORY FUNCTION AND/OR COGNITIVE FUNCTION
<b>A61K 31/205</b> (2006.01)	P20231572	POSTUPCI I PRIPRAVCI ZA LIJEČENJE PRETILOSTI, SPREČAVANJE DOBIVANJA NA TEŽINI, PROMICANJE GUBITKA TEŽINE, PROMICANJE MRŠAVLJENJA, ILI LIJEČENJE ILI PREVENCIJU RAZVOJA DIJABETESA METHODS AND COMPOSITIONS FOR TREATING OBESITY, PREVENTING WEIGHT GAIN, PROMOTING WEIGHT LOSS, PROMOTING SLIMMING, OR TREATING OR PREVENTING THE DEVELOPMENT OF DIABETES
<b>A61K 31/22</b> (2006.01)	P20231676	ESTERI AMARUCIAKSANTINA A I NJIHOVA UPOTREBA AMAROUCIAXANTHIN A ESTERS AND USES THEREOF
<b>A61K 31/221</b> (2006.01)	P20231576	DERIVATI SULFOPROPANSKE KISELINE ZA LIJEČENJE NEURODEGENERATIVNIH POREMEĆAJA SULFOPROPANOIC ACID DERIVATIVES FOR TREATING NEURODEGENERATIVE DISORDERS
<b>A61K 31/222</b> (2006.01)	P20231576	DERIVATI SULFOPROPANSKE KISELINE ZA LIJEČENJE NEURODEGENERATIVNIH POREMEĆAJA SULFOPROPANOIC ACID DERIVATIVES FOR TREATING NEURODEGENERATIVE DISORDERS
<b>A61K 31/223</b> (2006.01)	P20231576	DERIVATI SULFOPROPANSKE KISELINE ZA LIJEČENJE NEURODEGENERATIVNIH POREMEĆAJA SULFOPROPANOIC ACID DERIVATIVES FOR TREATING NEURODEGENERATIVE DISORDERS
<b>A61K 31/225</b> (2006.01)	P20231576	DERIVATI SULFOPROPANSKE KISELINE ZA LIJEČENJE NEURODEGENERATIVNIH POREMEĆAJA SULFOPROPANOIC ACID DERIVATIVES FOR TREATING NEURODEGENERATIVE DISORDERS
<b>A61K 31/255</b> (2006.01)	P20231576	DERIVATI SULFOPROPANSKE KISELINE ZA LIJEČENJE NEURODEGENERATIVNIH POREMEĆAJA SULFOPROPANOIC ACID DERIVATIVES FOR TREATING NEURODEGENERATIVE DISORDERS
<b>A61K 31/277</b> (2006.01)	P20231572	POSTUPCI I PRIPRAVCI ZA LIJEČENJE PRETILOSTI, SPREČAVANJE DOBIVANJA NA TEŽINI, PROMICANJE GUBITKA TEŽINE, PROMICANJE MRŠAVLJENJA, ILI LIJEČENJE ILI PREVENCIJU RAZVOJA DIJABETESA METHODS AND COMPOSITIONS FOR TREATING OBESITY, PREVENTING WEIGHT GAIN, PROMOTING WEIGHT LOSS, PROMOTING SLIMMING, OR TREATING OR PREVENTING THE DEVELOPMENT OF DIABETES
<b>A61K 31/343</b> (2006.01)	P20231690	SELEKTIVNI INHIBITORI NLRP3 INFLAMASOMA SELECTIVE INHIBITORS OF NLRP3 INFLAMMASOME
<b>A61K 31/351</b> (2006.01)	P20231694	SGLT-2 INHIBITOR ZA UPORABU U LIJEČENJU METABOLIČKOG POREMEĆAJA KOD ŽIVOTINJA IZ PORODICE MAČAKA AN SGLT-2 INHIBITOR FOR USE IN THE TREATMENT OF A METABOLIC DISORDER IN FELINE ANIMALS
<b>A61K 31/352</b> (2006.01)	P20231591	SOLUBILIZAT S KURKUMINOM I BAREM JEDNOM DRUGOM AKTIVNOM TVARI SOLUBILISATE WITH CURCUMIN AND AT LEAST ONE OTHER ACTIVE SUBSTANCE
<b>A61K 31/353</b> (2006.01)	P20231691	PRIPRAVAK ZA UPOTREBU U LIJEČENJU PROMJENA U CRIJEVIMA COMPOSITION FOR USE IN THE TREATMENT OF INTESTINAL ALTERATIONS
<b>A61K 31/375</b> (2006.01)	P20231584	POSTUPAK ZA PODRŠKU MEMORIJSKOJ FUNKCIJI I/ILI KOGNITIVNOJ FUNKCIJI METHOD FOR SUPPORTING MEMORY FUNCTION AND/OR COGNITIVE FUNCTION
<b>A61K 31/40</b> (2006.01)	P20231609	KONJUGATI LIJEKA KOJI SADRŽE ANTITIJELA PROTIV KLAUDINA 18.2 DRUG CONJUGATES COMPRISING ANTIBODIES AGAINST CLAUDIN 18.2
<b>A61K 31/40</b> (2006.01)	P20231729	KOMBINIRANA TERAPIJA ZA KOPB COMBINATION THERAPY FOR COPD
<b>A61K 31/401</b> (2006.01)	P20231694	SGLT-2 INHIBITOR ZA UPORABU U LIJEČENJU METABOLIČKOG POREMEĆAJA KOD ŽIVOTINJA IZ PORODICE MAČAKA AN SGLT-2 INHIBITOR FOR USE IN THE TREATMENT OF A METABOLIC DISORDER IN FELINE ANIMALS

MKP (51)	Broj patenta (11)	Naziv izuma (54)
<b>A61K 31/404</b> (2006.01)	P20231163	PROLIJEKOVI GLUTAMINSKIH ANALOGA PRODRUGS OF GLUTAMINE ANALOGS
<b>A61K 31/4045</b> (2006.01)	P20231653	STABILNI FARMACEUTSKI SASTAVI ROPINIROLA STABLE PHARMACEUTICAL COMPOSITIONS OF ROPINIROLE
<b>A61K 31/415</b> (2006.01)	P20231690	SELEKTIVNI INHIBITORI NLRP3 INFLAMASOMA SELECTIVE INHIBITORS OF NLRP3 INFLAMMASOME
<b>A61K 31/4164</b> (2006.01)	P20231690	SELEKTIVNI INHIBITORI NLRP3 INFLAMASOMA SELECTIVE INHIBITORS OF NLRP3 INFLAMMASOME
<b>A61K 31/4402</b> (2006.01)	P20231706	INTRANAZALNI PRIPRAVAK KOJI SADRŽI BETAHISTIN INTRANASAL COMPOSITION COMPRISING BETAHISTINE
<b>A61K 31/4418</b> (2006.01)	P20231547	POSTUPCI LIJEČENJA MULTIPLE SKLEROZE PRIMJENOM SPOJEVA PIRIMIDINA I PIRIDINA S AKTIVNOŠĆU INHIBICIJE BTK METHODS FOR TREATING MULTIPLE SCLEROSIS USING PYRIMIDINE AND PYRIDINE COMPOUNDS WITH BTK INHIBITORY ACTIVITY
<b>A61K 31/4439</b> (2006.01)	P20231586	AGONISTI RECEPTORA GLUCAGONU SLIČNOG PEPTIDA 1 GLUCAGON-LIKE PEPTIDE 1 RECEPTOR AGONISTS
<b>A61K 31/444</b> (2006.01)	P20231587	KRONIČNO NOĆNO DOZIRANJE LASMIDITANA RADI SPRJEČAVANJA MIGRENE CHRONIC NIGHTLY DOSING OF LASMIDITAN FOR MIGRAINE PREVENTION
<b>A61K 31/445</b> (2006.01)	P20231667	FARMACEUTSKI PRIPRAVAK PHARMACEUTICAL COMPOSITION
<b>A61K 31/454</b> (2006.01)	P20231608	DERIVATI PIRIDINIL SULFONAMIDA, NJIHOVI FARMACEUTSKI PRIPRAVCI I NJIHOVE UPORABE PYRIDINYL SULFONAMIDE DERIVATIVES, PHARMACEUTICAL COMPOSITIONS AND USES THEREOF
<b>A61K 31/4545</b> (2006.01)	P20231568	NOVA TERAPIJSKA UPOTREBA H3-LIGANADA NEW THERAPEUTICAL USE OF H3-LIGANDS
<b>A61K 31/4545</b> (2006.01)	P20231608	DERIVATI PIRIDINIL SULFONAMIDA, NJIHOVI FARMACEUTSKI PRIPRAVCI I NJIHOVE UPORABE PYRIDINYL SULFONAMIDE DERIVATIVES, PHARMACEUTICAL COMPOSITIONS AND USES THEREOF
<b>A61K 31/47</b> (2006.01)	P20231588	KOMBINACIJA KOJA SADRŽI STABILNI KRISTAL 4-OXSOKINOLINSKOG SPOJA COMBINATION COMPRISING A STABLE CRYSTAL OF A 4-OXOQUINOLINE COMPOUND
<b>A61K 31/47</b> (2006.01)	P20231692	POSTUPAK ZA SUZBIJANJE GORČINE DERIVATA KINOLINA METHOD FOR SUPPRESSING BITTERNESS OF QUINOLINE DERIVATIVE
<b>A61K 31/472</b> (2006.01)	P20231661	ANTAGONISTI NK-3 RECEPTORA ZA TERAPIJSKO ILI KOZMETIČKO LIJEČENJE VIŠKA TJELESNE MASTI NK-3 RECEPTOR ANTAGONISTS FOR THERAPEUTIC OR COSMETIC TREATMENT OF EXCESS BODY FAT
<b>A61K 31/4725</b> (2006.01)	P20231537	DERIVATI TETRAHIDRONAFTALENA I TETRAHIDROIZOKINOLINA KAO DEGRADATORI ESTROGENSKIH RECEPTORA TETRAHYDRONAPHTHALENE AND TETRAHYDROISOQUINOLINE DERIVATIVES AS ESTROGEN RECEPTOR DEGRADERS
<b>A61K 31/4725</b> (2006.01)	P20231661	ANTAGONISTI NK-3 RECEPTORA ZA TERAPIJSKO ILI KOZMETIČKO LIJEČENJE VIŠKA TJELESNE MASTI NK-3 RECEPTOR ANTAGONISTS FOR THERAPEUTIC OR COSMETIC TREATMENT OF EXCESS BODY FAT
<b>A61K 31/4747</b> (2006.01)	P20231734	TRICIKLIČKI AKR1C3 OVISNI KARS INHIBITORI TRICYCLIC AKR1C3 DEPENDENT KARS INHIBITORS
<b>A61K 31/495</b> (2006.01)	P20231661	ANTAGONISTI NK-3 RECEPTORA ZA TERAPIJSKO ILI KOZMETIČKO LIJEČENJE VIŠKA TJELESNE MASTI NK-3 RECEPTOR ANTAGONISTS FOR THERAPEUTIC OR COSMETIC TREATMENT OF EXCESS BODY FAT
<b>A61K 31/496</b> (2006.01)	P20231697	KRISTALNI OBLIK MAGL INHIBITORA A CRYSTALLINE FORM OF A MAGL INHIBITOR
<b>A61K 31/4965</b> (2006.01)	P20231690	SELEKTIVNI INHIBITORI NLRP3 INFLAMASOMA SELECTIVE INHIBITORS OF NLRP3 INFLAMMASOME
<b>A61K 31/4985</b> (2006.01)	P20231661	ANTAGONISTI NK-3 RECEPTORA ZA TERAPIJSKO ILI KOZMETIČKO LIJEČENJE VIŠKA TJELESNE MASTI NK-3 RECEPTOR ANTAGONISTS FOR THERAPEUTIC OR COSMETIC TREATMENT OF EXCESS BODY FAT
<b>A61K 31/5025</b> (2006.01)	P20231563	4-OKSO-3,4-DIHIDROTINO[3,4-D]PIRIDAZINSKI SPOJEVI KAO INHIBITORI ALDOSOREDUKTAZE I NAČINI NJIHOVE UPOTREBE 4-OXO-3,4-DIHYDROTHIENO[3,4-D]PYRIDAZINE COMPOUNDS AS ALDOSE REDUCTASE INHIBITORS AND METHODS OF USE THEREOF
<b>A61K 31/505</b> (2006.01)	P20231547	POSTUPCI LIJEČENJA MULTIPLE SKLEROZE PRIMJENOM SPOJEVA PIRIMIDINA I PIRIDINA S AKTIVNOŠĆU INHIBICIJE BTK METHODS FOR TREATING MULTIPLE SCLEROSIS USING PYRIMIDINE AND PYRIDINE COMPOUNDS WITH BTK INHIBITORY ACTIVITY
<b>A61K 31/505</b> (2006.01)	P20231571	DERIVATI FENIL/PIRIDIL-NH-FENIL/PIRIDIL ZA LIJEČENJE INFEKCIJA RNA VIRUSOM PHENYL/PYRIDYL-N-PHENYL/PYRIDYL DERIVATIVES FOR TREATING RNA VIRUS INFECTION
<b>A61K 31/506</b> (2006.01)	P20231547	POSTUPCI LIJEČENJA MULTIPLE SKLEROZE PRIMJENOM SPOJEVA PIRIMIDINA I PIRIDINA S AKTIVNOŠĆU INHIBICIJE BTK METHODS FOR TREATING MULTIPLE SCLEROSIS USING PYRIMIDINE AND PYRIDINE COMPOUNDS WITH BTK INHIBITORY ACTIVITY

MKP (51)	Broj patenta (11)	Naziv izuma (54)
<b>A61K 31/506</b> (2006.01)	P20231548	FARMACEUTSKI PRIPRAVAK PHARMACEUTICAL PREPARATION
<b>A61K 31/513</b> (2006.01)	P20231547	POSTUPCI LIJEČENJA MULTIPLE SKLEROZE PRIMJENOM SPOJEVA PIRIMIDINA I PIRIDINA S AKTIVNOŠĆU INHIBICIJE BTK METHODS FOR TREATING MULTIPLE SCLEROSIS USING PYRIMIDINE AND PYRIDINE COMPOUNDS WITH BTK INHIBITORY ACTIVITY
<b>A61K 31/519</b> (2006.01)	P20231614	SPOJEVI PIROLOTRIAZINA KAO TAM INHIBITORI PYRROLOTRIAZINE COMPOUNDS AS TAM INHIBITORS
<b>A61K 31/519</b> (2006.01)	P20231673	INHIBITORI PRMT5 PRMT5 INHIBITORS
<b>A61K 31/5365</b> (2006.01)	P20231663	BICIKLIČKI DERIVATI HETEROARILA BICYCLIC HETEROARYL DERIVATIVES
<b>A61K 31/5377</b> (2006.01)	P20231547	POSTUPCI LIJEČENJA MULTIPLE SKLEROZE PRIMJENOM SPOJEVA PIRIMIDINA I PIRIDINA S AKTIVNOŠĆU INHIBICIJE BTK METHODS FOR TREATING MULTIPLE SCLEROSIS USING PYRIMIDINE AND PYRIDINE COMPOUNDS WITH BTK INHIBITORY ACTIVITY
<b>A61K 31/5377</b> (2006.01)	P20231608	DERIVATI PIRIDINIL SULFONAMIDA, NJIHOVI FARMACEUTSKI PRIPRAVCI I NJIHOVE UPORABE PYRIDINYL SULFONAMIDE DERIVATIVES, PHARMACEUTICAL COMPOSITIONS AND USES THEREOF
<b>A61K 31/5377</b> (2006.01)	P20231670	FARMACEUTSKI PRIPRAVAK ZA ORALNU PRIMJENU KOJI SADRŽI DERIVAT AMINOPYRIMIDINA ILI NJEGOVU SOL PHARMACEUTICAL COMPOSITION FOR ORAL ADMINISTRATION COMPRISING AMINOPYRIMIDINE DERIVATIVE OR ITS SALT
<b>A61K 31/55</b> (2006.01)	P20231547	POSTUPCI LIJEČENJA MULTIPLE SKLEROZE PRIMJENOM SPOJEVA PIRIMIDINA I PIRIDINA S AKTIVNOŠĆU INHIBICIJE BTK METHODS FOR TREATING MULTIPLE SCLEROSIS USING PYRIMIDINE AND PYRIDINE COMPOUNDS WITH BTK INHIBITORY ACTIVITY
<b>A61K 31/55</b> (2006.01)	P20231616	DERIVATI BENZAZEPINA BENZAZEPINE DERIVATIVES
<b>A61K 31/5513</b> (2006.01)	P20231538	FARMACEUTSKI SPOJ, POSTUPAK ZA NJEGOVU IZRADU I UPORABA KAO LIJEKOVITOG SREDSTVA PHARMACEUTICAL COMPOUND, THE METHOD OF ITS MAKING AND USE AS MEDICINAL AGENT
<b>A61K 31/573</b> (2006.01)	P20231729	KOMBINIRANA TERAPIJA ZA KOPB COMBINATION THERAPY FOR COPD
<b>A61K 31/58</b> (2006.01)	P20231582	NOVI DERIVATI TRITERPENA KAO INHIBITORI HIV-A NOVEL TRITERPENE DERIVATIVES AS HIV INHIBITORS
<b>A61K 31/609</b> (2006.01)	P20231613	PRIPRAVCI KOJI SADRŽE SREDSTVO ZA UNOŠENJE I NJIHOVA PRIPRAVA COMPOSITIONS COMPRISING A DELIVERY AGENT AND PREPARATION THEREOF
<b>A61K 31/66</b> (2006.01)	P20231163	PROLIJEKOVI GLUTAMINSKIH ANALOGA PRODRUGS OF GLUTAMINE ANALOGS
<b>A61K 31/7034</b> (2006.01)	P20231694	SGLT-2 INHIBITOR ZA UPORABU U LIJEČENJU METABOLIČKOG POREMEĆAJA KOD ŽIVOTINJA IZ PORODICE MAČAKA AN SGLT-2 INHIBITOR FOR USE IN THE TREATMENT OF A METABOLIC DISORDER IN FELINE ANIMALS
<b>A61K 31/7068</b> (2006.01)	P20231584	POSTUPAK ZA PODRŠKU MEMORIJSKOJ FUNKCIJI I/ILI KOGNITIVNOJ FUNKCIJI METHOD FOR SUPPORTING MEMORY FUNCTION AND/OR COGNITIVE FUNCTION
<b>A61K 31/7072</b> (2006.01)	P20231584	POSTUPAK ZA PODRŠKU MEMORIJSKOJ FUNKCIJI I/ILI KOGNITIVNOJ FUNKCIJI METHOD FOR SUPPORTING MEMORY FUNCTION AND/OR COGNITIVE FUNCTION
<b>A61K 31/7076</b> (2006.01)	P20231163	PROLIJEKOVI GLUTAMINSKIH ANALOGA PRODRUGS OF GLUTAMINE ANALOGS
<b>A61K 31/7088</b> (2006.01)	P20231525	POSTUPCI I PRIPRAVCI ZA DIJAGNOZU I LIJEČENJE RAKA METHODS AND COMPOSITIONS FOR DIAGNOSIS AND TREATMENT OF CANCER
<b>A61K 31/721</b> (2006.01)	P20231644	IMUNOPROFILAKSA PONAVLJANIH BAKTERIJSKIH INFEKCIJA IMMUNOPROPHYLAXIS FOR RECURRENT BACTERIAL INFECTIONS
<b>A61K 36/185</b> (2006.01)	P20231591	SOLUBILIZAT S KURKUMINOM I BAREM JEDNOM DRUGOM AKTIVNOM TVARI SOLUBILISATE WITH CURCUMIN AND AT LEAST ONE OTHER ACTIVE SUBSTANCE
<b>A61K 36/45</b> (2006.01)	P20231691	PRIPRAVAK ZA UPOTREBU U LIJEČENJU PROMJENA U CRIJEVIMA COMPOSITION FOR USE IN THE TREATMENT OF INTESTINAL ALTERATIONS
<b>A61K 36/484</b> (2006.01)	P20231591	SOLUBILIZAT S KURKUMINOM I BAREM JEDNOM DRUGOM AKTIVNOM TVARI SOLUBILISATE WITH CURCUMIN AND AT LEAST ONE OTHER ACTIVE SUBSTANCE
<b>A61K 36/9066</b> (2006.01)	P20231591	SOLUBILIZAT S KURKUMINOM I BAREM JEDNOM DRUGOM AKTIVNOM TVARI SOLUBILISATE WITH CURCUMIN AND AT LEAST ONE OTHER ACTIVE SUBSTANCE
<b>A61K 38/08</b> (2019.01)	P20231567	PEPTIDI IZVEDENI IZ PROPEPTIDA NTSR3 I NJIHOVA UPORABA U LIJEČENJU DEPRESIJE PEPTIDES DERIVED FROM THE PROPEPTIDE NTSR3 AND THEIR USE IN THE TREATMENT OF DEPRESSION
<b>A61K 38/10</b> (2006.01)	P20231567	PEPTIDI IZVEDENI IZ PROPEPTIDA NTSR3 I NJIHOVA UPORABA U LIJEČENJU DEPRESIJE PEPTIDES DERIVED FROM THE PROPEPTIDE NTSR3 AND THEIR USE IN THE TREATMENT OF DEPRESSION
<b>A61K 38/13</b> (2006.01)	P20231621	FORMULACIJE CIKLOSPORINA ZA UPOTREBU U PREVENCIJI ILI LIJEČENJU PLUĆNOG KRONIČNOG ODBACIVANJA TRANSPLANTANTA CYCLOSPORINE FORMULATIONS FOR USE IN THE PREVENTION OR TREATMENT OF PULMONARY CHRONIC GRAFT REJECTION
<b>A61K 38/21</b> (2006.01)	P20231732	REŽIM DOZIRANJA PEGILIRANOG INTERFERONA DOSAGE REGIMEN FOR PEGYLATED INTERFERON

MKP (51)	Broj patenta (11)	Naziv izuma (54)
<b>A61K 38/26</b> (2006.01)	P20231613	PRIPRAVCI KOJI SADRŽE SREDSTVO ZA UNOŠENJE I NJIHOVA PRIPRAVA COMPOSITIONS COMPRISING A DELIVERY AGENT AND PREPARATION THEREOF
<b>A61K 38/28</b> (2006.01)	P20231694	SGLT-2 INHIBITOR ZA UPORABU U LIJEČENJU METABOLIČKOG POREMEĆAJA KOD ŽIVOTINJA IZ PORODICE MAČAKA AN SGLT-2 INHIBITOR FOR USE IN THE TREATMENT OF A METABOLIC DISORDER IN FELINE ANIMALS
<b>A61K 39/00</b> (2006.01)	P20231569	NOVA PROTUTIJELA PROTIV IL 13 I NJIHOVA UPOTREBA NOVEL ANTI-IL 13 ANTIBODIES AND USES THEREOF
<b>A61K 39/00</b> (2006.01)	P20231570	PEPTID ZA UPORABU U IMUNOTERAPIJI PROTIV NESITNOSTANIČNOG RAKA PLUČA I SITNOSTANIČNOG RAKA PLUČA PEPTIDE AND COMBINATION OF PEPTIDES FOR USE IN IMMUNOTHERAPY AGAINST NON- SMALL CELL LUNG CANCER AND OTHER CANCERS
<b>A61K 39/00</b> (2006.01)	P20231578	MOLEKULE PROTUTIJELA NA APRIL I NJIHOVE UPORABE ANTIBODY MOLECULES TO APRIL AND USES THEREOF
<b>A61K 39/00</b> (2006.01)	P20231579	ANTI-CTLA-4 ANTITIJELA I POSTUPCI NJIHOVE UPOTREBE ANTI-CTLA-4 ANTIBODIES AND METHODS OF USE THEREOF
<b>A61K 39/00</b> (2006.01)	P20231630	CJEPIVA SA ČESTICAMA NALIK NA VIRUS (VLP) PSEĆEG PARVOVIRUSA (CPV) I NJIHOVE UPORABE CANINE PARVOVIRUS (CPV) VIRUS-LIKE PARTICLE (VLP) VACCINES AND USES THEREOF
<b>A61K 39/00</b> (2006.01)	P20231749	IMUNOGENI PRIPRAVAK IMMUNOGENIC COMPOSITION
<b>A61K 39/08</b> (2006.01)	P20231631	PRIPRAVCI KOJI SE ODOSE NA MUTANTNI TOKSIN IZ BAKTERIJE CLOSTRIDIUM DIFFICILE I ODGOVARAJUĆI POSTUPCI COMPOSITIONS RELATING TO A MUTANT CLOSTRIDIUM DIFFICILE TOXIN AND METHODS THEREOF
<b>A61K 39/08</b> (2006.01)	P20231749	IMUNOGENI PRIPRAVAK IMMUNOGENIC COMPOSITION
<b>A61K 39/12</b> (2006.01)	P20231581	PRIPRAVCI I POSTUPCI ZA KIMERNE KONSTRUKTE VIRUSA DENGGA GROZNICE U CJEPIVIMA COMPOSITIONS AND METHODS FOR DENGUE VIRUS CHIMERIC CONSTRUCTS IN VACCINES
<b>A61K 39/12</b> (2006.01)	P20231630	CJEPIVA SA ČESTICAMA NALIK NA VIRUS (VLP) PSEĆEG PARVOVIRUSA (CPV) I NJIHOVE UPORABE CANINE PARVOVIRUS (CPV) VIRUS-LIKE PARTICLE (VLP) VACCINES AND USES THEREOF
<b>A61K 39/135</b> (2006.01)	P20231630	CJEPIVA SA ČESTICAMA NALIK NA VIRUS (VLP) PSEĆEG PARVOVIRUSA (CPV) I NJIHOVE UPORABE CANINE PARVOVIRUS (CPV) VIRUS-LIKE PARTICLE (VLP) VACCINES AND USES THEREOF
<b>A61K 39/23</b> (2006.01)	P20231630	CJEPIVA SA ČESTICAMA NALIK NA VIRUS (VLP) PSEĆEG PARVOVIRUSA (CPV) I NJIHOVE UPORABE CANINE PARVOVIRUS (CPV) VIRUS-LIKE PARTICLE (VLP) VACCINES AND USES THEREOF
<b>A61K 39/395</b> (2006.01)	P20231542	KIMERNI ANTIGENSKI RECEPTORI KOJI CILJAJU BCMA I POSTUPCI NJIHOVE UPORABE CHIMERIC ANTIGEN RECEPTORS TARGETING BCMA AND METHODS OF USE THEREOF
<b>A61K 39/395</b> (2006.01)	P20231569	NOVA PROTUTIJELA PROTIV IL 13 I NJIHOVA UPOTREBA NOVEL ANTI-IL 13 ANTIBODIES AND USES THEREOF
<b>A61K 39/395</b> (2006.01)	P20231578	MOLEKULE PROTUTIJELA NA APRIL I NJIHOVE UPORABE ANTIBODY MOLECULES TO APRIL AND USES THEREOF
<b>A61K 39/395</b> (2006.01)	P20231664	NOVA ANTI-PD-L1 ANTITIJELA NOVEL ANTI-PD-L1 ANTIBODIES
<b>A61K 45/06</b> (2006.01)	P20231572	POSTUPCI I PRIPRAVCI ZA LIJEČENJE PRETILOSTI, SPREČAVANJE DOBIVANJA NA TEŽINI, PROMICANJE GUBITKA TEŽINE, PROMICANJE MRŠAVLJENJA, ILI LIJEČENJE ILI PREVENCIJU RAZVOJA DIJABETESA METHODS AND COMPOSITIONS FOR TREATING OBESITY, PREVENTING WEIGHT GAIN, PROMOTING WEIGHT LOSS, PROMOTING SLIMMING, OR TREATING OR PREVENTING THE DEVELOPMENT OF DIABETES
<b>A61K 45/06</b> (2006.01)	P20231608	DERIVATI PIRIDINIL SULFONAMIDA, NJIHOVI FARMACEUTSKI PRIPRAVCI I NJIHOVE UPORABE PYRIDINYL SULFONAMIDE DERIVATIVES, PHARMACEUTICAL COMPOSITIONS AND USES THEREOF
<b>A61K 47/02</b> (2006.01)	P20231692	POSTUPAK ZA SUZBIJANJE GORČINE DERIVATA KINOLINA METHOD FOR SUPPRESSING BITTERNESS OF QUINOLINE DERIVATIVE
<b>A61K 47/02</b> (2006.01)	P20231729	KOMBINIRANA TERAPIJA ZA KOPB COMBINATION THERAPY FOR COPD
<b>A61K 47/10</b> (2017.01)	P20231729	KOMBINIRANA TERAPIJA ZA KOPB COMBINATION THERAPY FOR COPD
<b>A61K 47/18</b> (2017.01)	P20231716	PRIPRAVCI INHIBITORA DOPA DEKARBOKSILAZE DOPA DECARBOXYLASE INHIBITOR COMPOSITIONS
<b>A61K 47/20</b> (2006.01)	P20231716	PRIPRAVCI INHIBITORA DOPA DEKARBOKSILAZE DOPA DECARBOXYLASE INHIBITOR COMPOSITIONS
<b>A61K 47/22</b> (2006.01)	P20231716	PRIPRAVCI INHIBITORA DOPA DEKARBOKSILAZE DOPA DECARBOXYLASE INHIBITOR COMPOSITIONS
<b>A61K 47/26</b> (2006.01)	P20231591	SOLUBILIZAT S KURKUMINOM I BAREM JEDNOM DRUGOM AKTIVNOM TVARI SOLUBILISATE WITH CURCUMIN AND AT LEAST ONE OTHER ACTIVE SUBSTANCE
<b>A61K 47/26</b> (2006.01)	P20231621	FORMULACIJE CIKLOSPORINA ZA UPOTREBU U PREVENCIJI ILI LIJEČENJU PLUČNOG KRONIČNOG ODBACIVANJA TRANSPLANTANTA CYCLOSPORINE FORMULATIONS FOR USE IN THE PREVENTION OR TREATMENT OF PULMONARY CHRONIC GRAFT REJECTION

MKP (51)	Broj patenta (11)	Naziv izuma (54)
<b>A61K 47/32</b> (2006.01)	P20231642	KONJUGATI POLIMER-LIJEK KOJI SE MOGU CIJEPATI CLEAVABLE POLYMER DRUG CONJUGATES
<b>A61K 47/32</b> (2006.01)	P20231706	INTRANAZALNI PRIPRAVAK KOJI SADRŽI BETAHISTIN INTRANASAL COMPOSITION COMPRISING BETAHISTINE
<b>A61K 47/34</b> (2017.01)	P20231667	FARMACEUTSKI PRIPRAVAK PHARMACEUTICAL COMPOSITION
<b>A61K 47/60</b> (2017.01)	P20231732	REŽIM DOZIRANJA PEGILIRANOG INTERFERONA DOSAGE REGIMEN FOR PEGYLATED INTERFERON
<b>A61K 47/68</b> (2017.01)	P20231609	KONJUGATI LIJEKA KOJI SADRŽE ANTITIJELA PROTIV KLAUDINA 18.2 DRUG CONJUGATES COMPRISING ANTIBODIES AGAINST CLAUDIN 18.2
<b>A61K 8/37</b> (2006.01)	P20231629	PRIPRAVCI ZA LIJEČENJE OPADANJA KOSE COMPOSITIONS FOR THE TREATMENT OF HAIR LOSS
<b>A61K 8/49</b> (2006.01)	P20231629	PRIPRAVCI ZA LIJEČENJE OPADANJA KOSE COMPOSITIONS FOR THE TREATMENT OF HAIR LOSS
<b>A61K 8/64</b> (2006.01)	P20231629	PRIPRAVCI ZA LIJEČENJE OPADANJA KOSE COMPOSITIONS FOR THE TREATMENT OF HAIR LOSS
<b>A61K 9/00</b> (2006.01)	P20231621	FORMULACIJE CIKLOSPORINA ZA UPOTREBU U PREVENCIJI ILI LIJEČENJU PLUĆNOG KRONIČNOG ODBACIVANJA TRANSPLANTANTA CYCLOSPORINE FORMULATIONS FOR USE IN THE PREVENTION OR TREATMENT OF PULMONARY CHRONIC GRAFT REJECTION
<b>A61K 9/00</b> (2006.01)	P20231667	FARMACEUTSKI PRIPRAVAK PHARMACEUTICAL COMPOSITION
<b>A61K 9/00</b> (2006.01)	P20231716	PRIPRAVCI INHIBITORA DOPA DEKARBOKSILAZE DOPA DECARBOXYLASE INHIBITOR COMPOSITIONS
<b>A61K 9/00</b> (2006.01)	P20231729	KOMBINIRANA TERAPIJA ZA KOPB COMBINATION THERAPY FOR COPD
<b>A61K 9/08</b> (2006.01)	P20231653	STABILNI FARMACEUTSKI SASTAVI ROPINIROLA STABLE PHARMACEUTICAL COMPOSITIONS OF ROPINIROLE
<b>A61K 9/08</b> (2006.01)	P20231694	SGLT-2 INHIBITOR ZA UPORABU U LIJEČENJU METABOLIČKOG POREMEĆAJA KOD ŽIVOTINJA IZ PORODICE MAČAKA AN SGLT-2 INHIBITOR FOR USE IN THE TREATMENT OF A METABOLIC DISORDER IN FELINE ANIMALS
<b>A61K 9/08</b> (2006.01)	P20231706	INTRANAZALNI PRIPRAVAK KOJI SADRŽI BETAHISTIN INTRANASAL COMPOSITION COMPRISING BETAHISTINE
<b>A61K 9/10</b> (2006.01)	P20231692	POSTUPAK ZA SUZBIJANJE GORČINE DERIVATA KINOLINA METHOD FOR SUPPRESSING BITTERNESS OF QUINOLINE DERIVATIVE
<b>A61K 9/107</b> (2006.01)	P20231591	SOLUBILIZAT S KURKUMINOM I BAREM JEDNOM DRUGOM AKTIVNOM TVARI SOLUBILISATE WITH CURCUMIN AND AT LEAST ONE OTHER ACTIVE SUBSTANCE
<b>A61K 9/107</b> (2006.01)	P20231641	FARMACEUTSKI PRIPRAVAK KOJI SADRŽI MITOTAN ZA ORALNU PRIMJENU ZA LIJEČENJE ADRENOKORTIKALNOG KARCINOMA I CUSHINGOVOG SINDROMA PHARMACEUTICAL COMPOSITION COMPRISING MITOTANE FOR ORAL ADMINISTRATION FOR USE IN THE TREATMENT OF ADRENOCORTICAL CARCINOMA AND CUSHING- SYNDROME
<b>A61K 9/127</b> (2006.01)	P20231621	FORMULACIJE CIKLOSPORINA ZA UPOTREBU U PREVENCIJI ILI LIJEČENJU PLUĆNOG KRONIČNOG ODBACIVANJA TRANSPLANTANTA CYCLOSPORINE FORMULATIONS FOR USE IN THE PREVENTION OR TREATMENT OF PULMONARY CHRONIC GRAFT REJECTION
<b>A61K 9/14</b> (2006.01)	P20231641	FARMACEUTSKI PRIPRAVAK KOJI SADRŽI MITOTAN ZA ORALNU PRIMJENU ZA LIJEČENJE ADRENOKORTIKALNOG KARCINOMA I CUSHINGOVOG SINDROMA PHARMACEUTICAL COMPOSITION COMPRISING MITOTANE FOR ORAL ADMINISTRATION FOR USE IN THE TREATMENT OF ADRENOCORTICAL CARCINOMA AND CUSHING- SYNDROME
<b>A61K 9/14</b> (2006.01)	P20231748	FARMACEUTSKA FORMULACIJA PHARMACEUTICAL FORMULATION
<b>A61K 9/16</b> (2006.01)	P20231548	FARMACEUTSKI PRIPRAVAK PHARMACEUTICAL PREPARATION
<b>A61K 9/16</b> (2006.01)	P20231641	FARMACEUTSKI PRIPRAVAK KOJI SADRŽI MITOTAN ZA ORALNU PRIMJENU ZA LIJEČENJE ADRENOKORTIKALNOG KARCINOMA I CUSHINGOVOG SINDROMA PHARMACEUTICAL COMPOSITION COMPRISING MITOTANE FOR ORAL ADMINISTRATION FOR USE IN THE TREATMENT OF ADRENOCORTICAL CARCINOMA AND CUSHING- SYNDROME
<b>A61K 9/19</b> (2006.01)	P20231621	FORMULACIJE CIKLOSPORINA ZA UPOTREBU U PREVENCIJI ILI LIJEČENJU PLUĆNOG KRONIČNOG ODBACIVANJA TRANSPLANTANTA CYCLOSPORINE FORMULATIONS FOR USE IN THE PREVENTION OR TREATMENT OF PULMONARY CHRONIC GRAFT REJECTION
<b>A61K 9/20</b> (2006.01)	P20231548	FARMACEUTSKI PRIPRAVAK PHARMACEUTICAL PREPARATION
<b>A61K 9/20</b> (2006.01)	P20231613	PRIPRAVCI KOJI SADRŽE SREDSTVO ZA UNOŠENJE I NJIHOVA PRIPRAVA COMPOSITIONS COMPRISING A DELIVERY AGENT AND PREPARATION THEREOF
<b>A61K 9/20</b> (2006.01)	P20231670	FARMACEUTSKI PRIPRAVAK ZA ORALNU PRIMJENU KOJI SADRŽI DERIVAT AMINOPYRIMIDINA ILI NJEGOVU SOL PHARMACEUTICAL COMPOSITION FOR ORAL ADMINISTRATION COMPRISING AMINOPYRIMIDINE DERIVATIVE OR ITS SALT
<b>A61K 9/20</b> (2006.01)	P20231691	PRIPRAVAK ZA UPOTREBU U LIJEČENJU PROMJENA U CRIJEVIMA COMPOSITION FOR USE IN THE TREATMENT OF INTESTINAL ALTERATIONS



MKP (51)	Broj patenta (11)	Naziv izuma (54)
<b>A61K 9/20</b> (2006.01)	P20231748	FARMACEUTSKA FORMULACIJA PHARMACEUTICAL FORMULATION
<b>A61K 9/28</b> (2006.01)	P20231691	PRIPRAVAK ZA UPOTREBU U LIJEČENJU PROMJENA U CRIJEVIMA COMPOSITION FOR USE IN THE TREATMENT OF INTESTINAL ALTERATIONS
<b>A61K 9/48</b> (2006.01)	P20231548	FARMACEUTSKI PRIPRAVAK PHARMACEUTICAL PREPARATION
<b>A61M 11/04</b> (2006.01)	P20231605	PATRONA I POSTUPAK ISPARAVANJA U SUSTAVU PATRONA S DIFUZOROM CARTRIDGE AND METHOD FOR VAPORIZING IN A CARTRIDGE SYSTEM WITH DIFFUSER
<b>A61M 11/04</b> (2006.01)	P20231696	VAPORIZATOR VAPORIZER
<b>A61M 15/00</b> (2006.01)	P20231605	PATRONA I POSTUPAK ISPARAVANJA U SUSTAVU PATRONA S DIFUZOROM CARTRIDGE AND METHOD FOR VAPORIZING IN A CARTRIDGE SYSTEM WITH DIFFUSER
<b>A61M 15/06</b> (2006.01)	P20231605	PATRONA I POSTUPAK ISPARAVANJA U SUSTAVU PATRONA S DIFUZOROM CARTRIDGE AND METHOD FOR VAPORIZING IN A CARTRIDGE SYSTEM WITH DIFFUSER
<b>A61M 15/06</b> (2006.01)	P20231696	VAPORIZATOR VAPORIZER
<b>A61M 25/10</b> (2013.01)	P20231672	BALONSKI KATETER BALLOON CATHETER
<b>A61M 5/20</b> (2006.01)	P20231575	AUTOMATSKI SISTEM ZA UBRIZGAVANJE AUTOMATIC INJECTION SYSTEM
<b>A61M 5/28</b> (2006.01)	P20231575	AUTOMATSKI SISTEM ZA UBRIZGAVANJE AUTOMATIC INJECTION SYSTEM
<b>A61P 1/00</b> (2006.01)	P20231653	STABILNI FARMACEUTSKI SASTAVI ROPINIROLA STABLE PHARMACEUTICAL COMPOSITIONS OF ROPINIROLE
<b>A61P 1/00</b> (2006.01)	P20231691	PRIPRAVAK ZA UPOTREBU U LIJEČENJU PROMJENA U CRIJEVIMA COMPOSITION FOR USE IN THE TREATMENT OF INTESTINAL ALTERATIONS
<b>A61P 1/04</b> (2006.01)	P20231691	PRIPRAVAK ZA UPOTREBU U LIJEČENJU PROMJENA U CRIJEVIMA COMPOSITION FOR USE IN THE TREATMENT OF INTESTINAL ALTERATIONS
<b>A61P 11/00</b> (2006.01)	P20231579	ANTI-CTLA-4 ANTITIJELA I POSTUPCI NJIHOVE UPOTREBE ANTI-CTLA-4 ANTIBODIES AND METHODS OF USE THEREOF
<b>A61P 11/00</b> (2006.01)	P20231608	DERIVATI PIRIDINIL SULFONAMIDA, NJIHOVI FARMACEUTSKI PRIPRAVCI I NJIHOVE UPORABE PYRIDINYL SULFONAMIDE DERIVATIVES, PHARMACEUTICAL COMPOSITIONS AND USES THEREOF
<b>A61P 11/00</b> (2006.01)	P20231639	MODULACIJSKA SREDSTVA TRANSMEMBRANSKOG REGULATORA PROVODLJIVOSTI CISTIČNE FIBROZE CYSTIC FIBROSIS TRANSMEMBRANE CONDUCTANCE REGULATOR MODULATING AGENTS
<b>A61P 11/00</b> (2006.01)	P20231729	KOMBINIRANA TERAPIJA ZA KOPB COMBINATION THERAPY FOR COPD
<b>A61P 1/16</b> (2006.01)	P20231591	SOLUBILIZAT S KURKUMINOM I BAREM JEDNOM DRUGOM AKTIVNOM TVARI SOLUBILISATE WITH CURCUMIN AND AT LEAST ONE OTHER ACTIVE SUBSTANCE
<b>A61P 1/16</b> (2006.01)	P20231608	DERIVATI PIRIDINIL SULFONAMIDA, NJIHOVI FARMACEUTSKI PRIPRAVCI I NJIHOVE UPORABE PYRIDINYL SULFONAMIDE DERIVATIVES, PHARMACEUTICAL COMPOSITIONS AND USES THEREOF
<b>A61P 13/12</b> (2006.01)	P20231563	4-OKSO-3,4-DIHIDROTINO[3,4-D]PIRIDAZINSKI SPOJEVI KAO INHIBITORI ALDOSOREDUKTAZE I NAČINI NJIHOVE UPOTREBE 4-OXO-3,4-DIHYDROTHIENO[3,4-D]PYRIDAZINE COMPOUNDS AS ALDOSE REDUCTASE INHIBITORS AND METHODS OF USE THEREOF
<b>A61P 13/12</b> (2006.01)	P20231608	DERIVATI PIRIDINIL SULFONAMIDA, NJIHOVI FARMACEUTSKI PRIPRAVCI I NJIHOVE UPORABE PYRIDINYL SULFONAMIDE DERIVATIVES, PHARMACEUTICAL COMPOSITIONS AND USES THEREOF
<b>A61P 13/12</b> (2006.01)	P20231616	DERIVATI BENZAZEPINA BENZAZEPINE DERIVATIVES
<b>A61P 13/12</b> (2006.01)	P20231739	MOLEKULE ANTITIJELA VIRUSA ANTI-BK ANTI-BK VIRUS ANTIBODY MOLECULES
<b>A61P 15/00</b> (2006.01)	P20231537	DERIVATI TETRAHIDRONAFTALENA I TETRAHIDROIZOKINOLINA KAO DEGRADATORI ESTROGENSKIH RECEPTORA TETRAHYDRONAPHTHALENE AND TETRAHYDROISOQUINOLINE DERIVATIVES AS ESTROGEN RECEPTOR DEGRADERS
<b>A61P 15/00</b> (2006.01)	P20231735	LIJEČENJE SIMPTOMA IZAZVANIH MENSTRUALNIM CIKLUSOM TREATMENT OF MENSTRUAL CYCLE-INDUCED SYMPTOMS
<b>A61P 17/00</b> (2006.01)	P20231563	4-OKSO-3,4-DIHIDROTINO[3,4-D]PIRIDAZINSKI SPOJEVI KAO INHIBITORI ALDOSOREDUKTAZE I NAČINI NJIHOVE UPOTREBE 4-OXO-3,4-DIHYDROTHIENO[3,4-D]PYRIDAZINE COMPOUNDS AS ALDOSE REDUCTASE INHIBITORS AND METHODS OF USE THEREOF
<b>A61P 17/14</b> (2006.01)	P20231629	PRIPRAVCI ZA LIJEČENJE OPADANJA KOSE COMPOSITIONS FOR THE TREATMENT OF HAIR LOSS
<b>A61P 19/00</b> (2006.01)	P20231732	REŽIM DOZIRANJA PEGILIRANOG INTERFERONA DOSAGE REGIMEN FOR PEGYLATED INTERFERON
<b>A61P 19/04</b> (2006.01)	P20231732	REŽIM DOZIRANJA PEGILIRANOG INTERFERONA DOSAGE REGIMEN FOR PEGYLATED INTERFERON
<b>A61P 19/08</b> (2006.01)	P20231732	REŽIM DOZIRANJA PEGILIRANOG INTERFERONA DOSAGE REGIMEN FOR PEGYLATED INTERFERON

MKP (51)	Broj patenta (11)	Naziv izuma (54)
<b>A61P 25/00</b> (2006.01)	P20231568	NOVA TERAPIJSKA UPOTREBA H3-LIGANADA NEW THERAPEUTICAL USE OF H3-LIGANDS
<b>A61P 25/00</b> (2006.01)	P20231694	SGLT-2 INHIBITOR ZA UPORABU U LIJEČENJU METABOLIČKOG POREMEĆAJA KOD ŽIVOTINJA IZ PORODICE MAČAKA AN SGLT-2 INHIBITOR FOR USE IN THE TREATMENT OF A METABOLIC DISORDER IN FELINE ANIMALS
<b>A61P 25/00</b> (2006.01)	P20231697	KRISTALNI OBLIK MAGL INHIBITORA A CRYSTALLINE FORM OF A MAGL INHIBITOR
<b>A61P 25/00</b> (2006.01)	P20231735	LIJEČENJE SIMPTOMA IZAZVANIH MENSTRUALNIM CIKLUSOM TREATMENT OF MENSTRUAL CYCLE-INDUCED SYMPTOMS
<b>A61P 25/02</b> (2006.01)	P20231538	FARMACEUTSKI SPOJ, POSTUPAK ZA NJEGOVU IZRADU I UPORABA KAO LIJEKOVITOG SREDSTVA PHARMACEUTICAL COMPOUND, THE METHOD OF ITS MAKING AND USE AS MEDICINAL AGENT
<b>A61P 25/06</b> (2006.01)	P20231587	KRONIČNO NOĆNO DOZIRANJE LASMIDITANA RADI SPRJEČAVANJA MIGRENE CHRONIC NIGHTLY DOSING OF LASMIDITAN FOR MIGRAINE PREVENTION
<b>A61P 25/08</b> (2006.01)	P20231568	NOVA TERAPIJSKA UPOTREBA H3-LIGANADA NEW THERAPEUTICAL USE OF H3-LIGANDS
<b>A61P 25/16</b> (2006.01)	P20231568	NOVA TERAPIJSKA UPOTREBA H3-LIGANADA NEW THERAPEUTICAL USE OF H3-LIGANDS
<b>A61P 25/16</b> (2006.01)	P20231716	PRIPRAVCI INHIBITORA DOPA DEKARBOKSILAZE DOPA DECARBOXYLASE INHIBITOR COMPOSITIONS
<b>A61P 25/24</b> (2006.01)	P20231568	NOVA TERAPIJSKA UPOTREBA H3-LIGANADA NEW THERAPEUTICAL USE OF H3-LIGANDS
<b>A61P 25/28</b> (2006.01)	P20231547	POSTUPCI LIJEČENJA MULTIPLE SKLEROZE PRIMJENOM SPOJEVA PIRIMIDINA I PIRIDINA S AKTIVNOŠĆU INHIBICIJE BTK METHODS FOR TREATING MULTIPLE SCLEROSIS USING PYRIMIDINE AND PYRIDINE COMPOUNDS WITH BTK INHIBITORY ACTIVITY
<b>A61P 25/28</b> (2006.01)	P20231576	DERIVATI SULFOPROPANSKE KISELINE ZA LIJEČENJE NEURODEGENERATIVNIH POREMEĆAJA SULFOPROPANOIC ACID DERIVATIVES FOR TREATING NEURODEGENERATIVE DISORDERS
<b>A61P 25/28</b> (2006.01)	P20231584	POSTUPAK ZA PODRŠKU MEMORIJSKOJ FUNKCIJI I/ILI KOGNITIVNOJ FUNKCIJI METHOD FOR SUPPORTING MEMORY FUNCTION AND/OR COGNITIVE FUNCTION
<b>A61P 25/28</b> (2006.01)	P20231663	BICIKLIČKI DERIVATI HETEROARILA BICYCLIC HETEROARYL DERIVATIVES
<b>A61P 25/32</b> (2006.01)	P20231568	NOVA TERAPIJSKA UPOTREBA H3-LIGANADA NEW THERAPEUTICAL USE OF H3-LIGANDS
<b>A61P 27/00</b> (2006.01)	P20231608	DERIVATI PIRIDINIL SULFONAMIDA, NJIHOVI FARMACEUTSKI PRIPRAVCI I NJIHOVE UPORABE PYRIDINYL SULFONAMIDE DERIVATIVES, PHARMACEUTICAL COMPOSITIONS AND USES THEREOF
<b>A61P 27/16</b> (2006.01)	P20231706	INTRANAZALNI PRIPRAVAK KOJI SADRŽI BETAHISTIN INTRANASAL COMPOSITION COMPRISING BETAHISTINE
<b>A61P 29/00</b> (2006.01)	P20231690	SELEKTIVNI INHIBITORI NLRP3 INFLAMASOMA SELECTIVE INHIBITORS OF NLRP3 INFLAMMASOME
<b>A61P 29/00</b> (2006.01)	P20231694	SGLT-2 INHIBITOR ZA UPORABU U LIJEČENJU METABOLIČKOG POREMEĆAJA KOD ŽIVOTINJA IZ PORODICE MAČAKA AN SGLT-2 INHIBITOR FOR USE IN THE TREATMENT OF A METABOLIC DISORDER IN FELINE ANIMALS
<b>A61P 29/00</b> (2006.01)	P20231697	KRISTALNI OBLIK MAGL INHIBITORA A CRYSTALLINE FORM OF A MAGL INHIBITOR
<b>A61P 3/00</b> (2006.01)	P20231568	NOVA TERAPIJSKA UPOTREBA H3-LIGANADA NEW THERAPEUTICAL USE OF H3-LIGANDS
<b>A61P 3/00</b> (2006.01)	P20231613	PRIPRAVCI KOJI SADRŽE SREDSTVO ZA UNOŠENJE I NJIHOVA PRIPRAVA COMPOSITIONS COMPRISING A DELIVERY AGENT AND PREPARATION THEREOF
<b>A61P 3/00</b> (2006.01)	P20231694	SGLT-2 INHIBITOR ZA UPORABU U LIJEČENJU METABOLIČKOG POREMEĆAJA KOD ŽIVOTINJA IZ PORODICE MAČAKA AN SGLT-2 INHIBITOR FOR USE IN THE TREATMENT OF A METABOLIC DISORDER IN FELINE ANIMALS
<b>A61P 3/02</b> (2006.01)	P20231572	POSTUPCI I PRIPRAVCI ZA LIJEČENJE PRETILOSTI, SPREČAVANJE DOBIVANJA NA TEŽINI, PROMICANJE GUBITKA TEŽINE, PROMICANJE MRŠAVLJENJA, ILI LIJEČENJE ILI PREVENCIJU RAZVOJA DIJABETESA METHODS AND COMPOSITIONS FOR TREATING OBESITY, PREVENTING WEIGHT GAIN, PROMOTING WEIGHT LOSS, PROMOTING SLIMMING, OR TREATING OR PREVENTING THE DEVELOPMENT OF DIABETES
<b>A61P 3/02</b> (2006.01)	P20231584	POSTUPAK ZA PODRŠKU MEMORIJSKOJ FUNKCIJI I/ILI KOGNITIVNOJ FUNKCIJI METHOD FOR SUPPORTING MEMORY FUNCTION AND/OR COGNITIVE FUNCTION
<b>A61P 3/04</b> (2006.01)	P20231572	POSTUPCI I PRIPRAVCI ZA LIJEČENJE PRETILOSTI, SPREČAVANJE DOBIVANJA NA TEŽINI, PROMICANJE GUBITKA TEŽINE, PROMICANJE MRŠAVLJENJA, ILI LIJEČENJE ILI PREVENCIJU RAZVOJA DIJABETESA METHODS AND COMPOSITIONS FOR TREATING OBESITY, PREVENTING WEIGHT GAIN, PROMOTING WEIGHT LOSS, PROMOTING SLIMMING, OR TREATING OR PREVENTING THE DEVELOPMENT OF DIABETES
<b>A61P 3/04</b> (2006.01)	P20231591	SOLUBILIZAT S KURKUMINOM I BAREM JEDNOM DRUGOM AKTIVNOM TVARI SOLUBILISATE WITH CURCUMIN AND AT LEAST ONE OTHER ACTIVE SUBSTANCE

MKP (51)	Broj patenta (11)	Naziv izuma (54)
<b>A61P 3/04</b> (2006.01)	P20231613	PRIPRAVCI KOJI SADRŽE SREDSTVO ZA UNOŠENJE I NJIHOVA PRIPRAVA COMPOSITIONS COMPRISING A DELIVERY AGENT AND PREPARATION THEREOF
<b>A61P 3/04</b> (2006.01)	P20231661	ANTAGONISTI NK-3 RECEPTORA ZA TERAPIJSKO ILI KOZMETIČKO LIJEČENJE VIŠKA TJELESNE MASTI NK-3 RECEPTOR ANTAGONISTS FOR THERAPEUTIC OR COSMETIC TREATMENT OF EXCESS BODY FAT
<b>A61P 3/06</b> (2006.01)	P20231572	POSTUPCI I PRIPRAVCI ZA LIJEČENJE PRETILOSTI, SPREČAVANJE DOBIVANJA NA TEŽINI, PROMICANJE GUBITKA TEŽINE, PROMICANJE MRŠAVLJENJA, ILI LIJEČENJE ILI PREVENCIJU RAZVOJA DIJABETESA METHODS AND COMPOSITIONS FOR TREATING OBESITY, PREVENTING WEIGHT GAIN, PROMOTING WEIGHT LOSS, PROMOTING SLIMMING, OR TREATING OR PREVENTING THE DEVELOPMENT OF DIABETES
<b>A61P 3/06</b> (2006.01)	P20231591	SOLUBILIZAT S KURKUMINOM I BAREM JEDNOM DRUGOM AKTIVNOM TVARI SOLUBILISATE WITH CURCUMIN AND AT LEAST ONE OTHER ACTIVE SUBSTANCE
<b>A61P 3/08</b> (2006.01)	P20231572	POSTUPCI I PRIPRAVCI ZA LIJEČENJE PRETILOSTI, SPREČAVANJE DOBIVANJA NA TEŽINI, PROMICANJE GUBITKA TEŽINE, PROMICANJE MRŠAVLJENJA, ILI LIJEČENJE ILI PREVENCIJU RAZVOJA DIJABETESA METHODS AND COMPOSITIONS FOR TREATING OBESITY, PREVENTING WEIGHT GAIN, PROMOTING WEIGHT LOSS, PROMOTING SLIMMING, OR TREATING OR PREVENTING THE DEVELOPMENT OF DIABETES
<b>A61P 3/10</b> (2006.01)	P20231568	NOVA TERAPIJSKA UPOTREBA H3-LIGANADA NEW THERAPEUTICAL USE OF H3-LIGANDS
<b>A61P 3/10</b> (2006.01)	P20231572	POSTUPCI I PRIPRAVCI ZA LIJEČENJE PRETILOSTI, SPREČAVANJE DOBIVANJA NA TEŽINI, PROMICANJE GUBITKA TEŽINE, PROMICANJE MRŠAVLJENJA, ILI LIJEČENJE ILI PREVENCIJU RAZVOJA DIJABETESA METHODS AND COMPOSITIONS FOR TREATING OBESITY, PREVENTING WEIGHT GAIN, PROMOTING WEIGHT LOSS, PROMOTING SLIMMING, OR TREATING OR PREVENTING THE DEVELOPMENT OF DIABETES
<b>A61P 3/10</b> (2006.01)	P20231586	AGONISTI RECEPTORA GLUKAGONU SLIČNOG PEPTIDA 1 GLUCAGON-LIKE PEPTIDE 1 RECEPTOR AGONISTS
<b>A61P 3/10</b> (2006.01)	P20231591	SOLUBILIZAT S KURKUMINOM I BAREM JEDNOM DRUGOM AKTIVNOM TVARI SOLUBILISATE WITH CURCUMIN AND AT LEAST ONE OTHER ACTIVE SUBSTANCE
<b>A61P 3/10</b> (2006.01)	P20231613	PRIPRAVCI KOJI SADRŽE SREDSTVO ZA UNOŠENJE I NJIHOVA PRIPRAVA COMPOSITIONS COMPRISING A DELIVERY AGENT AND PREPARATION THEREOF
<b>A61P 3/10</b> (2006.01)	P20231694	SGLT-2 INHIBITOR ZA UPORABU U LIJEČENJU METABOLIČKOG POREMEĆAJA KOD ŽIVOTINJA IZ PORODICE MAČAKA AN SGLT-2 INHIBITOR FOR USE IN THE TREATMENT OF A METABOLIC DISORDER IN FELINE ANIMALS
<b>A61P 31/00</b> (2006.01)	P20231630	CJEPIVA SA ČESTICAMA NALIK NA VIRUS (VLP) PSEĆEG PARVOVIRUSA (CPV) I NJIHOVE UPORABE CANINE PARVOVIRUS (CPV) VIRUS-LIKE PARTICLE (VLP) VACCINES AND USES THEREOF
<b>A61P 31/00</b> (2006.01)	P20231732	REŽIM DOZIRANJA PEGILIRANOG INTERFERONA DOSAGE REGIMEN FOR PEGYLATED INTERFERON
<b>A61P 31/12</b> (2006.01)	P20231664	NOVA ANTI-PD-L1 ANTITIJELA NOVEL ANTI-PD-L1 ANTIBODIES
<b>A61P 31/12</b> (2006.01)	P20231739	MOLEKULE ANTITIJELA VIRUSA ANTI-BK ANTI-BK VIRUS ANTIBODY MOLECULES
<b>A61P 31/14</b> (2006.01)	P20231571	DERIVATI FENIL/PIRIDIL-NH-FENIL/PIRIDIL ZA LIJEČENJE INFEKCIJA RNA VIRUSOM PHENYL/PYRIDYL-N-PHENYL/PYRIDYL DERIVATIVES FOR TREATING RNA VIRUS INFECTION
<b>A61P 31/18</b> (2006.01)	P20231582	NOVI DERIVATI TRITERPENA KAO INHIBITORI HIV-A NOVEL TRITERPENE DERIVATIVES AS HIV INHIBITORS
<b>A61P 31/18</b> (2006.01)	P20231588	KOMBINACIJA KOJA SADRŽI STABILNI KRISTAL 4-OXSOKINOLINSKOG SPOJA COMBINATION COMPRISING A STABLE CRYSTAL OF A 4-OXSOKINOLINE COMPOUND
<b>A61P 31/18</b> (2006.01)	P20231654	SUPSTITUIRANI SPOJEVI PIRIDOTRIAZINA I NJIHOVE UPORABE SUBSTITUTED PYRIDOTRIAZINE COMPOUNDS AND USES THEREOF
<b>A61P 31/20</b> (2006.01)	P20231630	CJEPIVA SA ČESTICAMA NALIK NA VIRUS (VLP) PSEĆEG PARVOVIRUSA (CPV) I NJIHOVE UPORABE CANINE PARVOVIRUS (CPV) VIRUS-LIKE PARTICLE (VLP) VACCINES AND USES THEREOF
<b>A61P 31/20</b> (2006.01)	P20231739	MOLEKULE ANTITIJELA VIRUSA ANTI-BK ANTI-BK VIRUS ANTIBODY MOLECULES
<b>A61P 35/00</b> (2006.01)	P20231163	PROLIJEKOVI GLUTAMINSKIH ANALOGA PRODRUGS OF GLUTAMINE ANALOGS
<b>A61P 35/00</b> (2006.01)	P20231525	POSTUPCI I PRIPRAVCI ZA DIJAGNOZU I LIJEČENJE RAKA METHODS AND COMPOSITIONS FOR DIAGNOSIS AND TREATMENT OF CANCER
<b>A61P 35/00</b> (2006.01)	P20231542	KIMERNI ANTIGENSKI RECEPTORI KOJI CILJAJU BCMA I POSTUPCI NJIHOVE UPORABE CHIMERIC ANTIGEN RECEPTORS TARGETING BCMA AND METHODS OF USE THEREOF
<b>A61P 35/00</b> (2006.01)	P20231548	FARMACEUTSKI PRIPRAVAK PHARMACEUTICAL PREPARATION
<b>A61P 35/00</b> (2006.01)	P20231569	NOVA PROTUTIJELA PROTIV IL 13 I NJIHOVA UPOTREBA NOVEL ANTI-IL 13 ANTIBODIES AND USES THEREOF
<b>A61P 35/00</b> (2006.01)	P20231570	PEPTID ZA UPORABU U IMUNOTERAPIJI PROTIV NESITNOSTANIČNOG RAKA PLUĆA I SITNOSTANIČNOG RAKA PLUĆA PEPTIDE AND COMBINATION OF PEPTIDES FOR USE IN IMMUNOTHERAPY AGAINST NON- SMALL CELL LUNG CANCER AND OTHER CANCERS

MKP (51)	Broj patenta (11)	Naziv izuma (54)
<b>A61P 35/00</b> (2006.01)	P20231608	DERIVATI PIRIDINIL SULFONAMIDA, NJIHOVI FARMACEUTSKI PRIPRAVCI I NJIHOVE UPORABE PYRIDINYL SULFONAMIDE DERIVATIVES, PHARMACEUTICAL COMPOSITIONS AND USES THEREOF
<b>A61P 35/00</b> (2006.01)	P20231609	KONJUGATI LIJEKA KOJI SADRŽE ANTITIJELA PROTIV KLAUDINA 18.2 DRUG CONJUGATES COMPRISING ANTIBODIES AGAINST CLAUDIN 18.2
<b>A61P 35/00</b> (2006.01)	P20231614	SPOJEVI PIROLOTRIAZINA KAO TAM INHIBITORI PYRROLOTRIAZINE COMPOUNDS AS TAM INHIBITORS
<b>A61P 35/00</b> (2006.01)	P20231641	FARMACEUTSKI PRIPRAVAK KOJI SADRŽI MITOTAN ZA ORALNU PRIMJENU ZA LIJEČENJE ADRENOKORTIKALNOG KARCINOMA I CUSHINGOVOG SINDROMA PHARMACEUTICAL COMPOSITION COMPRISING MITOTANE FOR ORAL ADMINISTRATION FOR USE IN THE TREATMENT OF ADRENOCORTICAL CARCINOMA AND CUSHING-SYNDROME
<b>A61P 35/00</b> (2006.01)	P20231642	KONJUGATI POLIMER-LIJEK KOJI SE MOGU CIJEPATI CLEAVABLE POLYMER DRUG CONJUGATES
<b>A61P 35/00</b> (2006.01)	P20231664	NOVA ANTI-PD-L1 ANTITIJELA NOVEL ANTI-PD-L1 ANTIBODIES
<b>A61P 35/00</b> (2006.01)	P20231673	INHIBITORI PRMT5 PRMT5 INHIBITORS
<b>A61P 35/00</b> (2006.01)	P20231692	POSTUPAK ZA SUZBIJANJE GORČINE DERIVATA KINOLINA METHOD FOR SUPPRESSING BITTERNESS OF QUINOLINE DERIVATIVE
<b>A61P 35/00</b> (2006.01)	P20231707	ŽIVOTINJE KOJE NISU LJUDI, KOJE SADRŽE HUMANIZIRANI GEN IZ DIFERENCIJACIJSKE SKUPINE 47 NON-HUMAN ANIMALS HAVING A HUMANIZED CLUSTER OF DIFFERENTIATION 47 GENE
<b>A61P 35/00</b> (2006.01)	P20231732	REŽIM DOZIRANJA PEGILIRANOG INTERFERONA DOSAGE REGIMEN FOR PEGYLATED INTERFERON
<b>A61P 35/00</b> (2006.01)	P20231734	TRICIKLIČKI AKR1C3 OVISNI KARS INHIBITORI TRICYCLIC AKR1C3 DEPENDENT KARS INHIBITORS
<b>A61P 35/00</b> (2006.01)	P20231748	FARMACEUTSKA FORMULACIJA PHARMACEUTICAL FORMULATION
<b>A61P 35/02</b> (2006.01)	P20231542	KIMERNI ANTIGENSKI RECEPTORI KOJI CILJAJU BCMA I POSTUPCI NJIHOVE UPORABE CHIMERIC ANTIGEN RECEPTORS TARGETING BCMA AND METHODS OF USE THEREOF
<b>A61P 35/02</b> (2006.01)	P20231732	REŽIM DOZIRANJA PEGILIRANOG INTERFERONA DOSAGE REGIMEN FOR PEGYLATED INTERFERON
<b>A61P 35/04</b> (2006.01)	P20231525	POSTUPCI I PRIPRAVCI ZA DIJAGNOZU I LIJEČENJE RAKA METHODS AND COMPOSITIONS FOR DIAGNOSIS AND TREATMENT OF CANCER
<b>A61P 35/04</b> (2006.01)	P20231579	ANTI-CTLA-4 ANTITIJELA I POSTUPCI NJIHOVE UPOTREBE ANTI-CTLA-4 ANTIBODIES AND METHODS OF USE THEREOF
<b>A61P 37/00</b> (2006.01)	P20231690	SELEKTIVNI INHIBITORI NLRP3 INFLAMASOMA SELECTIVE INHIBITORS OF NLRP3 INFLAMMASOME
<b>A61P 37/04</b> (2006.01)	P20231525	POSTUPCI I PRIPRAVCI ZA DIJAGNOZU I LIJEČENJE RAKA METHODS AND COMPOSITIONS FOR DIAGNOSIS AND TREATMENT OF CANCER
<b>A61P 37/04</b> (2006.01)	P20231664	NOVA ANTI-PD-L1 ANTITIJELA NOVEL ANTI-PD-L1 ANTIBODIES
<b>A61P 37/06</b> (2006.01)	P20231621	FORMULACIJE CIKLOSPORINA ZA UPOTREBU U PREVENCIJI ILI LIJEČENJU PLUĆNOG KRONIČNOG ODBACIVANJA TRANSPLANTANTA CYCLOSPORINE FORMULATIONS FOR USE IN THE PREVENTION OR TREATMENT OF PULMONARY CHRONIC GRAFT REJECTION
<b>A61P 37/06</b> (2006.01)	P20231739	MOLEKULE ANTITIJELA VIRUSA ANTI-BK ANTI-BK VIRUS ANTIBODY MOLECULES
<b>A61P 43/00</b> (2006.01)	P20231568	NOVA TERAPIJSKA UPOTREBA H3-LIGANADA NEW THERAPEUTICAL USE OF H3-LIGANDS
<b>A61P 43/00</b> (2006.01)	P20231692	POSTUPAK ZA SUZBIJANJE GORČINE DERIVATA KINOLINA METHOD FOR SUPPRESSING BITTERNESS OF QUINOLINE DERIVATIVE
<b>A61P 43/00</b> (2006.01)	P20231694	SGLT-2 INHIBITOR ZA UPORABU U LIJEČENJU METABOLIČKOG POREMEĆAJA KOD ŽIVOTINJA IZ PORODICE MAČAKA AN SGLT-2 INHIBITOR FOR USE IN THE TREATMENT OF A METABOLIC DISORDER IN FELINE ANIMALS
<b>A61P 43/00</b> (2006.01)	P20231729	KOMBINIRANA TERAPIJA ZA KOPB COMBINATION THERAPY FOR COPD
<b>A61P 5/50</b> (2006.01)	P20231694	SGLT-2 INHIBITOR ZA UPORABU U LIJEČENJU METABOLIČKOG POREMEĆAJA KOD ŽIVOTINJA IZ PORODICE MAČAKA AN SGLT-2 INHIBITOR FOR USE IN THE TREATMENT OF A METABOLIC DISORDER IN FELINE ANIMALS
<b>A61P 7/00</b> (2006.01)	P20231542	KIMERNI ANTIGENSKI RECEPTORI KOJI CILJAJU BCMA I POSTUPCI NJIHOVE UPORABE CHIMERIC ANTIGEN RECEPTORS TARGETING BCMA AND METHODS OF USE THEREOF
<b>A61P 7/00</b> (2006.01)	P20231732	REŽIM DOZIRANJA PEGILIRANOG INTERFERONA DOSAGE REGIMEN FOR PEGYLATED INTERFERON
<b>A61P 9/00</b> (2006.01)	P20231608	DERIVATI PIRIDINIL SULFONAMIDA, NJIHOVI FARMACEUTSKI PRIPRAVCI I NJIHOVE UPORABE PYRIDINYL SULFONAMIDE DERIVATIVES, PHARMACEUTICAL COMPOSITIONS AND USES THEREOF
<b>A61P 9/00</b> (2006.01)	P20231676	ESTERI AMARUCIAKSANTINA A I NJIHOVA UPOTREBA AMAROUCIAXANTHIN A ESTERS AND USES THEREOF

MKP (51)	Broj patenta (11)	Naziv izuma (54)
<b>A61P 9/10</b> (2006.01)	P20231563	4-OKSO-3,4-DIHDROTINO[3,4-D]PIRIDAZINSKI SPOJEVI KAO INHIBITORI ALDOSOREDUKTAZE I NAČINI NJIHOVE UPOTREBE 4-OXO-3,4-DIHYDROTHIENO[3,4-D]PYRIDAZINE COMPOUNDS AS ALDOSE REDUCTASE INHIBITORS AND METHODS OF USE THEREOF
<b>A61P 9/10</b> (2006.01)	P20231694	SGLT-2 INHIBITOR ZA UPORABU U LIJEČENJU METABOLIČKOG POREMEĆAJA KOD ŽIVOTINJA IZ PORODICE MAČAKA AN SGLT-2 INHIBITOR FOR USE IN THE TREATMENT OF A METABOLIC DISORDER IN FELINE ANIMALS
<b>A61Q 19/08</b> (2006.01)	P20231563	4-OKSO-3,4-DIHDROTINO[3,4-D]PIRIDAZINSKI SPOJEVI KAO INHIBITORI ALDOSOREDUKTAZE I NAČINI NJIHOVE UPOTREBE 4-OXO-3,4-DIHYDROTHIENO[3,4-D]PYRIDAZINE COMPOUNDS AS ALDOSE REDUCTASE INHIBITORS AND METHODS OF USE THEREOF
<b>A61Q 7/00</b> (2006.01)	P20231629	PRIPRAVCI ZA LIJEČENJE OPADANJA KOSE COMPOSITIONS FOR THE TREATMENT OF HAIR LOSS
<b>A63B 71/02</b> (2006.01)	P20231712	SKLOP ZA ŠIPKU ZA PLESNE VJEŽBE ASSEMBLY FOR A DANCE EXERCISE POLE
<b>A63F 1/06</b> (2006.01)	P20231674	CIPELA DJELITELJA KARATA S GURAČEM A CARD DEALING SHOE WITH A PUSHER
<b>A63F 1/14</b> (2006.01)	P20231674	CIPELA DJELITELJA KARATA S GURAČEM A CARD DEALING SHOE WITH A PUSHER
<b>B01D 15/36</b> (2006.01)	P20231544	NABIJENA DUBINSKA FILTRACIJA PROTEINA KOJI VEŽU ANTIGENE CHARGED DEPTH FILTRATION OF ANTIGEN-BINDING PROTEINS
<b>B01D 15/38</b> (2006.01)	P20231544	NABIJENA DUBINSKA FILTRACIJA PROTEINA KOJI VEŽU ANTIGENE CHARGED DEPTH FILTRATION OF ANTIGEN-BINDING PROTEINS
<b>B01F 23/00</b> (2022.01)	P20231624	ADAPTER GLAVE ZA PUNJENJE ZA STROJ ZA KARBONIZACIJU FILLING HEAD ADAPTER FOR CARBONATION MACHINE
<b>B02C 18/14</b> (2006.01)	P20231625	UREĐAJ ZA USITNJAVANJE MATERIJALA UKLJUČUJUĆI STACIONARNO KUĆIŠTE I METODU ZA PROIZVODNJU STACIONARNOG KUĆIŠTA AN APPARATUS FOR PULVERIZING MATERIAL INCLUDING A STATIONARY HOUSING AND A METHOD FOR PRODUCING THE STATIONARY HOUSING
<b>B02C 18/18</b> (2006.01)	P20231625	UREĐAJ ZA USITNJAVANJE MATERIJALA UKLJUČUJUĆI STACIONARNO KUĆIŠTE I METODU ZA PROIZVODNJU STACIONARNOG KUĆIŠTA AN APPARATUS FOR PULVERIZING MATERIAL INCLUDING A STATIONARY HOUSING AND A METHOD FOR PRODUCING THE STATIONARY HOUSING
<b>B02C 18/20</b> (2006.01)	P20231625	UREĐAJ ZA USITNJAVANJE MATERIJALA UKLJUČUJUĆI STACIONARNO KUĆIŠTE I METODU ZA PROIZVODNJU STACIONARNOG KUĆIŠTA AN APPARATUS FOR PULVERIZING MATERIAL INCLUDING A STATIONARY HOUSING AND A METHOD FOR PRODUCING THE STATIONARY HOUSING
<b>B05B 16/00</b> (2018.01)	P20231658	POSTROJENJE, MODUL ZA OBRADU I POSTUPAK ZA OBRADU PREDMETA INSTALLATION, TREATMENT MODULE AND METHOD FOR THE TREATMENT OF OBJECTS
<b>B05B 16/20</b> (2018.01)	P20231658	POSTROJENJE, MODUL ZA OBRADU I POSTUPAK ZA OBRADU PREDMETA INSTALLATION, TREATMENT MODULE AND METHOD FOR THE TREATMENT OF OBJECTS
<b>B21D 39/04</b> (2006.01)	P20231700	NAPRAVA ZA HVATANJE PREDMETA I ALAT ZA PRIČVRŠĆIVANJE CIJEVNOG SPOJA OBJECT GRASPING DEVICE AND SWAGING-TYPE TUBE FITTING FASTENING TOOL USING SAME
<b>B23D 61/02</b> (2006.01)	P20231625	UREĐAJ ZA USITNJAVANJE MATERIJALA UKLJUČUJUĆI STACIONARNO KUĆIŠTE I METODU ZA PROIZVODNJU STACIONARNOG KUĆIŠTA AN APPARATUS FOR PULVERIZING MATERIAL INCLUDING A STATIONARY HOUSING AND A METHOD FOR PRODUCING THE STATIONARY HOUSING
<b>B23H 11/00</b> (2006.01)	P20231545	POSTUPAK I UREĐAJ ZA PROIZVODNJU METALNE KOMPONENTE, NAROČITO KOMPONENTE LOPATICE TURBOSTROJA METHOD AND APPARATUS FOR PRODUCING A METAL COMPONENT, IN PARTICULAR A BLADE COMPONENT OF A TURBOMACHINE
<b>B23H 3/04</b> (2006.01)	P20231545	POSTUPAK I UREĐAJ ZA PROIZVODNJU METALNE KOMPONENTE, NAROČITO KOMPONENTE LOPATICE TURBOSTROJA METHOD AND APPARATUS FOR PRODUCING A METAL COMPONENT, IN PARTICULAR A BLADE COMPONENT OF A TURBOMACHINE
<b>B23H 9/10</b> (2006.01)	P20231545	POSTUPAK I UREĐAJ ZA PROIZVODNJU METALNE KOMPONENTE, NAROČITO KOMPONENTE LOPATICE TURBOSTROJA METHOD AND APPARATUS FOR PRODUCING A METAL COMPONENT, IN PARTICULAR A BLADE COMPONENT OF A TURBOMACHINE
<b>B25B 27/02</b> (2006.01)	P20231700	NAPRAVA ZA HVATANJE PREDMETA I ALAT ZA PRIČVRŠĆIVANJE CIJEVNOG SPOJA OBJECT GRASPING DEVICE AND SWAGING-TYPE TUBE FITTING FASTENING TOOL USING SAME
<b>B25B 27/10</b> (2006.01)	P20231700	NAPRAVA ZA HVATANJE PREDMETA I ALAT ZA PRIČVRŠĆIVANJE CIJEVNOG SPOJA OBJECT GRASPING DEVICE AND SWAGING-TYPE TUBE FITTING FASTENING TOOL USING SAME
<b>B25B 5/14</b> (2006.01)	P20231700	NAPRAVA ZA HVATANJE PREDMETA I ALAT ZA PRIČVRŠĆIVANJE CIJEVNOG SPOJA OBJECT GRASPING DEVICE AND SWAGING-TYPE TUBE FITTING FASTENING TOOL USING SAME
<b>B28B 1/00</b> (2006.01)	P20231554	BETONSKI ELEMENT I POSTUPAK NJEGOVE PROIZVODNJE CONCRETE ELEMENT AND METHOD FOR THE PRODUCTION THEREOF
<b>B28B 13/02</b> (2006.01)	P20231554	BETONSKI ELEMENT I POSTUPAK NJEGOVE PROIZVODNJE CONCRETE ELEMENT AND METHOD FOR THE PRODUCTION THEREOF
<b>B28B 17/02</b> (2006.01)	P20231680	POSTUPAK I POSTROJENJE ZA PROIZVODNJU CRIJEPA KAO I CRIJEP METHOD AND SYSTEM FOR PRODUCING A ROOF TILE, AND ROOF TILE

MKP (51)	Broj patenta (11)	Naziv izuma (54)
<b>B28B 3/02</b> (2006.01)	P20231680	POSTUPAK I POSTROJENJE ZA PROIZVODNJU CRIJEP KAO I CRIJEP METHOD AND SYSTEM FOR PRODUCING A ROOF TILE, AND ROOF TILE
<b>B28C 1/18</b> (2006.01)	P20231680	POSTUPAK I POSTROJENJE ZA PROIZVODNJU CRIJEP KAO I CRIJEP METHOD AND SYSTEM FOR PRODUCING A ROOF TILE, AND ROOF TILE
<b>B29D 99/00</b> (2010.01)	P20231647	STRUKTURA RUKAVICE GLOVE STRUCTURE
<b>B32B 15/082</b> (2006.01)	P20231600	KOMPOZITNI ELEMENT KOJI SADRŽI POKROVNI SLOJ FURNIRA COMPOSITE ELEMENT WITH A COVERING LAYER OF VENEER
<b>B32B 15/095</b> (2006.01)	P20231600	KOMPOZITNI ELEMENT KOJI SADRŽI POKROVNI SLOJ FURNIRA COMPOSITE ELEMENT WITH A COVERING LAYER OF VENEER
<b>B32B 15/098</b> (2006.01)	P20231600	KOMPOZITNI ELEMENT KOJI SADRŽI POKROVNI SLOJ FURNIRA COMPOSITE ELEMENT WITH A COVERING LAYER OF VENEER
<b>B32B 15/10</b> (2006.01)	P20231600	KOMPOZITNI ELEMENT KOJI SADRŽI POKROVNI SLOJ FURNIRA COMPOSITE ELEMENT WITH A COVERING LAYER OF VENEER
<b>B32B 15/20</b> (2006.01)	P20231600	KOMPOZITNI ELEMENT KOJI SADRŽI POKROVNI SLOJ FURNIRA COMPOSITE ELEMENT WITH A COVERING LAYER OF VENEER
<b>B32B 17/06</b> (2006.01)	P20231600	KOMPOZITNI ELEMENT KOJI SADRŽI POKROVNI SLOJ FURNIRA COMPOSITE ELEMENT WITH A COVERING LAYER OF VENEER
<b>B32B 21/08</b> (2006.01)	P20231600	KOMPOZITNI ELEMENT KOJI SADRŽI POKROVNI SLOJ FURNIRA COMPOSITE ELEMENT WITH A COVERING LAYER OF VENEER
<b>B32B 21/10</b> (2006.01)	P20231600	KOMPOZITNI ELEMENT KOJI SADRŽI POKROVNI SLOJ FURNIRA COMPOSITE ELEMENT WITH A COVERING LAYER OF VENEER
<b>B32B 21/14</b> (2006.01)	P20231600	KOMPOZITNI ELEMENT KOJI SADRŽI POKROVNI SLOJ FURNIRA COMPOSITE ELEMENT WITH A COVERING LAYER OF VENEER
<b>B32B 3/12</b> (2006.01)	P20231600	KOMPOZITNI ELEMENT KOJI SADRŽI POKROVNI SLOJ FURNIRA COMPOSITE ELEMENT WITH A COVERING LAYER OF VENEER
<b>B32B 37/12</b> (2006.01)	P20231600	KOMPOZITNI ELEMENT KOJI SADRŽI POKROVNI SLOJ FURNIRA COMPOSITE ELEMENT WITH A COVERING LAYER OF VENEER
<b>B32B 38/08</b> (2006.01)	P20231600	KOMPOZITNI ELEMENT KOJI SADRŽI POKROVNI SLOJ FURNIRA COMPOSITE ELEMENT WITH A COVERING LAYER OF VENEER
<b>B32B 7/12</b> (2006.01)	P20231600	KOMPOZITNI ELEMENT KOJI SADRŽI POKROVNI SLOJ FURNIRA COMPOSITE ELEMENT WITH A COVERING LAYER OF VENEER
<b>B41J 2/045</b> (2006.01)	P20231660	KOMPONENTA ZA ISPIS S NIZOM MEMORIJE S POMOĆU ISPREKIDANOG SIGNALA SATA PRINT COMPONENT WITH MEMORY ARRAY USING INTERMITTENT CLOCK SIGNAL
<b>B44B 5/00</b> (2006.01)	P20231738	UREĐAJ ZA UTISKIVANJE FILMA DEVICE FOR EMBOSsing FILMS
<b>B44B 5/02</b> (2006.01)	P20231738	UREĐAJ ZA UTISKIVANJE FILMA DEVICE FOR EMBOSsing FILMS
<b>B44C 5/04</b> (2006.01)	P20231688	PVC PLASTIČNA PLOČA PVC PLASTIC PANEL
<b>B60H 1/00</b> (2006.01)	P20231723	SUSTAV REGULACIJE TOPLINE I ELEKTRIČNO VOZILO KOJE UKLJUČUJE SUSTAV REGULACIJE TOPLINE THERMAL MANAGEMENT SYSTEM AND AN ELECTRIC VEHICLE INCLUDING THE THERMAL MANAGEMENT SYSTEM
<b>B60H 1/14</b> (2006.01)	P20231723	SUSTAV REGULACIJE TOPLINE I ELEKTRIČNO VOZILO KOJE UKLJUČUJE SUSTAV REGULACIJE TOPLINE THERMAL MANAGEMENT SYSTEM AND AN ELECTRIC VEHICLE INCLUDING THE THERMAL MANAGEMENT SYSTEM
<b>B60H 1/22</b> (2006.01)	P20231723	SUSTAV REGULACIJE TOPLINE I ELEKTRIČNO VOZILO KOJE UKLJUČUJE SUSTAV REGULACIJE TOPLINE THERMAL MANAGEMENT SYSTEM AND AN ELECTRIC VEHICLE INCLUDING THE THERMAL MANAGEMENT SYSTEM
<b>B63B 15/00</b> (2006.01)	P20231603	OKOMITA KOMPONENTA SNASTI, OSOBITO JARBOL PLOVILA, I POSTUPAK NJEGOVE PROIZVODNJE STANDING RIGGING COMPONENT, IN PARTICULAR THE MAST OF A VESSEL, AND THE METHOD OF ITS MANUFACTURE
<b>B64C 39/02</b> (2023.01)	P20231656	SUSTAV ZA PROVJERU CJELOVITOSTI BESPILOTNIH LETJELICA SYSTEM FOR VERIFICATION OF INTEGRITY OF UNMANNED AERIAL VEHICLES
<b>B64D 11/02</b> (2006.01)	P20231589	PALUBNA TOALETNA KABINA ON-BOARD TOILET CABIN
<b>B65B 47/00</b> (2006.01)	P20231651	POSTUPAK PROIZVODNJE SPREMNIKA ZA PREHRAMBENE PROIZVODE METHOD TO MANUFACTURE A CONTAINER FOR FOOD PRODUCTS
<b>B65B 51/02</b> (2006.01)	P20231651	POSTUPAK PROIZVODNJE SPREMNIKA ZA PREHRAMBENE PROIZVODE METHOD TO MANUFACTURE A CONTAINER FOR FOOD PRODUCTS
<b>B65B 55/24</b> (2006.01)	P20231651	POSTUPAK PROIZVODNJE SPREMNIKA ZA PREHRAMBENE PROIZVODE METHOD TO MANUFACTURE A CONTAINER FOR FOOD PRODUCTS
<b>B65B 57/06</b> (2006.01)	P20231651	POSTUPAK PROIZVODNJE SPREMNIKA ZA PREHRAMBENE PROIZVODE METHOD TO MANUFACTURE A CONTAINER FOR FOOD PRODUCTS
<b>B65B 61/00</b> (2006.01)	P20231651	POSTUPAK PROIZVODNJE SPREMNIKA ZA PREHRAMBENE PROIZVODE METHOD TO MANUFACTURE A CONTAINER FOR FOOD PRODUCTS
<b>B65B 7/16</b> (2006.01)	P20231651	POSTUPAK PROIZVODNJE SPREMNIKA ZA PREHRAMBENE PROIZVODE METHOD TO MANUFACTURE A CONTAINER FOR FOOD PRODUCTS
<b>B65B 7/28</b> (2006.01)	P20231651	POSTUPAK PROIZVODNJE SPREMNIKA ZA PREHRAMBENE PROIZVODE METHOD TO MANUFACTURE A CONTAINER FOR FOOD PRODUCTS

MKP (51)	Broj patenta (11)	Naziv izuma (54)
<b>B65D 1/18</b> (2006.01)	P20231725	DVOMATERIJALNO PAKIRANJE IZRAĐENOG OD PLASTIKE I KARTONA ILI DRUGOG BIOLOŠKOG MATERIJALA SA POKRIVAČEM BI-MATERIAL PACKAGING MADE FROM PLASTIC AND CARDBOARD OR ANOTHER BIO-SOURCED MATERIAL WITH COVER.
<b>B65D 1/22</b> (2006.01)	P20231635	KUTIJA KOJU SE MOŽE NASLAGIVATI STACKABLE TRAY
<b>B65D 1/48</b> (2006.01)	P20231725	DVOMATERIJALNO PAKIRANJE IZRAĐENOG OD PLASTIKE I KARTONA ILI DRUGOG BIOLOŠKOG MATERIJALA SA POKRIVAČEM BI-MATERIAL PACKAGING MADE FROM PLASTIC AND CARDBOARD OR ANOTHER BIO-SOURCED MATERIAL WITH COVER.
<b>B65D 21/02</b> (2006.01)	P20231635	KUTIJA KOJU SE MOŽE NASLAGIVATI STACKABLE TRAY
<b>B65D 25/34</b> (2006.01)	P20231725	DVOMATERIJALNO PAKIRANJE IZRAĐENOG OD PLASTIKE I KARTONA ILI DRUGOG BIOLOŠKOG MATERIJALA SA POKRIVAČEM BI-MATERIAL PACKAGING MADE FROM PLASTIC AND CARDBOARD OR ANOTHER BIO-SOURCED MATERIAL WITH COVER.
<b>B65D 43/02</b> (2006.01)	P20231725	DVOMATERIJALNO PAKIRANJE IZRAĐENOG OD PLASTIKE I KARTONA ILI DRUGOG BIOLOŠKOG MATERIJALA SA POKRIVAČEM BI-MATERIAL PACKAGING MADE FROM PLASTIC AND CARDBOARD OR ANOTHER BIO-SOURCED MATERIAL WITH COVER.
<b>B65D 43/16</b> (2006.01)	P20231725	DVOMATERIJALNO PAKIRANJE IZRAĐENOG OD PLASTIKE I KARTONA ILI DRUGOG BIOLOŠKOG MATERIJALA SA POKRIVAČEM BI-MATERIAL PACKAGING MADE FROM PLASTIC AND CARDBOARD OR ANOTHER BIO-SOURCED MATERIAL WITH COVER.
<b>B65D 5/20</b> (2006.01)	P20231573	AMBALAŽA PACKAGING
<b>B65D 5/24</b> (2006.01)	P20231573	AMBALAŽA PACKAGING
<b>B65D 5/68</b> (2006.01)	P20231573	AMBALAŽA PACKAGING
<b>B65D 75/22</b> (2006.01)	P20231725	DVOMATERIJALNO PAKIRANJE IZRAĐENOG OD PLASTIKE I KARTONA ILI DRUGOG BIOLOŠKOG MATERIJALA SA POKRIVAČEM BI-MATERIAL PACKAGING MADE FROM PLASTIC AND CARDBOARD OR ANOTHER BIO-SOURCED MATERIAL WITH COVER.
<b>B65D 77/20</b> (2006.01)	P20231651	POSTUPAK PROIZVODNJE SPREMNIKA ZA PREHRAMBENE PROIZVODE METHOD TO MANUFACTURE A CONTAINER FOR FOOD PRODUCTS
<b>B65D 81/26</b> (2006.01)	P20231635	KUTIJA KOJU SE MOŽE NASLAGIVATI STACKABLE TRAY
<b>B65D 85/804</b> (2006.01)	P20231551	FILTER ZA PRIPREMU KAVE ILI INFUZIJE FILTER FOR PREPARING COFFEE OR INFUSION
<b>B65H 31/10</b> (2006.01)	P20231552	UREĐAJ ZA PRIMANJE NOVČANICA DEVICE FOR RECEIVING BANK NOTES
<b>B65H 31/22</b> (2006.01)	P20231552	UREĐAJ ZA PRIMANJE NOVČANICA DEVICE FOR RECEIVING BANK NOTES
<b>B65H 31/26</b> (2006.01)	P20231552	UREĐAJ ZA PRIMANJE NOVČANICA DEVICE FOR RECEIVING BANK NOTES
<b>B82Y 5/00</b> (2011.01)	P20231536	PLATFORME ZA PREGLED KEMIJSKI KODIRANIH PROSTORNO ADRESIRANIH BIBLIOTEKA CHEMICALLY ENCODED SPATIALLY ADDRESSED LIBRARY SCREENING PLATFORMS
<b>C04B 28/00</b> (2006.01)	P20231554	BETONSKI ELEMENT I POSTUPAK NJEGOVE PROIZVODNJE CONCRETE ELEMENT AND METHOD FOR THE PRODUCTION THEREOF
<b>C04B 28/02</b> (2006.01)	P20231554	BETONSKI ELEMENT I POSTUPAK NJEGOVE PROIZVODNJE CONCRETE ELEMENT AND METHOD FOR THE PRODUCTION THEREOF
<b>C04B 28/08</b> (2006.01)	P20231554	BETONSKI ELEMENT I POSTUPAK NJEGOVE PROIZVODNJE CONCRETE ELEMENT AND METHOD FOR THE PRODUCTION THEREOF
<b>C04B 28/12</b> (2006.01)	P20231554	BETONSKI ELEMENT I POSTUPAK NJEGOVE PROIZVODNJE CONCRETE ELEMENT AND METHOD FOR THE PRODUCTION THEREOF
<b>C04B 28/14</b> (2006.01)	P20231554	BETONSKI ELEMENT I POSTUPAK NJEGOVE PROIZVODNJE CONCRETE ELEMENT AND METHOD FOR THE PRODUCTION THEREOF
<b>C04B 28/26</b> (2006.01)	P20231554	BETONSKI ELEMENT I POSTUPAK NJEGOVE PROIZVODNJE CONCRETE ELEMENT AND METHOD FOR THE PRODUCTION THEREOF
<b>C04B 33/20</b> (2006.01)	P20231680	POSTUPAK I POSTROJENJE ZA PROIZVODNJU CRIJEP A KAO I CRIJEP METHOD AND SYSTEM FOR PRODUCING A ROOF TILE, AND ROOF TILE
<b>C04B 33/30</b> (2006.01)	P20231680	POSTUPAK I POSTROJENJE ZA PROIZVODNJU CRIJEP A KAO I CRIJEP METHOD AND SYSTEM FOR PRODUCING A ROOF TILE, AND ROOF TILE
<b>C07C 227/14</b> (2006.01)	P20231163	PROLIJEKOVI GLUTAMINSKIH ANALOGA PRODRUGS OF GLUTAMINE ANALOGS
<b>C07C 333/04</b> (2006.01)	P20231742	KATIONSKE LIPID KOJI SE MOŽE IONIZIRATI ZA ISPORUKU RNA IONIZABLE CATIONIC LIPID FOR RNA DELIVERY
<b>C07C 403/24</b> (2006.01)	P20231676	ESTERI AMARUCIAKSANTINA A I NJIHOVA UPOTREBA AMAROUICAXANTHIN A ESTERS AND USES THEREOF
<b>C07C 57/15</b> (2006.01)	P20231697	KRISTALNI OBLIK MAGL INHIBITORA A CRYSTALLINE FORM OF A MAGL INHIBITOR
<b>C07D 209/10</b> (2006.01)	P20231163	PROLIJEKOVI GLUTAMINSKIH ANALOGA PRODRUGS OF GLUTAMINE ANALOGS

MKP (51)	Broj patenta (11)	Naziv izuma (54)
<b>C07D 213/71</b> (2006.01)	P20231608	DERIVATI PIRIDINIL SULFONAMIDA, NJIHOVI FARMACEUTSKI PRIPRAVCI I NJIHOVE UPORABE PYRIDINYL SULFONAMIDE DERIVATIVES, PHARMACEUTICAL COMPOSITIONS AND USES THEREOF
<b>C07D 215/56</b> (2006.01)	P20231588	KOMBINACIJA KOJA SADRŽI STABILNI KRISTAL 4-OKSOKINOLINSKOG SPOJA COMBINATION COMPRISING A STABLE CRYSTAL OF A 4-OXOQUINOLINE COMPOUND
<b>C07D 223/16</b> (2006.01)	P20231616	DERIVATI BENZAZEPINA BENZAZEPINE DERIVATIVES
<b>C07D 231/12</b> (2006.01)	P20231690	SELEKTIVNI INHIBITORI NLRP3 INFLAMASOMA SELECTIVE INHIBITORS OF NLRP3 INFLAMMASOME
<b>C07D 233/56</b> (2006.01)	P20231690	SELEKTIVNI INHIBITORI NLRP3 INFLAMASOMA SELECTIVE INHIBITORS OF NLRP3 INFLAMMASOME
<b>C07D 237/08</b> (2006.01)	P20231690	SELEKTIVNI INHIBITORI NLRP3 INFLAMASOMA SELECTIVE INHIBITORS OF NLRP3 INFLAMMASOME
<b>C07D 239/12</b> (2006.01)	P20231571	DERIVATI FENIL/PIRIDIL-NH-FENIL/PIRIDIL ZA LIJEČENJE INFEKCIJA RNA VIRUSOM PHENYL/PYRIDYL-N-PHENYL/PYRIDYL DERIVATIVES FOR TREATING RNA VIRUS INFECTION
<b>C07D 239/16</b> (2006.01)	P20231571	DERIVATI FENIL/PIRIDIL-NH-FENIL/PIRIDIL ZA LIJEČENJE INFEKCIJA RNA VIRUSOM PHENYL/PYRIDYL-N-PHENYL/PYRIDYL DERIVATIVES FOR TREATING RNA VIRUS INFECTION
<b>C07D 239/26</b> (2006.01)	P20231690	SELEKTIVNI INHIBITORI NLRP3 INFLAMASOMA SELECTIVE INHIBITORS OF NLRP3 INFLAMMASOME
<b>C07D 239/69</b> (2006.01)	P20231639	MODULACIJSKA SREDSTVA TRANSMEMBRANSKOG REGULATORA PROVODLJIVOSTI CISTIČNE FIBROZE CYSTIC FIBROSIS TRANSMEMBRANE CONDUCTANCE REGULATOR MODULATING AGENTS
<b>C07D 241/12</b> (2006.01)	P20231690	SELEKTIVNI INHIBITORI NLRP3 INFLAMASOMA SELECTIVE INHIBITORS OF NLRP3 INFLAMMASOME
<b>C07D 243/24</b> (2006.01)	P20231538	FARMACEUTSKI SPOJ, POSTUPAK ZA NJEGOVU IZRADU I UPORABA KAO LIJEKOVITOG SREDSTVA PHARMACEUTICAL COMPOUND, THE METHOD OF ITS MAKING AND USE AS MEDICINAL AGENT
<b>C07D 249/08</b> (2006.01)	P20231690	SELEKTIVNI INHIBITORI NLRP3 INFLAMASOMA SELECTIVE INHIBITORS OF NLRP3 INFLAMMASOME
<b>C07D 295/205</b> (2006.01)	P20231697	KRISTALNI OBLIK MAGL INHIBITORA A CRYSTALLINE FORM OF A MAGL INHIBITOR
<b>C07D 307/87</b> (2006.01)	P20231690	SELEKTIVNI INHIBITORI NLRP3 INFLAMASOMA SELECTIVE INHIBITORS OF NLRP3 INFLAMMASOME
<b>C07D 317/40</b> (2006.01)	P20231163	PROLIJEKOVI GLUTAMINSKIH ANALOGA PRODRUGS OF GLUTAMINE ANALOGS
<b>C07D 401/04</b> (2006.01)	P20231547	POSTUPCI LIJEČENJA MULTIPLE SKLEROZE PRIMJENOM SPOJEVA PIRIMIDINA I PIRIDINA S AKTIVNOŠĆU INHIBICIJE BTK METHODS FOR TREATING MULTIPLE SCLEROSIS USING PYRIMIDINE AND PYRIDINE COMPOUNDS WITH BTK INHIBITORY ACTIVITY
<b>C07D 401/06</b> (2006.01)	P20231616	DERIVATI BENZAZEPINA BENZAZEPINE DERIVATIVES
<b>C07D 401/10</b> (2006.01)	P20231616	DERIVATI BENZAZEPINA BENZAZEPINE DERIVATIVES
<b>C07D 401/12</b> (2006.01)	P20231568	NOVA TERAPIJSKA UPOTREBA H3-LIGANADA NEW THERAPEUTICAL USE OF H3-LIGANDS
<b>C07D 401/12</b> (2006.01)	P20231571	DERIVATI FENIL/PIRIDIL-NH-FENIL/PIRIDIL ZA LIJEČENJE INFEKCIJA RNA VIRUSOM PHENYL/PYRIDYL-N-PHENYL/PYRIDYL DERIVATIVES FOR TREATING RNA VIRUS INFECTION
<b>C07D 401/12</b> (2006.01)	P20231608	DERIVATI PIRIDINIL SULFONAMIDA, NJIHOVI FARMACEUTSKI PRIPRAVCI I NJIHOVE UPORABE PYRIDINYL SULFONAMIDE DERIVATIVES, PHARMACEUTICAL COMPOSITIONS AND USES THEREOF
<b>C07D 401/12</b> (2006.01)	P20231618	POSTUPAK ZA PRIPREMU IVOSIDENIBA I NJEGOVOG INTERMEIJARA A METHOD FOR PREPARING IVOSIDENIB AND AN INTERMEDIATE THEREOF
<b>C07D 401/14</b> (2006.01)	P20231537	DERIVATI TETRAHIDRONAFTALENA I TETRAHIDROIZOKINOLINA KAO DEGRADATORI ESTROGENSKIH RECEPTORA TETRAHYDRONAPHTHALENE AND TETRAHYDROISOQUINOLINE DERIVATIVES AS ESTROGEN RECEPTOR DEGRADERS
<b>C07D 401/14</b> (2006.01)	P20231547	POSTUPCI LIJEČENJA MULTIPLE SKLEROZE PRIMJENOM SPOJEVA PIRIMIDINA I PIRIDINA S AKTIVNOŠĆU INHIBICIJE BTK METHODS FOR TREATING MULTIPLE SCLEROSIS USING PYRIMIDINE AND PYRIDINE COMPOUNDS WITH BTK INHIBITORY ACTIVITY
<b>C07D 401/14</b> (2006.01)	P20231608	DERIVATI PIRIDINIL SULFONAMIDA, NJIHOVI FARMACEUTSKI PRIPRAVCI I NJIHOVE UPORABE PYRIDINYL SULFONAMIDE DERIVATIVES, PHARMACEUTICAL COMPOSITIONS AND USES THEREOF
<b>C07D 401/14</b> (2006.01)	P20231616	DERIVATI BENZAZEPINA BENZAZEPINE DERIVATIVES
<b>C07D 401/14</b> (2006.01)	P20231618	POSTUPAK ZA PRIPREMU IVOSIDENIBA I NJEGOVOG INTERMEIJARA A METHOD FOR PREPARING IVOSIDENIB AND AN INTERMEDIATE THEREOF
<b>C07D 403/04</b> (2006.01)	P20231614	SPOJEVI PIROLOTRIAZINA KAO TAM INHIBITORI PYRROLOTRIAZINE COMPOUNDS AS TAM INHIBITORS



MKP (51)	Broj patenta (11)	Naziv izuma (54)
<b>C07D 403/06</b> (2006.01)	P20231616	DERIVATI BENZAZEPINA BENZAZEPINE DERIVATIVES
<b>C07D 403/12</b> (2006.01)	P20231547	POSTUPCI LIJEČENJA MULTIPLE SKLEROZE PRIMJENOM SPOJEVA PIRIMIDINA I PIRIDINA S AKTIVNOŠĆU INHIBICIJE BTK METHODS FOR TREATING MULTIPLE SCLEROSIS USING PYRIMIDINE AND PYRIDINE COMPOUNDS WITH BTK INHIBITORY ACTIVITY
<b>C07D 403/12</b> (2006.01)	P20231571	DERIVATI FENIL/PIRIDIL-NH-FENIL/PIRIDIL ZA LIJEČENJE INFEKCIJA RNA VIRUSOM PHENYL/PYRIDYL-N-PHENYL/PYRIDYL DERIVATIVES FOR TREATING RNA VIRUS INFECTION
<b>C07D 403/14</b> (2006.01)	P20231537	DERIVATI TETRAHIDRONAFTALENA I TETRAHIDROIZOKINOLINA KAO DEGRADATORI ESTROGENSKIH RECEPTORA TETRAHYDRONAPHTHALENE AND TETRAHYDROISOQUINOLINE DERIVATIVES AS ESTROGEN RECEPTOR DEGRADERS
<b>C07D 403/14</b> (2006.01)	P20231547	POSTUPCI LIJEČENJA MULTIPLE SKLEROZE PRIMJENOM SPOJEVA PIRIMIDINA I PIRIDINA S AKTIVNOŠĆU INHIBICIJE BTK METHODS FOR TREATING MULTIPLE SCLEROSIS USING PYRIMIDINE AND PYRIDINE COMPOUNDS WITH BTK INHIBITORY ACTIVITY
<b>C07D 403/14</b> (2006.01)	P20231614	SPOJEVI PIROLOTRIAZINA KAO TAM INHIBITORI PYRROLOTRIAZINE COMPOUNDS AS TAM INHIBITORS
<b>C07D 405/12</b> (2006.01)	P20231571	DERIVATI FENIL/PIRIDIL-NH-FENIL/PIRIDIL ZA LIJEČENJE INFEKCIJA RNA VIRUSOM PHENYL/PYRIDYL-N-PHENYL/PYRIDYL DERIVATIVES FOR TREATING RNA VIRUS INFECTION
<b>C07D 405/12</b> (2006.01)	P20231616	DERIVATI BENZAZEPINA BENZAZEPINE DERIVATIVES
<b>C07D 405/14</b> (2006.01)	P20231547	POSTUPCI LIJEČENJA MULTIPLE SKLEROZE PRIMJENOM SPOJEVA PIRIMIDINA I PIRIDINA S AKTIVNOŠĆU INHIBICIJE BTK METHODS FOR TREATING MULTIPLE SCLEROSIS USING PYRIMIDINE AND PYRIDINE COMPOUNDS WITH BTK INHIBITORY ACTIVITY
<b>C07D 405/14</b> (2006.01)	P20231586	AGONISTI RECEPTORA GLUKAGONU SLIČNOG PEPTIDA 1 GLUCAGON-LIKE PEPTIDE 1 RECEPTOR AGONISTS
<b>C07D 405/14</b> (2006.01)	P20231608	DERIVATI PIRIDINIL SULFONAMIDA, NJIHOVI FARMACEUTSKI PRIPRAVCI I NJIHOVE UPORABE PYRIDINYL SULFONAMIDE DERIVATIVES, PHARMACEUTICAL COMPOSITIONS AND USES THEREOF
<b>C07D 409/12</b> (2006.01)	P20231616	DERIVATI BENZAZEPINA BENZAZEPINE DERIVATIVES
<b>C07D 413/12</b> (2006.01)	P20231547	POSTUPCI LIJEČENJA MULTIPLE SKLEROZE PRIMJENOM SPOJEVA PIRIMIDINA I PIRIDINA S AKTIVNOŠĆU INHIBICIJE BTK METHODS FOR TREATING MULTIPLE SCLEROSIS USING PYRIMIDINE AND PYRIDINE COMPOUNDS WITH BTK INHIBITORY ACTIVITY
<b>C07D 413/12</b> (2006.01)	P20231571	DERIVATI FENIL/PIRIDIL-NH-FENIL/PIRIDIL ZA LIJEČENJE INFEKCIJA RNA VIRUSOM PHENYL/PYRIDYL-N-PHENYL/PYRIDYL DERIVATIVES FOR TREATING RNA VIRUS INFECTION
<b>C07D 413/14</b> (2006.01)	P20231547	POSTUPCI LIJEČENJA MULTIPLE SKLEROZE PRIMJENOM SPOJEVA PIRIMIDINA I PIRIDINA S AKTIVNOŠĆU INHIBICIJE BTK METHODS FOR TREATING MULTIPLE SCLEROSIS USING PYRIMIDINE AND PYRIDINE COMPOUNDS WITH BTK INHIBITORY ACTIVITY
<b>C07D 413/14</b> (2006.01)	P20231748	FARMACEUTSKA FORMULACIJA PHARMACEUTICAL FORMULATION
<b>C07D 417/14</b> (2006.01)	P20231537	DERIVATI TETRAHIDRONAFTALENA I TETRAHIDROIZOKINOLINA KAO DEGRADATORI ESTROGENSKIH RECEPTORA TETRAHYDRONAPHTHALENE AND TETRAHYDROISOQUINOLINE DERIVATIVES AS ESTROGEN RECEPTOR DEGRADERS
<b>C07D 471/04</b> (2006.01)	P20231673	INHIBITORI PRMT5 PRMT5 INHIBITORS
<b>C07D 471/18</b> (2006.01)	P20231654	SUPSTITUIRANI SPOJEVI PIRIDOTRIAZINA I NJIHOVE UPORABE SUBSTITUTED PYRIDOTRIAZINE COMPOUNDS AND USES THEREOF
<b>C07D 487/04</b> (2006.01)	P20231614	SPOJEVI PIROLOTRIAZINA KAO TAM INHIBITORI PYRROLOTRIAZINE COMPOUNDS AS TAM INHIBITORS
<b>C07D 487/10</b> (2006.01)	P20231734	TRICIKLIČKI AKR1C3 OVISNI KARS INHIBITORI TRICYCLIC AKR1C3 DEPENDENT KARS INHIBITORS
<b>C07D 495/04</b> (2006.01)	P20231547	POSTUPCI LIJEČENJA MULTIPLE SKLEROZE PRIMJENOM SPOJEVA PIRIMIDINA I PIRIDINA S AKTIVNOŠĆU INHIBICIJE BTK METHODS FOR TREATING MULTIPLE SCLEROSIS USING PYRIMIDINE AND PYRIDINE COMPOUNDS WITH BTK INHIBITORY ACTIVITY
<b>C07D 495/04</b> (2006.01)	P20231563	4-OKSO-3,4-DIHIDROTINO[3,4-D]PIRIDAZINSKI SPOJEVI KAO INHIBITORI ALDOSOREDUKTAZE I NAČINI NJIHOVE UPOTREBE 4-OXO-3,4-DIHYDROTHIENO[3,4-D]PYRIDAZINE COMPOUNDS AS ALDOSE REDUCTASE INHIBITORS AND METHODS OF USE THEREOF
<b>C07D 498/04</b> (2006.01)	P20231663	BICIKLIČKI DERIVATI HETEROARILA BICYCLIC HETEROARYL DERIVATIVES
<b>C07D 515/08</b> (2006.01)	P20231639	MODULACIJSKA SREDSTVA TRANSMEMBRANSKOG REGULATORA PROVODLJIVOSTI CISTIČNE FIBROZE CYSTIC FIBROSIS TRANSMEMBRANE CONDUCTANCE REGULATOR MODULATING AGENTS
<b>C07F 9/06</b> (2006.01)	P20231163	PROLIJEKOVI GLUTAMINSKIH ANALOGA PRODRUGS OF GLUTAMINE ANALOGS

MKP (51)	Broj patenta (11)	Naziv izuma (54)
<b>C07F 9/38</b> (2006.01)	P20231668	POSTUPAK ZA PRIPRAVU POLIMORFA F NATRIJEVOG NERIDRONATA PROCESS FOR THE PREPARATION OF THE POLYMORPH F OF SODIUM NERIDRONATE
<b>C07H 21/00</b> (2006.01)	P20231536	PLATFORME ZA PREGLED KEMIJSKI KODIRANIH PROSTORNO ADRESIRANIH BIBLIOTEKA CHEMICALLY ENCODED SPATIALLY ADDRESSED LIBRARY SCREENING PLATFORMS
<b>C07J 63/00</b> (2006.01)	P20231582	NOVI DERIVATI TRITERPENA KAO INHIBITORI HIV-A NOVEL TRITERPENE DERIVATIVES AS HIV INHIBITORS
<b>C07K 1/113</b> (2006.01)	P20231544	NABIJENA DUBINSKA FILTRACIJA PROTEINA KOJI VEŽU ANTIGENE CHARGED DEPTH FILTRATION OF ANTIGEN-BINDING PROTEINS
<b>C07K 1/34</b> (2006.01)	P20231544	NABIJENA DUBINSKA FILTRACIJA PROTEINA KOJI VEŽU ANTIGENE CHARGED DEPTH FILTRATION OF ANTIGEN-BINDING PROTEINS
<b>C07K 14/00</b> (2006.01)	P20231536	PLATFORME ZA PREGLED KEMIJSKI KODIRANIH PROSTORNO ADRESIRANIH BIBLIOTEKA CHEMICALLY ENCODED SPATIALLY ADDRESSED LIBRARY SCREENING PLATFORMS
<b>C07K 14/33</b> (2006.01)	P20231631	PRIPRAVCI KOJI SE ODOSE NA MUTANTNI TOKSIN IZ BAKTERIJE CLOSTRIDIUM DIFFICILE I ODGOVARAJUĆI POSTUPCI COMPOSITIONS RELATING TO A MUTANT CLOSTRIDIUM DIFFICILE TOXIN AND METHODS THEREOF
<b>C07K 14/33</b> (2006.01)	P20231749	IMUNOGENI PRIPRAVAK IMMUNOGENIC COMPOSITION
<b>C07K 14/435</b> (2006.01)	P20231542	KIMERNI ANTIGENSKI RECEPTORI KOJI CILJAJU BCMA I POSTUPCI NJIHOVE UPORABE CHIMERIC ANTIGEN RECEPTORS TARGETING BCMA AND METHODS OF USE THEREOF
<b>C07K 14/47</b> (2006.01)	P20231570	PEPTID ZA UPORABU U IMUNOTERAPIJI PROTIV NESITNOSTANIČNOG RAKA PLUĆA I SITNOSTANIČNOG RAKA PLUĆA PEPTIDE AND COMBINATION OF PEPTIDES FOR USE IN IMMUNOTHERAPY AGAINST NON- SMALL CELL LUNG CANCER AND OTHER CANCERS
<b>C07K 14/47</b> (2006.01)	P20231707	ŽIVOTINJE KOJE NISU LJUDI, KOJE SADRŽE HUMANIZIRANI GEN IZ DIFERENCIJACIJSKE SKUPINE 47 NON-HUMAN ANIMALS HAVING A HUMANIZED CLUSTER OF DIFFERENTIATION 47 GENE
<b>C07K 14/705</b> (2006.01)	P20231542	KIMERNI ANTIGENSKI RECEPTORI KOJI CILJAJU BCMA I POSTUPCI NJIHOVE UPORABE CHIMERIC ANTIGEN RECEPTORS TARGETING BCMA AND METHODS OF USE THEREOF
<b>C07K 14/705</b> (2006.01)	P20231637	ANTISENS OLIGOMERI ZA LIJEČENJE STANJA I BOLESTI ANTISENSE OLIGOMERS FOR TREATMENT OF CONDITIONS AND DISEASES
<b>C07K 14/705</b> (2006.01)	P20231707	ŽIVOTINJE KOJE NISU LJUDI, KOJE SADRŽE HUMANIZIRANI GEN IZ DIFERENCIJACIJSKE SKUPINE 47 NON-HUMAN ANIMALS HAVING A HUMANIZED CLUSTER OF DIFFERENTIATION 47 GENE
<b>C07K 14/72</b> (2006.01)	P20231567	PEPTIDI IZVEDENI IZ PROPEPTIDA NTSR3 I NJIHOVA UPORABA U LIJEČENJU DEPRESIJE PEPTIDES DERIVED FROM THE PROPEPTIDE NTSR3 AND THEIR USE IN THE TREATMENT OF DEPRESSION
<b>C07K 14/725</b> (2006.01)	P20231542	KIMERNI ANTIGENSKI RECEPTORI KOJI CILJAJU BCMA I POSTUPCI NJIHOVE UPORABE CHIMERIC ANTIGEN RECEPTORS TARGETING BCMA AND METHODS OF USE THEREOF
<b>C07K 14/725</b> (2006.01)	P20231645	T STANIČNI RECEPTORI T CELL RECEPTORS
<b>C07K 16/00</b> (2006.01)	P20231536	PLATFORME ZA PREGLED KEMIJSKI KODIRANIH PROSTORNO ADRESIRANIH BIBLIOTEKA CHEMICALLY ENCODED SPATIALLY ADDRESSED LIBRARY SCREENING PLATFORMS
<b>C07K 16/08</b> (2006.01)	P20231739	MOLEKULE ANTITIJELA VIRUSA ANTI-BK ANTI-BK VIRUS ANTIBODY MOLECULES
<b>C07K 16/12</b> (2006.01)	P20231631	PRIPRAVCI KOJI SE ODOSE NA MUTANTNI TOKSIN IZ BAKTERIJE CLOSTRIDIUM DIFFICILE I ODGOVARAJUĆI POSTUPCI COMPOSITIONS RELATING TO A MUTANT CLOSTRIDIUM DIFFICILE TOXIN AND METHODS THEREOF
<b>C07K 16/12</b> (2006.01)	P20231749	IMUNOGENI PRIPRAVAK IMMUNOGENIC COMPOSITION
<b>C07K 16/24</b> (2006.01)	P20231569	NOVA PROTUTIJELA PROTIV IL 13 I NJIHOVA UPOTREBA NOVEL ANTI-IL 13 ANTIBODIES AND USES THEREOF
<b>C07K 16/28</b> (2006.01)	P20231542	KIMERNI ANTIGENSKI RECEPTORI KOJI CILJAJU BCMA I POSTUPCI NJIHOVE UPORABE CHIMERIC ANTIGEN RECEPTORS TARGETING BCMA AND METHODS OF USE THEREOF
<b>C07K 16/28</b> (2006.01)	P20231570	PEPTID ZA UPORABU U IMUNOTERAPIJI PROTIV NESITNOSTANIČNOG RAKA PLUĆA I SITNOSTANIČNOG RAKA PLUĆA PEPTIDE AND COMBINATION OF PEPTIDES FOR USE IN IMMUNOTHERAPY AGAINST NON- SMALL CELL LUNG CANCER AND OTHER CANCERS
<b>C07K 16/28</b> (2006.01)	P20231578	MOLEKULE PROTUTIJELA NA APRIL I NJIHOVE UPORABE ANTIBODY MOLECULES TO APRIL AND USES THEREOF
<b>C07K 16/28</b> (2006.01)	P20231579	ANTI-CTLA-4 ANTITIJELA I POSTUPCI NJIHOVE UPOTREBE ANTI-CTLA-4 ANTIBODIES AND METHODS OF USE THEREOF
<b>C07K 16/28</b> (2006.01)	P20231609	KONJUGATI LIJEKA KOJI SADRŽE ANTITIJELA PROTIV KLAUDINA 18.2 DRUG CONJUGATES COMPRISING ANTIBODIES AGAINST CLAUDIN 18.2
<b>C07K 16/28</b> (2006.01)	P20231664	NOVA ANTI-PD-L1 ANTITIJELA NOVEL ANTI-PD-L1 ANTIBODIES
<b>C07K 16/28</b> (2006.01)	P20231707	ŽIVOTINJE KOJE NISU LJUDI, KOJE SADRŽE HUMANIZIRANI GEN IZ DIFERENCIJACIJSKE SKUPINE 47 NON-HUMAN ANIMALS HAVING A HUMANIZED CLUSTER OF DIFFERENTIATION 47 GENE
<b>C07K 16/30</b> (2006.01)	P20231542	KIMERNI ANTIGENSKI RECEPTORI KOJI CILJAJU BCMA I POSTUPCI NJIHOVE UPORABE CHIMERIC ANTIGEN RECEPTORS TARGETING BCMA AND METHODS OF USE THEREOF
<b>C07K 16/30</b> (2006.01)	P20231609	KONJUGATI LIJEKA KOJI SADRŽE ANTITIJELA PROTIV KLAUDINA 18.2 DRUG CONJUGATES COMPRISING ANTIBODIES AGAINST CLAUDIN 18.2

MKP (51)	Broj patenta (11)	Naziv izuma (54)
<b>C07K 17/00</b> (2006.01)	P20231536	PLATFORME ZA PREGLED KEMIJSKI KODIRANIH PROSTORNO ADRESIRANIH BIBLIOTEKA CHEMICALLY ENCODED SPATIALLY ADDRESSED LIBRARY SCREENING PLATFORMS
<b>C07K 19/00</b> (2006.01)	P20231542	KIMERNI ANTIGENSKI RECEPTORI KOJI CILJAJU BCMA I POSTUPCI NJIHOVE UPORABE CHIMERIC ANTIGEN RECEPTORS TARGETING BCMA AND METHODS OF USE THEREOF
<b>C07K 7/00</b> (2006.01)	P20231536	PLATFORME ZA PREGLED KEMIJSKI KODIRANIH PROSTORNO ADRESIRANIH BIBLIOTEKA CHEMICALLY ENCODED SPATIALLY ADDRESSED LIBRARY SCREENING PLATFORMS
<b>C07K 7/06</b> (2006.01)	P20231567	PEPTIDI IZVEDENI IZ PROPEPTIDA NTSR3 I NJIHOVA UPORABA U LIJEČENJU DEPRESIJE PEPTIDES DERIVED FROM THE PROPEPTIDE NTSR3 AND THEIR USE IN THE TREATMENT OF DEPRESSION
<b>C07K 7/08</b> (2006.01)	P20231567	PEPTIDI IZVEDENI IZ PROPEPTIDA NTSR3 I NJIHOVA UPORABA U LIJEČENJU DEPRESIJE PEPTIDES DERIVED FROM THE PROPEPTIDE NTSR3 AND THEIR USE IN THE TREATMENT OF DEPRESSION
<b>C08F 222/10</b> (2006.01)	P20231642	KONJUGATI POLIMER-LIJEK KOJI SE MOGU CIJEPATI CLEAVABLE POLYMER DRUG CONJUGATES
<b>C12M 1/00</b> (2006.01)	P20231727	FOTOBIOREAKTOR SA POKRETNIM UREĐAJEM ZA ODRŽAVANJE PHOTOBIOREACTOR AND METHOD FOR CULTIVATING MICROALGAE
<b>C12M 1/12</b> (2006.01)	P20231727	FOTOBIOREAKTOR SA POKRETNIM UREĐAJEM ZA ODRŽAVANJE PHOTOBIOREACTOR AND METHOD FOR CULTIVATING MICROALGAE
<b>C12N 15/09</b> (2006.01)	P20231664	NOVA ANTI-PD-L1 ANTITIJELA NOVEL ANTI-PD-L1 ANTIBODIES
<b>C12N 15/11</b> (2006.01)	P20231637	ANTISENSE OLIGOMERI ZA LIJEČENJE STANJA I BOLESTI ANTISENSE OLIGOMERS FOR TREATMENT OF CONDITIONS AND DISEASES
<b>C12N 15/113</b> (2010.01)	P20231525	POSTUPCI I PRIPRAVCI ZA DIJAGNOZU I LIJEČENJE RAKA METHODS AND COMPOSITIONS FOR DIAGNOSIS AND TREATMENT OF CANCER
<b>C12N 15/113</b> (2010.01)	P20231606	SPOJEVI I METODE ZA SMANJENJE EKSPRESIJE TAU COMPOUNDS AND METHODS FOR REDUCING TAU EXPRESSION
<b>C12N 15/62</b> (2006.01)	P20231542	KIMERNI ANTIGENSKI RECEPTORI KOJI CILJAJU BCMA I POSTUPCI NJIHOVE UPORABE CHIMERIC ANTIGEN RECEPTORS TARGETING BCMA AND METHODS OF USE THEREOF
<b>C12N 15/62</b> (2006.01)	P20231749	IMUNOGENI PRIPRAVAK IMMUNOGENIC COMPOSITION
<b>C12N 15/70</b> (2006.01)	P20231749	IMUNOGENI PRIPRAVAK IMMUNOGENIC COMPOSITION
<b>C12N 5/00</b> (2006.01)	P20231664	NOVA ANTI-PD-L1 ANTITIJELA NOVEL ANTI-PD-L1 ANTIBODIES
<b>C12N 5/10</b> (2006.01)	P20231542	KIMERNI ANTIGENSKI RECEPTORI KOJI CILJAJU BCMA I POSTUPCI NJIHOVE UPORABE CHIMERIC ANTIGEN RECEPTORS TARGETING BCMA AND METHODS OF USE THEREOF
<b>C12P 21/08</b> (2006.01)	P20231664	NOVA ANTI-PD-L1 ANTITIJELA NOVEL ANTI-PD-L1 ANTIBODIES
<b>C12Q 1/6883</b> (2018.01)	P20231637	ANTISENSE OLIGOMERI ZA LIJEČENJE STANJA I BOLESTI ANTISENSE OLIGOMERS FOR TREATMENT OF CONDITIONS AND DISEASES
<b>C40B 70/00</b> (2006.01)	P20231536	PLATFORME ZA PREGLED KEMIJSKI KODIRANIH PROSTORNO ADRESIRANIH BIBLIOTEKA CHEMICALLY ENCODED SPATIALLY ADDRESSED LIBRARY SCREENING PLATFORMS
<b>E02F 9/26</b> (2006.01)	P20231666	BRAVA ZA TROŠNI SKLOP A LOCK FOR A WEAR ASSEMBLY
<b>E02F 9/28</b> (2006.01)	P20231666	BRAVA ZA TROŠNI SKLOP A LOCK FOR A WEAR ASSEMBLY
<b>E04F 17/02</b> (2006.01)	P20231530	SPOJNICA ZA ROGOVE I PRIČVRSNI SUSTAV KOJI SE SASTOJI OD SPOJNICE ZA ROGOVE I BOČNIH NOSAČA ZA DRŽANJE OKOMITIH CIJEVI KAO ŠTO SU DIMNJACI RAFTER CONNECTOR AND RETAINING SYSTEM CONSISTING OF A RAFTER CONNECTOR AND A LATERAL SUPPORT FOR RETAINING VERTICAL LINES, SUCH AS FLUES
<b>E04F 17/04</b> (2006.01)	P20231530	SPOJNICA ZA ROGOVE I PRIČVRSNI SUSTAV KOJI SE SASTOJI OD SPOJNICE ZA ROGOVE I BOČNIH NOSAČA ZA DRŽANJE OKOMITIH CIJEVI KAO ŠTO SU DIMNJACI RAFTER CONNECTOR AND RETAINING SYSTEM CONSISTING OF A RAFTER CONNECTOR AND A LATERAL SUPPORT FOR RETAINING VERTICAL LINES, SUCH AS FLUES
<b>E04F 19/00</b> (2006.01)	P20231530	SPOJNICA ZA ROGOVE I PRIČVRSNI SUSTAV KOJI SE SASTOJI OD SPOJNICE ZA ROGOVE I BOČNIH NOSAČA ZA DRŽANJE OKOMITIH CIJEVI KAO ŠTO SU DIMNJACI RAFTER CONNECTOR AND RETAINING SYSTEM CONSISTING OF A RAFTER CONNECTOR AND A LATERAL SUPPORT FOR RETAINING VERTICAL LINES, SUCH AS FLUES
<b>E04F 19/08</b> (2006.01)	P20231724	UREĐAJ S OTVOROM ZA INSPEKCIJU INSPECTION OPENING DEVICE
<b>E04H 1/12</b> (2006.01)	P20231589	PALUBNA TOALETNA KABINA ON-BOARD TOILET CABIN
<b>E06B 3/36</b> (2006.01)	P20231589	PALUBNA TOALETNA KABINA ON-BOARD TOILET CABIN
<b>F01N 1/16</b> (2006.01)	P20231560	VENTIL ZA REGULACIJU PROTOKA PLINA I ZVUKA TE SUSTAV ZA ISPUŠNE PLINOVE GAS FLOW AND SOUND CONTROL VALVE AND EXHAUST GAS SYSTEM
<b>F01N 1/18</b> (2006.01)	P20231560	VENTIL ZA REGULACIJU PROTOKA PLINA I ZVUKA TE SUSTAV ZA ISPUŠNE PLINOVE GAS FLOW AND SOUND CONTROL VALVE AND EXHAUST GAS SYSTEM
<b>F01N 13/04</b> (2010.01)	P20231560	VENTIL ZA REGULACIJU PROTOKA PLINA I ZVUKA TE SUSTAV ZA ISPUŠNE PLINOVE GAS FLOW AND SOUND CONTROL VALVE AND EXHAUST GAS SYSTEM
<b>F01N 13/08</b> (2010.01)	P20231560	VENTIL ZA REGULACIJU PROTOKA PLINA I ZVUKA TE SUSTAV ZA ISPUŠNE PLINOVE GAS FLOW AND SOUND CONTROL VALVE AND EXHAUST GAS SYSTEM
<b>F16B 12/16</b> (2006.01)	P20231622	SREDSTVO ZA SPAJANJE I POSTUPAK SPAJANJA DVIJE KOMPONENTE FIXING MEANS AND METHOD FOR CONNECTING TWO COMPONENTS

MKP (51)	Broj patenta (11)	Naziv izuma (54)
<i>F16B 3/00</i> (2006.01)	P20231622	SREDSTVO ZA SPAJANJE I POSTUPAK SPAJANJA DVIJE KOMPONENTE FIXING MEANS AND METHOD FOR CONNECTING TWO COMPONENTS
<b>F16B 37/04</b> (2006.01)	P20231689	SKLOP ZA PRIČVRŠĆIVANJE FASTENING ASSEMBLY
<i>F16B 5/02</i> (2006.01)	P20231622	SREDSTVO ZA SPAJANJE I POSTUPAK SPAJANJA DVIJE KOMPONENTE FIXING MEANS AND METHOD FOR CONNECTING TWO COMPONENTS
<i>F16B 5/06</i> (2006.01)	P20231622	SREDSTVO ZA SPAJANJE I POSTUPAK SPAJANJA DVIJE KOMPONENTE FIXING MEANS AND METHOD FOR CONNECTING TWO COMPONENTS
<i>F16B 7/18</i> (2006.01)	P20231689	SKLOP ZA PRIČVRŠĆIVANJE FASTENING ASSEMBLY
<i>F16J 15/02</i> (2006.01)	P20231626	SKLOPOVI ZA ZATVARANJE IZMJENJIVAČA TOPLINE I POSTUPCI NJIHOVE UPOTREBE I UGRADNJE HEAT EXCHANGER CLOSURE ASSEMBLIES AND METHODS OF USING AND INSTALLING THE SAME
<i>F16J 15/06</i> (2006.01)	P20231627	SPOJNICA ZA POPRAVAK ZA POPRAVAK CJEVOVODA KOJIM MOŽE PROTJECATI TEKUČINA I ODGOVARAJUĆA METODA REPAIR COUPLING TO REPAIR A PIPELINE WHICH CAN BE CROSSED BY A FLUID AND RELEVANT METHOD
<i>F16K 1/00</i> (2006.01)	P20231560	VENTIL ZA REGULACIJU PROTOKA PLINA I ZVUKA TE SUSTAV ZA ISPUŠNE PLINOVE GAS FLOW AND SOUND CONTROL VALVE AND EXHAUST GAS SYSTEM
<i>F16K 1/02</i> (2006.01)	P20231624	ADAPTER GLAVE ZA PUNJENJE ZA STROJ ZA KARBONIZACIJU FILLING HEAD ADAPTER FOR CARBONATION MACHINE
<i>F16K 11/08</i> (2006.01)	P20231560	VENTIL ZA REGULACIJU PROTOKA PLINA I ZVUKA TE SUSTAV ZA ISPUŠNE PLINOVE GAS FLOW AND SOUND CONTROL VALVE AND EXHAUST GAS SYSTEM
<i>F16L 13/14</i> (2006.01)	P20231700	NAPRAVA ZA HVATANJE PREDMETA I ALAT ZA PRIČVRŠĆIVANJE CIJEVNOG SPOJA OBJECT GRASPING DEVICE AND SWAGING-TYPE TUBE FITTING FASTENING TOOL USING SAME
<i>F16L 55/17</i> (2006.01)	P20231627	SPOJNICA ZA POPRAVAK ZA POPRAVAK CJEVOVODA KOJIM MOŽE PROTJECATI TEKUČINA I ODGOVARAJUĆA METODA REPAIR COUPLING TO REPAIR A PIPELINE WHICH CAN BE CROSSED BY A FLUID AND RELEVANT METHOD
<i>F16L 55/172</i> (2006.01)	P20231627	SPOJNICA ZA POPRAVAK ZA POPRAVAK CJEVOVODA KOJIM MOŽE PROTJECATI TEKUČINA I ODGOVARAJUĆA METODA REPAIR COUPLING TO REPAIR A PIPELINE WHICH CAN BE CROSSED BY A FLUID AND RELEVANT METHOD
<i>F17C 1/00</i> (2006.01)	P20231624	ADAPTER GLAVE ZA PUNJENJE ZA STROJ ZA KARBONIZACIJU FILLING HEAD ADAPTER FOR CARBONATION MACHINE
<i>F23D 14/32</i> (2006.01)	P20231597	SKLOP KOJI UKLJUČUJE POSTROJENJE ZA IZGARANJE I SUSTAV ZA OPTIMIZACIJU ENERGIJE I OKOLIŠA ASSEMBLY COMPRISING A COMBUSTION FACILITY AND AN ENERGY AND ENVIRONMENTAL OPTIMIZATION SYSTEM
<i>F23L 7/00</i> (2006.01)	P20231597	SKLOP KOJI UKLJUČUJE POSTROJENJE ZA IZGARANJE I SUSTAV ZA OPTIMIZACIJU ENERGIJE I OKOLIŠA ASSEMBLY COMPRISING A COMBUSTION FACILITY AND AN ENERGY AND ENVIRONMENTAL OPTIMIZATION SYSTEM
<i>F23M 7/00</i> (2006.01)	P20231601	IZOLACIJSKI UREĐAJ POKLOPCA PLAMENIKA ZA KOTAO I POSTUPAK ZA PROIZVODNJU TAKVOG UREĐAJA BURNER COVER INSULATION DEVICE FOR A BOILER, AND METHOD FOR MANUFACTURING SUCH A DEVICE
<i>F23N 1/02</i> (2006.01)	P20231597	SKLOP KOJI UKLJUČUJE POSTROJENJE ZA IZGARANJE I SUSTAV ZA OPTIMIZACIJU ENERGIJE I OKOLIŠA ASSEMBLY COMPRISING A COMBUSTION FACILITY AND AN ENERGY AND ENVIRONMENTAL OPTIMIZATION SYSTEM
<i>F24D 18/00</i> (2022.01)	P20231597	SKLOP KOJI UKLJUČUJE POSTROJENJE ZA IZGARANJE I SUSTAV ZA OPTIMIZACIJU ENERGIJE I OKOLIŠA ASSEMBLY COMPRISING A COMBUSTION FACILITY AND AN ENERGY AND ENVIRONMENTAL OPTIMIZATION SYSTEM
<i>F24D 3/00</i> (2022.01)	P20231597	SKLOP KOJI UKLJUČUJE POSTROJENJE ZA IZGARANJE I SUSTAV ZA OPTIMIZACIJU ENERGIJE I OKOLIŠA ASSEMBLY COMPRISING A COMBUSTION FACILITY AND AN ENERGY AND ENVIRONMENTAL OPTIMIZATION SYSTEM
<i>F24F 110/65</i> (2018.01)	P20231585	ZATVORENA STRELJANA INDOOR SHOOTING RANGE
<i>F28D 20/00</i> (2006.01)	P20231340	POSTROJENJE ZA SKLADIŠTENJE TOPLINSKE ENERGIJE A THERMAL ENERGY STORAGE PLANT
<i>F28D 7/16</i> (2006.01)	P20231626	SKLOPOVI ZA ZATVARANJE IZMJENJIVAČA TOPLINE I POSTUPCI NJIHOVE UPOTREBE I UGRADNJE HEAT EXCHANGER CLOSURE ASSEMBLIES AND METHODS OF USING AND INSTALLING THE SAME
<i>F28F 27/00</i> (2006.01)	P20231626	SKLOPOVI ZA ZATVARANJE IZMJENJIVAČA TOPLINE I POSTUPCI NJIHOVE UPOTREBE I UGRADNJE HEAT EXCHANGER CLOSURE ASSEMBLIES AND METHODS OF USING AND INSTALLING THE SAME

MKP (51)	Broj patenta (11)	Naziv izuma (54)
<b>F28F 9/02</b> (2006.01)	P20231626	SKLOPOVI ZA ZATVARANJE IZMJENJIVAČA TOPLINE I POSTUPCI NJIHOVE UPOTREBE I UGRADNJE HEAT EXCHANGER CLOSURE ASSEMBLIES AND METHODS OF USING AND INSTALLING THE SAME
<b>F41A 9/69</b> (2006.01)	P20231590	KUČIŠTE OKVIRA ZA STRELJIVO ZA RUČNO VATRENO ORUŽJE I OKVIR ZA STRELJIVO ZA RUČNO VATRENO ORUŽJE HOUSING FOR A CARTRIDGE MAGAZINE FOR A HANDGUN AND CARTRIDGE MAGAZINE FOR A HANDGUN
<b>F41J 11/00</b> (2009.01)	P20231585	ZATVORENA STRELJANA INDOOR SHOOTING RANGE
<b>F41J 11/02</b> (2009.01)	P20231585	ZATVORENA STRELJANA INDOOR SHOOTING RANGE
<b>G01F 11/02</b> (2006.01)	P20231605	PATRONA I POSTUPAK ISPARAVANJA U SUSTAVU PATRONA S DIFUZOROM CARTRIDGE AND METHOD FOR VAPORIZING IN A CARTRIDGE SYSTEM WITH DIFFUSER
<b>G01F 23/14</b> (2006.01)	P20231593	UREĐAJ ZA MJERENJE RAZINE PUNJENJA KORIŠTENJEM SENZORA RAZINE PUNJENJA KOJI KONTINUIRANO MJERI I POSTUPAK ZA RUKOVANJE TAKVIM UREĐAJEM ZA MJERENJE RAZINE PUNJENJA FILL LEVEL MEASURING DEVICE USING A CONTINUOUSLY MEASURING FILL LEVEL SENSOR AND METHOD FOR OPERATING SUCH A FILL LEVEL MEASURING DEVICE
<b>G01F 23/24</b> (2006.01)	P20231593	UREĐAJ ZA MJERENJE RAZINE PUNJENJA KORIŠTENJEM SENZORA RAZINE PUNJENJA KOJI KONTINUIRANO MJERI I POSTUPAK ZA RUKOVANJE TAKVIM UREĐAJEM ZA MJERENJE RAZINE PUNJENJA FILL LEVEL MEASURING DEVICE USING A CONTINUOUSLY MEASURING FILL LEVEL SENSOR AND METHOD FOR OPERATING SUCH A FILL LEVEL MEASURING DEVICE
<b>G01F 23/26</b> (2022.01)	P20231593	UREĐAJ ZA MJERENJE RAZINE PUNJENJA KORIŠTENJEM SENZORA RAZINE PUNJENJA KOJI KONTINUIRANO MJERI I POSTUPAK ZA RUKOVANJE TAKVIM UREĐAJEM ZA MJERENJE RAZINE PUNJENJA FILL LEVEL MEASURING DEVICE USING A CONTINUOUSLY MEASURING FILL LEVEL SENSOR AND METHOD FOR OPERATING SUCH A FILL LEVEL MEASURING DEVICE
<b>G01F 23/284</b> (2006.01)	P20231593	UREĐAJ ZA MJERENJE RAZINE PUNJENJA KORIŠTENJEM SENZORA RAZINE PUNJENJA KOJI KONTINUIRANO MJERI I POSTUPAK ZA RUKOVANJE TAKVIM UREĐAJEM ZA MJERENJE RAZINE PUNJENJA FILL LEVEL MEASURING DEVICE USING A CONTINUOUSLY MEASURING FILL LEVEL SENSOR AND METHOD FOR OPERATING SUCH A FILL LEVEL MEASURING DEVICE
<b>G01F 23/80</b> (2022.01)	P20231593	UREĐAJ ZA MJERENJE RAZINE PUNJENJA KORIŠTENJEM SENZORA RAZINE PUNJENJA KOJI KONTINUIRANO MJERI I POSTUPAK ZA RUKOVANJE TAKVIM UREĐAJEM ZA MJERENJE RAZINE PUNJENJA FILL LEVEL MEASURING DEVICE USING A CONTINUOUSLY MEASURING FILL LEVEL SENSOR AND METHOD FOR OPERATING SUCH A FILL LEVEL MEASURING DEVICE
<b>G01N 33/50</b> (2006.01)	P20231576	DERIVATI SULFOPROPANSKE KISELINE ZA LIJEČENJE NEURODEGENERATIVNIH POREMEĆAJA SULFOPROPANOIC ACID DERIVATIVES FOR TREATING NEURODEGENERATIVE DISORDERS
<b>G01N 33/50</b> (2006.01)	P20231707	ŽIVOTINJE KOJE NISU LJUDI, KOJE SADRŽE HUMANIZIRANI GEN IZ DIFERENCIJACIJSKE SKUPINE 47 NON-HUMAN ANIMALS HAVING A HUMANIZED CLUSTER OF DIFFERENTIATION 47 GENE
<b>G01N 33/52</b> (2006.01)	P20231576	DERIVATI SULFOPROPANSKE KISELINE ZA LIJEČENJE NEURODEGENERATIVNIH POREMEĆAJA SULFOPROPANOIC ACID DERIVATIVES FOR TREATING NEURODEGENERATIVE DISORDERS
<b>G01N 33/53</b> (2006.01)	P20231569	NOVA PROTUTIJELA PROTIV IL 13 I NJIHOVA UPOTREBA NOVEL ANTI-IL 13 ANTIBODIES AND USES THEREOF
<b>G01N 33/543</b> (2006.01)	P20231536	PLATFORME ZA PREGLED KEMIJSKI KODIRANIH PROSTORNO ADRESIRANIH BIBLIOTEKA CHEMICALLY ENCODED SPATIALLY ADDRESSED LIBRARY SCREENING PLATFORMS
<b>G01N 33/68</b> (2006.01)	P20231592	ISPITIVANJE DETEKCIJE ALFA-SINUKLEINA I POSTUPAK DIJAGNOSTICIRANJA ALFA-SINUKLEINOPATIJE ALPHA-SYNUCLEIN DETECTION ASSAY AND METHOD FOR DIAGNOSING ALPHA-SYNUCLEINOPATHIES
<b>G01P 3/487</b> (2006.01)	P20231607	UREĐAJ ZA DOBIVANJE PODATAKA IZ KOJIH SE ODREĐUJE BRZINU VOZILA, NAPRAVA ZA PROCJENJIVANJE I ODGOVARAJUĆI POSTUPAK DEVICE FOR DETECTING DATA FOR DETERMINING THE SPEED OF A VEHICLE, EVALUATION DEVICE AND METHOD THEREFOR
<b>G01P 3/66</b> (2006.01)	P20231607	UREĐAJ ZA DOBIVANJE PODATAKA IZ KOJIH SE ODREĐUJE BRZINU VOZILA, NAPRAVA ZA PROCJENJIVANJE I ODGOVARAJUĆI POSTUPAK DEVICE FOR DETECTING DATA FOR DETERMINING THE SPEED OF A VEHICLE, EVALUATION DEVICE AND METHOD THEREFOR
<b>G01S 13/88</b> (2006.01)	P20231596	MIKROVALNI OSCILATOR I MIKROVALNI OSCILATOR MATRIČNOG TIPA UTEMELJEN NA NJEMU MICROWAVE OSCILLATOR AND MATRIX-TYPE MICROWAVE OSCILLATOR BASED THEREON
<b>G01S 7/03</b> (2006.01)	P20231596	MIKROVALNI OSCILATOR I MIKROVALNI OSCILATOR MATRIČNOG TIPA UTEMELJEN NA NJEMU MICROWAVE OSCILLATOR AND MATRIX-TYPE MICROWAVE OSCILLATOR BASED THEREON
<b>G05D 1/00</b> (2024.01)	P20231656	SUSTAV ZA PROVJERU CJELOVITOSTI BESPILOTNIH LETJELICA SYSTEM FOR VERIFICATION OF INTEGRITY OF UNMANNED AERIAL VEHICLES

MKP (51)	Broj patenta (11)	Naziv izuma (54)
<b>G05D 23/00</b> (2006.01)	P20231594	PROIZVODNA LINIJA S PROTOČNIM SUSTAVOM GRIJANJA I/ILI HLAĐENJA HRANE I GRIJANOM POVRŠINOM ZA RAZMNOŽAVANJE I/ILI UZGOJ INSEKATA, METODA UZGOJA INSEKATA I NJENA UPOTREBA PRODUCTION LINE WITH FLOW-THROUGH FEED HEATING AND/OR COOLING SYSTEM AND HEATED SURFACE FOR BREEDING INSECTS, METHOD FOR BREEDING INSECTS AND USES THEREOF
<b>G05D 23/00</b> (2006.01)	P20231595	PROIZVODNA POVRŠINA SA SUSTAVOM PODNOG GRIJANJA I/ILI HLAĐENJA HRANE ZA INSEKTE, UPOTREBA PODNOG SUSTAVA I NAČIN UZGOJA INSEKATA POMOĆU NJEGA PRODUCTION SURFACE WITH SYSTEM OF UNDERFLOOR HEATING AND/OR COOLING OF INSECT FEED, USE OF UNDERFLOOR SYSTEM AND METHOD FOR REARING INSECTS USING THEREOF
<b>G06F 21/44</b> (2013.01)	P20231656	SUSTAV ZA PROVJERU CJELOVITOSTI BESPILOTNIH LETJELICA SYSTEM FOR VERIFICATION OF INTEGRITY OF UNMANNED AERIAL VEHICLES
<b>G06F 21/57</b> (2013.01)	P20231656	SUSTAV ZA PROVJERU CJELOVITOSTI BESPILOTNIH LETJELICA SYSTEM FOR VERIFICATION OF INTEGRITY OF UNMANNED AERIAL VEHICLES
<b>G06F 21/64</b> (2013.01)	P20231656	SUSTAV ZA PROVJERU CJELOVITOSTI BESPILOTNIH LETJELICA SYSTEM FOR VERIFICATION OF INTEGRITY OF UNMANNED AERIAL VEHICLES
<b>G06F 7/00</b> (2006.01)	P20231656	SUSTAV ZA PROVJERU CJELOVITOSTI BESPILOTNIH LETJELICA SYSTEM FOR VERIFICATION OF INTEGRITY OF UNMANNED AERIAL VEHICLES
<b>G07D 11/12</b> (2019.01)	P20231552	UREĐAJ ZA PRIMANJE NOVČANICA DEVICE FOR RECEIVING BANK NOTES
<b>G07D 11/40</b> (2019.01)	P20231552	UREĐAJ ZA PRIMANJE NOVČANICA DEVICE FOR RECEIVING BANK NOTES
<b>G08B 21/04</b> (2006.01)	P20231577	UREĐAJ I SUSTAV ZA NADZOR PACIJENATA PATIENT MONITORING DEVICE AND ARRANGEMENT
<b>G10D 11/00</b> (2006.01)	P20231574	SKLOP PLOČE S JEZIČCIMA, NAMIJENJEN GLAZBALU S RUČNIM RAZVLAČENJEM, SKLOP ZVUČNIH ŠTAPIČA, NAMIJENJEN GLAZBALU S RUČNIM RAZVLAČENJEM KAO I GLAZBALO S RUČNIM RAZVLAČENJEM REED PLATE ARRANGEMENT FOR A MANUAL PULLING INSTRUMENT, SOUND POST ARRANGEMENT FOR A MANUAL PULLING INSTRUMENT, AND MANUAL PULLING INSTRUMENT
<b>G16B 20/00</b> (2019.01)	P20231604	NEINVAZIVNO PRENATALNO MOLEKULSKO KARIOTIPIZIRANJE IZ MAJČINSKE PLAZME NONINVASIVE PRENATAL MOLECULAR KARYOTYPING FROM MATERNAL PLASMA
<b>G16B 20/10</b> (2019.01)	P20231604	NEINVAZIVNO PRENATALNO MOLEKULSKO KARIOTIPIZIRANJE IZ MAJČINSKE PLAZME NONINVASIVE PRENATAL MOLECULAR KARYOTYPING FROM MATERNAL PLASMA
<b>G16H 20/13</b> (2018.01)	P20231605	PATRONA I POSTUPAK ISPARAVANJA U SUSTAVU PATRONA S DIFUZOROM CARTRIDGE AND METHOD FOR VAPORIZING IN A CARTRIDGE SYSTEM WITH DIFFUSER
<b>H01L 31/0224</b> (2006.01)	P20231741	FOTONAPONSKI UREĐAJ I POSTUPAK NJEGOVE PROIZVODNJE PHOTOVOLTAIC DEVICE AND METHOD FOR MANUFACTURING THE SAME
<b>H01L 31/0747</b> (2012.01)	P20231741	FOTONAPONSKI UREĐAJ I POSTUPAK NJEGOVE PROIZVODNJE PHOTOVOLTAIC DEVICE AND METHOD FOR MANUFACTURING THE SAME
<b>H02G 3/08</b> (2006.01)	P20231724	UREĐAJ S OTVOROM ZA INSPEKCIJU INSPECTION OPENING DEVICE
<b>H02J 7/00</b> (2006.01)	P20231696	VAPORIZATOR VAPORIZER
<b>H03B 1/04</b> (2006.01)	P20231596	MIKROVALNI OSCILATOR I MIKROVALNI OSCILATOR MATRIČNOG TIPA UTEMELJEN NA NJEMU MICROWAVE OSCILLATOR AND MATRIX-TYPE MICROWAVE OSCILLATOR BASED THEREON
<b>H03B 9/10</b> (2006.01)	P20231596	MIKROVALNI OSCILATOR I MIKROVALNI OSCILATOR MATRIČNOG TIPA UTEMELJEN NA NJEMU MICROWAVE OSCILLATOR AND MATRIX-TYPE MICROWAVE OSCILLATOR BASED THEREON
<b>H04L 65/10</b> (2022.01)	P20231623	POSTUPAK I SUSTAV ZA ISPORUKU AUDIO-VIZUALNIH SADRŽAJA UŽIVO METHOD AND SYSTEM FOR AUDIO-VISUAL LIVE CONTENT DELIVERY
<b>H04L 65/611</b> (2022.01)	P20231623	POSTUPAK I SUSTAV ZA ISPORUKU AUDIO-VIZUALNIH SADRŽAJA UŽIVO METHOD AND SYSTEM FOR AUDIO-VISUAL LIVE CONTENT DELIVERY
<b>H04L 65/612</b> (2022.01)	P20231610	POSTUPAK ZA PRIJENOS I PRIJAM MEDIJSKIH PODATAKA METHODS FOR TRANSMITTING OR RECEIVING MEDIA DATA
<b>H04L 65/612</b> (2022.01)	P20231623	POSTUPAK I SUSTAV ZA ISPORUKU AUDIO-VIZUALNIH SADRŽAJA UŽIVO METHOD AND SYSTEM FOR AUDIO-VISUAL LIVE CONTENT DELIVERY
<b>H04L 65/70</b> (2022.01)	P20231610	POSTUPAK ZA PRIJENOS I PRIJAM MEDIJSKIH PODATAKA METHODS FOR TRANSMITTING OR RECEIVING MEDIA DATA
<b>H04L 67/125</b> (2022.01)	P20231656	SUSTAV ZA PROVJERU CJELOVITOSTI BESPILOTNIH LETJELICA SYSTEM FOR VERIFICATION OF INTEGRITY OF UNMANNED AERIAL VEHICLES
<b>H04L 9/40</b> (2022.01)	P20231656	SUSTAV ZA PROVJERU CJELOVITOSTI BESPILOTNIH LETJELICA SYSTEM FOR VERIFICATION OF INTEGRITY OF UNMANNED AERIAL VEHICLES
<b>H04N 19/105</b> (2014.01)	P20231695	POSTUPAK KODIRANJA SLIKE NA TEMELJU POVIJESTI HISTORY-BASED IMAGE CODING METHODS
<b>H04N 19/12</b> (2014.01)	P20231634	TRANSFORMACIJA NAMIJENJENA UNUTARNJEM PREDVIĐANJU NA TEMELJU MATRICE PRILIKOM KODIRANJA SLIKE TRANSFORM FOR MATRIX-BASED INTRA-PREDICTION IN IMAGE CODING
<b>H04N 19/132</b> (2014.01)	P20231634	TRANSFORMACIJA NAMIJENJENA UNUTARNJEM PREDVIĐANJU NA TEMELJU MATRICE PRILIKOM KODIRANJA SLIKE TRANSFORM FOR MATRIX-BASED INTRA-PREDICTION IN IMAGE CODING
<b>H04N 19/132</b> (2014.01)	P20231695	POSTUPAK KODIRANJA SLIKE NA TEMELJU POVIJESTI HISTORY-BASED IMAGE CODING METHODS

MKP (51)	Broj patenta (11)	Naziv izuma (54)
<b>H04N 19/159</b> (2014.01)	P20231634	TRANSFORMACIJA NAMIJENJENA UNUTARNJEM PREDVIĐANJU NA TEMELJU MATRICE PRILIKOM KODIRANJA SLIKE TRANSFORM FOR MATRIX-BASED INTRA-PREDICTION IN IMAGE CODING
<b>H04N 19/174</b> (2014.01)	P20231695	POSTUPAK KODIRANJA SLIKE NA TEMELJU POVIJESTI HISTORY-BASED IMAGE CODING METHODS
<b>H04N 19/176</b> (2014.01)	P20231695	POSTUPAK KODIRANJA SLIKE NA TEMELJU POVIJESTI HISTORY-BASED IMAGE CODING METHODS
<b>H04N 19/18</b> (2014.01)	P20231634	TRANSFORMACIJA NAMIJENJENA UNUTARNJEM PREDVIĐANJU NA TEMELJU MATRICE PRILIKOM KODIRANJA SLIKE TRANSFORM FOR MATRIX-BASED INTRA-PREDICTION IN IMAGE CODING
<b>H04N 19/196</b> (2014.01)	P20231736	UREĐAJ ZA KODIRANJE SLIKE, POSTUPAK KODIRANJA SLIKE, UREĐAJ ZA DEKODIRANJE SLIKE, POSTUPAK DEKODIRANJA SLIKE I PROGRAM IMAGE CODING APPARATUS, IMAGE CODING METHOD, IMAGE DECODING APPARATUS, IMAGE DECODING METHOD, AND PROGRAM
<b>H04N 19/196</b> (2014.01)	P20231737	UREĐAJ ZA KODIRANJE SLIKE, POSTUPAK KODIRANJA SLIKE, UREĐAJ ZA DEKODIRANJE SLIKE, POSTUPAK DEKODIRANJA SLIKE I PROGRAM IMAGE CODING APPARATUS, IMAGE CODING METHOD, IMAGE DECODING APPARATUS, IMAGE DECODING METHOD, AND PROGRAM
<b>H04N 19/43</b> (2014.01)	P20231726	POSTUPAK I UREĐAJ ZA KODIRANJE SEKVENCE SLIKA I POSTUPAK I UREĐAJ ZA DEKODIRANJE SEKVENCE SLIKA METHOD AND DEVICE FOR ENCODING A SEQUENCE OF IMAGES AND METHOD AND DEVICE FOR DECODING A SEQUENCE OF IMAGES
<b>H04N 19/436</b> (2014.01)	P20231736	UREĐAJ ZA KODIRANJE SLIKE, POSTUPAK KODIRANJA SLIKE, UREĐAJ ZA DEKODIRANJE SLIKE, POSTUPAK DEKODIRANJA SLIKE I PROGRAM IMAGE CODING APPARATUS, IMAGE CODING METHOD, IMAGE DECODING APPARATUS, IMAGE DECODING METHOD, AND PROGRAM
<b>H04N 19/436</b> (2014.01)	P20231737	UREĐAJ ZA KODIRANJE SLIKE, POSTUPAK KODIRANJA SLIKE, UREĐAJ ZA DEKODIRANJE SLIKE, POSTUPAK DEKODIRANJA SLIKE I PROGRAM IMAGE CODING APPARATUS, IMAGE CODING METHOD, IMAGE DECODING APPARATUS, IMAGE DECODING METHOD, AND PROGRAM
<b>H04N 19/46</b> (2014.01)	P20231736	UREĐAJ ZA KODIRANJE SLIKE, POSTUPAK KODIRANJA SLIKE, UREĐAJ ZA DEKODIRANJE SLIKE, POSTUPAK DEKODIRANJA SLIKE I PROGRAM IMAGE CODING APPARATUS, IMAGE CODING METHOD, IMAGE DECODING APPARATUS, IMAGE DECODING METHOD, AND PROGRAM
<b>H04N 19/46</b> (2014.01)	P20231737	UREĐAJ ZA KODIRANJE SLIKE, POSTUPAK KODIRANJA SLIKE, UREĐAJ ZA DEKODIRANJE SLIKE, POSTUPAK DEKODIRANJA SLIKE I PROGRAM IMAGE CODING APPARATUS, IMAGE CODING METHOD, IMAGE DECODING APPARATUS, IMAGE DECODING METHOD, AND PROGRAM
<b>H04N 19/513</b> (2014.01)	P20231695	POSTUPAK KODIRANJA SLIKE NA TEMELJU POVIJESTI HISTORY-BASED IMAGE CODING METHODS
<b>H04N 19/52</b> (2014.01)	P20231669	INTER PREDIKCIJA INTER PREDICTION
<b>H04N 19/593</b> (2014.01)	P20231580	POSTUPAK ZA DIJELJENJE BLOKA I UREĐAJ ZA DEKODIRANJE METHOD FOR PARTITIONING BLOCK AND DECODING DEVICE
<b>H04N 19/70</b> (2014.01)	P20231580	POSTUPAK ZA DIJELJENJE BLOKA I UREĐAJ ZA DEKODIRANJE METHOD FOR PARTITIONING BLOCK AND DECODING DEVICE
<b>H04N 19/70</b> (2014.01)	P20231695	POSTUPAK KODIRANJA SLIKE NA TEMELJU POVIJESTI HISTORY-BASED IMAGE CODING METHODS
<b>H04N 19/91</b> (2014.01)	P20231736	UREĐAJ ZA KODIRANJE SLIKE, POSTUPAK KODIRANJA SLIKE, UREĐAJ ZA DEKODIRANJE SLIKE, POSTUPAK DEKODIRANJA SLIKE I PROGRAM IMAGE CODING APPARATUS, IMAGE CODING METHOD, IMAGE DECODING APPARATUS, IMAGE DECODING METHOD, AND PROGRAM
<b>H04N 19/91</b> (2014.01)	P20231737	UREĐAJ ZA KODIRANJE SLIKE, POSTUPAK KODIRANJA SLIKE, UREĐAJ ZA DEKODIRANJE SLIKE, POSTUPAK DEKODIRANJA SLIKE I PROGRAM IMAGE CODING APPARATUS, IMAGE CODING METHOD, IMAGE DECODING APPARATUS, IMAGE DECODING METHOD, AND PROGRAM
<b>H04N 21/6405</b> (2011.01)	P20231623	POSTUPAK I SUSTAV ZA ISPORUKU AUDIO-VIZUALNIH SADRŽAJA UŽIVO METHOD AND SYSTEM FOR AUDIO-VISUAL LIVE CONTENT DELIVERY
<b>H04N 21/6408</b> (2011.01)	P20231623	POSTUPAK I SUSTAV ZA ISPORUKU AUDIO-VIZUALNIH SADRŽAJA UŽIVO METHOD AND SYSTEM FOR AUDIO-VISUAL LIVE CONTENT DELIVERY
<b>H04N 21/854</b> (2011.01)	P20231610	POSTUPAK ZA PRIJENOS I PRIJAM MEDIJSKIH PODATAKA METHODS FOR TRANSMITTING OR RECEIVING MEDIA DATA
<b>H04N 23/617</b> (2023.01)	P20231559	APLIKACIJA ZA KAMERU CAMERA APPLICATION
<b>H04N 23/63</b> (2023.01)	P20231559	APLIKACIJA ZA KAMERU CAMERA APPLICATION
<b>H04W 12/10</b> (2021.01)	P20231656	SUSTAV ZA PROVJERU CJELOVITOSTI BESPILOTNIH LETJELICA SYSTEM FOR VERIFICATION OF INTEGRITY OF UNMANNED AERIAL VEHICLES
<b>H05B 6/70</b> (2006.01)	P20231596	MIKROVALNI OSCILATOR I MIKROVALNI OSCILATOR MATRIČNOG TIPA UTEMELJEN NA NJEMU MICROWAVE OSCILLATOR AND MATRIX-TYPE MICROWAVE OSCILLATOR BASED THEREON

## Kazalo nositelja europskih patenata

Nositelj patenta (73)	MKP (51)	Broj patenta (11)	Naziv izuma (54)
Aalborg CSP A/S, DK	<b>F28D 20/00</b> (2006.01)	P20231340	POSTROJENJE ZA SKLADIŠTENJE TOPLINSKE ENERGIJE
Abiogen Pharma S.p.A., IT	<b>C07F 9/38</b> (2006.01)	P20231668	POSTUPAK ZA PRIPRAVU POLIMORFA F NATRIJEVOG NERIDRONATA
ABIVAX, FR	<b>C07D 239/16</b> (2006.01) <b>C07D 239/12</b> (2006.01) <b>C07D 401/12</b> (2006.01) <b>C07D 403/12</b> (2006.01) <b>C07D 405/12</b> (2006.01) <b>C07D 413/12</b> (2006.01) <b>A61K 31/505</b> (2006.01) <b>A61P 31/14</b> (2006.01)	P20231571	DERIVATI FENIL/PIRIDIL-NH-FENIL/PIRIDIL ZA LIJEČENJE INFEKCIJA RNA VIRUSOM
Agenus Inc., US	<b>C07K 16/28</b> (2006.01) <b>A61K 39/00</b> (2006.01) <b>A61P 11/00</b> (2006.01) <b>A61P 35/04</b> (2006.01)	P20231579	ANTI-CTLA-4 ANTITIJELA I POSTUPCI NJIHOVE UPOTREBE
Akrapovic d.d., SI	<b>F01N 13/04</b> (2010.01) <b>F01N 13/08</b> (2010.01) <b>F01N 1/16</b> (2006.01) <b>F01N 1/18</b> (2006.01) <b>F16K 1/00</b> (2006.01) <b>F16K 11/08</b> (2006.01)	P20231560	VENTIL ZA REGULACIJU PROTOKA PLINA I ZVUKA TE SUSTAV ZA ISPUŠNE PLINOVE
Alfasigma S.p.A., IT	<b>A61K 31/353</b> (2006.01) <b>A61K 9/20</b> (2006.01) <b>A61K 9/28</b> (2006.01) <b>A61K 36/45</b> (2006.01) <b>A61P 1/00</b> (2006.01) <b>A61P 1/04</b> (2006.01)	P20231691	PRIPRAVAK ZA UPOTREBU U LIJEČENJU PROMJENA U CRIJEVIMA
Alzheon, Inc., US	<b>A61K 31/221</b> (2006.01) <b>A61K 31/222</b> (2006.01) <b>A61K 31/223</b> (2006.01) <b>A61K 31/225</b> (2006.01) <b>A61K 31/255</b> (2006.01) <b>A61P 25/28</b> (2006.01) <b>G01N 33/50</b> (2006.01) <b>G01N 33/52</b> (2006.01)	P20231576	DERIVATI SULFOPROPANSKE KISELINE ZA LIJEČENJE NEURODEGENERATIVNIH POREMEĆAJA
Amgen Inc., US	<b>C07K 1/113</b> (2006.01) <b>C07K 1/34</b> (2006.01) <b>B01D 15/36</b> (2006.01) <b>B01D 15/38</b> (2006.01)	P20231544	NABIJENA DUBINSKA FILTRACIJA PROTEINA KOJI VEŽU ANTIGENE
ANEIRA PHARMA, INC., US	<b>A61K 8/37</b> (2006.01) <b>A61K 8/49</b> (2006.01) <b>A61K 8/64</b> (2006.01) <b>A61P 17/14</b> (2006.01) <b>A61Q 7/00</b> (2006.01)	P20231629	PRIPRAVCI ZA LIJEČENJE OPADANJA KOSE
Aquanova AG, DE	<b>A61K 47/26</b> (2006.01) <b>A61K 9/107</b> (2006.01) <b>A61K 31/12</b> (2006.01) <b>A61P 3/06</b> (2006.01) <b>A61P 3/04</b> (2006.01) <b>A61P 3/10</b> (2006.01) <b>A61K 31/352</b> (2006.01) <b>A61K 36/185</b> (2006.01) <b>A61K 36/9066</b> (2006.01) <b>A61P 1/16</b> (2006.01) <b>A61K 36/484</b> (2006.01)	P20231591	SOLUBILIZAT S KURKUMINOM I BAREM JEDNOM DRUGOM AKTIVNOM TVARI
Arcturus Therapeutics, Inc., US	<b>C07C 333/04</b> (2006.01)	P20231742	KATIONSKE LIPID KOJI SE MOŽE IONIZIRATI ZA ISPORUKU RNA
Armonie Sante, FR	<b>A01N 31/06</b> (2006.01) <b>A01N 65/22</b> (2009.01) <b>A01N 25/04</b> (2006.01) <b>A01N 25/28</b> (2006.01) <b>A01P 17/00</b> (2006.01)	P20231662	REPELENTNI PRIPRAVAK PROTIV INSEKATA PRENOSITELJA TROPSKIH BOLESTI U OBLIKU SPREJA
Arvinas Operations, Inc., US	<b>C07D 417/14</b> (2006.01) <b>C07D 401/14</b> (2006.01) <b>C07D 403/14</b> (2006.01) <b>A61K 31/4725</b> (2006.01) <b>A61P 15/00</b> (2006.01)	P20231537	DERIVATI TETRAHIDRONAFTALENA I TETRAHIDROIZOKINOLINA KAO DEGRADATORI ESTROGENSKIH RECEPTORA
Astellas Pharma Inc., JP	<b>A61P 35/00</b> (2006.01) <b>A61P 35/04</b> (2006.01) <b>A61P 37/04</b> (2006.01) <b>C12N 15/113</b> (2010.01) <b>A61K 31/7088</b> (2006.01)	P20231525	POSTUPCI I PRIPRAVCI ZA DIJAGNOZU I LIJEČENJE RAKA



Nositelj patenta (73)	MKP (51)	Broj patenta (11)	Naziv izuma (54)
Astellas Pharma Inc., JP	<b>C07K 16/28</b> (2006.01) <b>C07K 16/30</b> (2006.01) <b>A61K 47/68</b> (2017.01) <b>A61P 35/00</b> (2006.01) <b>A61K 31/40</b> (2006.01)	P20231609	KONJUGATI LIJEKA KOJI SADRŽE ANTITIJELA PROTIV KLAUDINA 18.2
Barilla G. e R. Fratelli S.p.A., IT	<b>A23L 7/109</b> (2016.01) <b>A23P 30/20</b> (2016.01)	P20231648	POSTUPAK ZA PROIZVODNJU PREHRAMBENOG PROIZVODA OD TJESTENINE EKSTRUZIJOM KROZ UMETAK NAPRAVLJEN OD POLIACETALNE SMOLE I SRODNI PROIZVOD
Baur, Franz, DE	<b>F16B 12/16</b> (2006.01) <b>F16B 5/06</b> (2006.01) <b>F16B 5/02</b> (2006.01) <b>F16B 3/00</b> (2006.01)	P20231622	SREDSTVO ZA SPAJANJE I POSTUPAK SPAJANJA DVIJE KOMPONENTE
Beco Invest B.V., NL	<b>C12M 1/00</b> (2006.01) <b>C12M 1/12</b> (2006.01)	P20231727	FOTOBIOREAKTOR SA POKRETNIM UREĐAJEM ZA ODRŽAVANJE
Beezbutt PTY Limited, AU	<b>H04N 23/617</b> (2023.01) <b>H04N 23/63</b> (2023.01)	P20231559	APLIKACIJA ZA KAMERU
Biogen MA Inc., US	<b>C12N 15/113</b> (2010.01)	P20231606	SPOJEVI I METODE ZA SMANJENJE EKSPRESIJE TAU
BIOPROJET Pharma, FR	<b>A61K 31/4545</b> (2006.01) <b>C07D 401/12</b> (2006.01) <b>A61P 3/00</b> (2006.01) <b>A61P 3/10</b> (2006.01) <b>A61P 25/16</b> (2006.01) <b>A61P 25/08</b> (2006.01) <b>A61P 25/32</b> (2006.01) <b>A61P 25/24</b> (2006.01) <b>A61P 25/00</b> (2006.01) <b>A61P 43/00</b> (2006.01)	P20231568	NOVA TERAPIJSKA UPOTREBA H3-LIGANADA
BMI Deutschland GmbH, DE	<b>B28C 1/18</b> (2006.01) <b>C04B 33/20</b> (2006.01) <b>C04B 33/30</b> (2006.01) <b>B28B 17/02</b> (2006.01) <b>B28B 3/02</b> (2006.01)	P20231680	POSTUPAK I POSTROJENJE ZA PROIZVODNJU CRIJEPA KAO I CRIJEP
Boehringer Ingelheim Animal Health USA Inc., US	<b>A61K 39/12</b> (2006.01) <b>A61K 39/00</b> (2006.01) <b>A61K 39/23</b> (2006.01) <b>A61K 39/135</b> (2006.01) <b>A61P 31/00</b> (2006.01) <b>A61P 31/20</b> (2006.01)	P20231630	CJEPIVA SA ČESTICAMA NALIK NA VIRUS (VLP) PSEĆEG PARVOVIRUSA (CPV) I NJIHOVE UPORABE
Boehringer Ingelheim International GmbH, DE	<b>A61P 1/16</b> (2006.01) <b>A61P 9/00</b> (2006.01) <b>A61P 11/00</b> (2006.01) <b>A61P 13/12</b> (2006.01) <b>A61P 27/00</b> (2006.01) <b>A61P 35/00</b> (2006.01) <b>C07D 405/14</b> (2006.01) <b>C07D 213/71</b> (2006.01) <b>C07D 401/12</b> (2006.01) <b>C07D 401/14</b> (2006.01) <b>A61K 31/454</b> (2006.01) <b>A61K 31/4545</b> (2006.01) <b>A61K 31/5377</b> (2006.01) <b>A61K 45/06</b> (2006.01)	P20231608	DERIVATI PIRIDINIL SULFONAMIDA, NJIHOVI FARMACEUTSKI PRIPRAVCI I NJIHOVE UPORABE
Boehringer Ingelheim Vetmedica GmbH, DE	<b>A61K 31/7034</b> (2006.01) <b>A61K 31/198</b> (2006.01) <b>A61K 31/351</b> (2006.01) <b>A61K 31/401</b> (2006.01) <b>A61K 38/28</b> (2006.01) <b>A61K 9/08</b> (2006.01) <b>A61P 25/00</b> (2006.01) <b>A61P 29/00</b> (2006.01) <b>A61P 43/00</b> (2006.01) <b>A61P 3/00</b> (2006.01) <b>A61P 3/10</b> (2006.01) <b>A61P 5/50</b> (2006.01) <b>A61P 9/10</b> (2006.01)	P20231694	SGLT-2 INHIBITOR ZA UPORABU U LIJEČENJU METABOLIČKOG POREMEĆAJA KOD ŽIVOTINJA IZ PORODICE MAČAKA
Breath Therapeutics GmbH, DE	<b>A61K 38/13</b> (2006.01) <b>A61P 37/06</b> (2006.01) <b>A61K 9/00</b> (2006.01) <b>A61K 47/26</b> (2006.01) <b>A61K 9/127</b> (2006.01) <b>A61K 9/19</b> (2006.01)	P20231621	FORMULACIJE CIKLOSPORINA ZA UPOTREBU U PREVENCIJI ILI LIJEČENJU PLUĆNOG KRONIČNOG ODBACIVANJA TRANSPLANTANTA
Broadpeak, FR	<b>H04L 65/611</b> (2022.01) <b>H04L 65/612</b> (2022.01) <b>H04L 65/10</b> (2022.01) <b>H04N 21/6405</b> (2011.01) <b>H04N 21/6408</b> (2011.01)	P20231623	POSTUPAK I SUSTAV ZA ISPORUKU AUDIO-VIZUALNIH SADRŽAJA UŽIVO

Nositelj patenta (73)	MKP (51)	Broj patenta (11)	Naziv izuma (54)
Bulane, FR	<b>F23D 14/32</b> (2006.01) <b>F23N 1/02</b> (2006.01) <b>F24D 3/00</b> (2022.01) <b>F23L 7/00</b> (2006.01) <b>F24D 18/00</b> (2022.01)	P20231597	SKLOP KOJI UKLJUČUJE POSTROJENJE ZA IZGARANJE I SUSTAV ZA OPTIMIZACIJU ENERGIJE I OKOLIŠA
CANON KABUSHIKI KAISHA, JP	<b>H04N 19/43</b> (2014.01)	P20231726	POSTUPAK I UREĐAJ ZA KODIRANJE SEKVENCE SLIKA I POSTUPAK I UREĐAJ ZA DEKODIRANJE SEKVENCE SLIKA
CANON KABUSHIKI KAISHA, JP	<b>H04N 19/196</b> (2014.01) <b>H04N 19/46</b> (2014.01) <b>H04N 19/436</b> (2014.01) <b>H04N 19/91</b> (2014.01)	P20231736	UREĐAJ ZA KODIRANJE SLIKE, POSTUPAK KODIRANJA SLIKE, UREĐAJ ZA DEKODIRANJE SLIKE, POSTUPAK DEKODIRANJA SLIKE I PROGRAM
CANON KABUSHIKI KAISHA, JP	<b>H04N 19/196</b> (2014.01) <b>H04N 19/46</b> (2014.01) <b>H04N 19/436</b> (2014.01) <b>H04N 19/91</b> (2014.01)	P20231737	UREĐAJ ZA KODIRANJE SLIKE, POSTUPAK KODIRANJA SLIKE, UREĐAJ ZA DEKODIRANJE SLIKE, POSTUPAK DEKODIRANJA SLIKE I PROGRAM
Carboneon GmbH, CH	<b>G10D 11/00</b> (2006.01)	P20231574	SKLOP PLOČE S JEZIČCIMA, NAMIJENJEN GLAZBALU S RUČNIM RAZVLAČENJEM, SKLOP ZVUČNIH ŠTAPIĆA, NAMIJENJEN GLAZBALU S RUČNIM RAZVLAČENJEM KAO I GLAZBALO S RUČNIM RAZVLAČENJEM
Centre National de la Recherche Scientifique, FR	<b>C07K 14/72</b> (2006.01) <b>A61K 38/08</b> (2019.01) <b>A61K 38/10</b> (2006.01) <b>C07K 7/06</b> (2006.01) <b>C07K 7/08</b> (2006.01)	P20231567	PEPTIDI IZVEDENI IZ PROPEPTIDA NTSR3 I NJIHOVA UPORABA U LIJEČENJU DEPRESIJE
Certis Belchim NV, BE	<b>A01N 37/02</b> (2006.01) <b>A01N 47/36</b> (2006.01) <b>A01P 13/00</b> (2006.01)	P20231683	SINERGIJSKI UČINKOVIT HERBICIDNI SASTAV KOJI SADRŽI PELARGONSKU KISELINU I FLAZASULFURON
ChemoMouthpiece, LLC, US	<b>A61F 7/10</b> (2006.01) <b>A61C 19/06</b> (2006.01) <b>A61C 19/08</b> (2006.01) <b>A61F 7/12</b> (2006.01) <b>A61C 1/00</b> (2006.01) <b>A61F 7/00</b> (2006.01) <b>A61F 7/02</b> (2006.01)	P20231703	USNIK ZA HLAĐENJE TKIVA USNE ŠUPLJINE
Chiesi Farmaceutici S.p.A., IT	<b>A61K 9/00</b> (2006.01) <b>A61K 47/02</b> (2006.01) <b>A61K 47/10</b> (2017.01) <b>A61K 31/40</b> (2006.01) <b>A61K 31/573</b> (2006.01) <b>A61P 11/00</b> (2006.01) <b>A61P 43/00</b> (2006.01) <b>A61K 31/167</b> (2006.01)	P20231729	KOMBINIRANA TERAPIJA ZA KOPB
City of Hope, US	<b>C07K 7/00</b> (2006.01) <b>C07K 14/00</b> (2006.01) <b>C07K 16/00</b> (2006.01) <b>C07K 17/00</b> (2006.01) <b>C07H 21/00</b> (2006.01) <b>G01N 33/543</b> (2006.01) <b>C40B 70/00</b> (2006.01) <b>B82Y 5/00</b> (2011.01)	P20231536	PLATFORME ZA PREGLED KEMIJSKI KODIRANIH PROSTORNO ADRESIRANIH BIBLIOTEKA
CNRS Centre National de la Recherche Scientifique, FR	<b>C07D 239/16</b> (2006.01) <b>C07D 239/12</b> (2006.01) <b>C07D 401/12</b> (2006.01) <b>C07D 403/12</b> (2006.01) <b>C07D 405/12</b> (2006.01) <b>C07D 413/12</b> (2006.01) <b>A61K 31/505</b> (2006.01) <b>A61P 31/14</b> (2006.01)	P20231571	DERIVATI FENIL/PIRIDIL-NH-FENIL/PIRIDIL ZA LIJEČENJE INFEKCIJA RNA VIRUSOM
Dairy Protein Cooperation Food B.V., NL	<b>A23C 19/028</b> (2006.01) <b>A23C 19/076</b> (2006.01) <b>A23C 19/02</b> (2006.01) <b>A23C 19/05</b> (2006.01) <b>A23C 9/142</b> (2006.01)	P20231649	NAČIN IZRADE KOZJEG SIRA FRANCUSKOG TIPRA
DECO MED SRL, IT	<b>A61F 2/12</b> (2006.01) <b>A61F 2/00</b> (2006.01)	P20231632	UREĐAJ ZA POHRANU, NAMIJENJEN ZA PROTEZU DOJKE PRILIKOM REKONSTRUKTIVNE KIRURGIJE DOJKE
Double Power Europe GmbH, DE	<b>G07D 11/12</b> (2019.01) <b>G07D 11/40</b> (2019.01) <b>B65H 31/10</b> (2006.01) <b>B65H 31/22</b> (2006.01) <b>B65H 31/26</b> (2006.01)	P20231552	UREĐAJ ZA PRIMANJE NOVČANICA
Eisai R&D Management Co., Ltd., JP	<b>A61K 9/10</b> (2006.01) <b>A61K 47/02</b> (2006.01) <b>A61K 31/47</b> (2006.01) <b>A61P 35/00</b> (2006.01) <b>A61P 43/00</b> (2006.01)	P20231692	POSTUPAK ZA SUZBIJANJE GORČINE DERIVATA KINOLINA

Nositelj patenta (73)	MKP (51)	Broj patenta (11)	Naziv izuma (54)
Eisenmann GmbH, DE	<b>B05B 16/20</b> (2018.01) <b>B05B 16/00</b> (2018.01)	P20231658	POSTROJENJE, MODUL ZA OBRADU I POSTUPAK ZA OBRADU PREDMETA
Eli Lilly and Company, US	<b>A61M 5/20</b> (2006.01) <b>A61M 5/28</b> (2006.01)	P20231575	AUTOMATSKI SISTEM ZA UBRIZGAVANJE
ELI LILLY AND COMPANY, US	<b>A61K 31/4439</b> (2006.01) <b>C07D 405/14</b> (2006.01) <b>A61P 3/10</b> (2006.01)	P20231586	AGONISTI RECEPTORA GLUKAGONU SLIČNOG PEPTIDA 1
Eli Lilly and Company, US	<b>A61K 31/444</b> (2006.01) <b>A61P 25/06</b> (2006.01)	P20231587	KRONIČNO NOĆNO DOZIRANJE LASMIDITANA RADI SPRJEČAVANJA MIGRENE
E.ON Digital Technology GmbH, DE ESCO Group LLC, US	<b>G08B 21/04</b> (2006.01) <b>E02F 9/28</b> (2006.01) <b>E02F 9/26</b> (2006.01)	P20231577 P20231666	UREDAJ I SUSTAV ZA NADZOR PACIJENATA BRAVA ZA TROŠNI SKLOP
FACC AG, AT	<b>B64D 11/02</b> (2006.01) <b>E06B 3/36</b> (2006.01) <b>E04H 1/12</b> (2006.01)	P20231589	PALUBNA TOALETNA KABINA
F. HOFFMANN - LA ROCHE AG, CH	<b>A61P 25/28</b> (2006.01) <b>C07D 498/04</b> (2006.01) <b>A61K 31/5365</b> (2006.01)	P20231663	BICIKLIČKI DERIVATI HETEROARILA
F. List GmbH, AT	<b>B32B 7/12</b> (2006.01) <b>B32B 15/082</b> (2006.01) <b>B32B 15/095</b> (2006.01) <b>B32B 15/098</b> (2006.01) <b>B32B 15/10</b> (2006.01) <b>B32B 15/20</b> (2006.01) <b>B32B 21/08</b> (2006.01) <b>B32B 21/10</b> (2006.01) <b>B32B 21/14</b> (2006.01) <b>B32B 3/12</b> (2006.01) <b>B32B 17/06</b> (2006.01) <b>B32B 38/08</b> (2006.01) <b>B32B 37/12</b> (2006.01)	P20231600	KOMPOZITNI ELEMENT KOJI SADRŽI POKROVNI SLOJ FURNIRA
FRIES PLANUNGS- UND MARKETINGGESELLSCHAFT m.b.H., AT	<b>B65D 21/02</b> (2006.01) <b>B65D 81/26</b> (2006.01) <b>B65D 1/22</b> (2006.01) <b>A47L 19/04</b> (2006.01)	P20231635	KUTIJA KOJU SE MOŽE NASLAGIVATI
Gat Therapeutics S.L., ES	<b>C07C 403/24</b> (2006.01) <b>A61K 31/22</b> (2006.01) <b>A61P 9/00</b> (2006.01)	P20231676	ESTERI AMARUCIAKSANTINA A I NJIHOVA UPOTREBA
GENENTECH, INC., US	<b>A61K 39/00</b> (2006.01) <b>A61K 39/395</b> (2006.01) <b>A61P 35/00</b> (2006.01) <b>G01N 33/53</b> (2006.01) <b>C07K 16/24</b> (2006.01)	P20231569	NOVA PROTUTIJELA PROTIV IL 13 I NJIHOVA UPOTREBA
Gerhard Rauch Ges.m.b.H., AT	<b>B44B 5/00</b> (2006.01) <b>B44B 5/02</b> (2006.01)	P20231738	UREDAJ ZA UTISKIVANJE FILMA
GILEAD SCIENCES, INC., US	<b>C07D 471/18</b> (2006.01) <b>A61P 31/18</b> (2006.01)	P20231654	SUPSTITUIRANI SPOJEVI PIRIDOTRIAZINA I NJIHOVE UPORABE
GlaxoSmithKline Biologicals SA, BE	<b>C12N 15/62</b> (2006.01) <b>C07K 14/33</b> (2006.01) <b>A61K 39/08</b> (2006.01) <b>A61K 39/00</b> (2006.01) <b>C07K 16/12</b> (2006.01) <b>C12N 15/70</b> (2006.01)	P20231749	IMUNOGENI PRIPRAVAK
Goodman Co., Ltd., JP	<b>A61M 25/10</b> (2013.01) <b>A61B 17/22</b> (2006.01)	P20231672	BALONSKI KATETER
Groupe Guillin, FR	<b>B65D 1/18</b> (2006.01) <b>B65D 1/48</b> (2006.01) <b>B65D 25/34</b> (2006.01) <b>B65D 43/02</b> (2006.01) <b>B65D 43/16</b> (2006.01) <b>B65D 75/22</b> (2006.01)	P20231725	DVOMATERIJALNO PAKIRANJE IZRAĐENOG OD PLASTIKE I KARTONA ILI DRUGOG BIOLOŠKOG MATERIJALA SA POKRIVAČEM
Haser, Franz Josef, DE	<b>F16B 12/16</b> (2006.01) <b>F16B 5/06</b> (2006.01) <b>F16B 5/02</b> (2006.01) <b>F16B 3/00</b> (2006.01)	P20231622	SREDSTVO ZA SPAJANJE I POSTUPAK SPAJANJA DVIJE KOMPONENTE
Hetero Labs Limited, IN	<b>C07J 63/00</b> (2006.01) <b>A61K 31/58</b> (2006.01) <b>A61P 31/18</b> (2006.01) <b>A61K 31/18</b> (2006.01)	P20231582	NOVI DERIVATI TRITERPENA KAO INHIBITORI HIV-A
Hewlett-Packard Development Company, L.P., US	<b>B41J 2/045</b> (2006.01)	P20231660	KOMPONENTA ZA ISPIS S NIZOM MEMORIJE S POMOĆU ISPREKIDANOG SIGNALA SATA
HiProMine S.A., PL	<b>A01K 67/033</b> (2006.01) <b>G05D 23/00</b> (2006.01)	P20231594	PROIZVODNA LINIJA S PROTOČNIM SUSTAVOM GRIJANJA I/ILI HLAĐENJA HRANE I GRIJANOM POVRŠINOM ZA RAZMNOŽAVANJE I/ILI UZGOJ INSEKATA, METODA UZGOJA INSEKATA I NJENA UPOTREBA

Nositelj patenta (73)	MKP (51)	Broj patenta (11)	Naziv izuma (54)
HiProMine S.A., PL	<b>A01K 67/033</b> (2006.01) <b>G05D 23/00</b> (2006.01)	P20231595	PROIZVODNA POVRŠINA SA SUSTAVOM PODNOG GRIJANJA I/ILI HLADENJA HRANE ZA INSEKTE, UPOTREBA PODNOG SUSTAVA I NAČIN UZGOJA INSEKATA POMOĆU NJEGA
H. Lundbeck A/S, DK	<b>C07D 295/205</b> (2006.01) <b>C07C 57/15</b> (2006.01) <b>A61P 29/00</b> (2006.01) <b>A61P 25/00</b> (2006.01) <b>A61K 31/496</b> (2006.01)	P20231697	KRISTALNI OBLIK MAGL INHIBITORA
Immatics Biotechnologies GmbH, DE	<b>A61K 39/00</b> (2006.01) <b>C07K 16/28</b> (2006.01) <b>A61P 35/00</b> (2006.01) <b>C07K 14/47</b> (2006.01)	P20231570	PEPTID ZA UPORABU U IMUNOTERAPIJI PROTIV NESITNOSTANIČNOG RAKA PLUĆA I SITNOSTANIČNOG RAKA PLUĆA
Immunocore Limited, GB	<b>C07K 14/725</b> (2006.01)	P20231645	T STANIČNI RECEPTORI
Incyte Corporation, US	<b>C07D 487/04</b> (2006.01) <b>A61P 35/00</b> (2006.01) <b>A61K 31/519</b> (2006.01) <b>C07D 403/04</b> (2006.01) <b>C07D 403/14</b> (2006.01)	P20231614	SPOJEVI PIROLOTRIAZINA KAO TAM INHIBITORI
Industrial Ceramic Linings B.V., NL	<b>F23M 7/00</b> (2006.01)	P20231601	IZOLACIJSKI UREĐAJ POKLOPCA PLAMENIKA ZA KOTAO I POSTUPAK ZA PROIZVODNJU TAKVOG UREĐAJA
Ingenieursbureau en Technische Handelsonderneming Autron B.V., NL	<b>F41J 11/00</b> (2009.01) <b>F41J 11/02</b> (2009.01) <b>F24F 110/65</b> (2018.01)	P20231585	ZATVORENA STRELJANA
Institut Curie, FR	<b>C07D 239/16</b> (2006.01) <b>C07D 239/12</b> (2006.01) <b>C07D 401/12</b> (2006.01) <b>C07D 403/12</b> (2006.01) <b>C07D 405/12</b> (2006.01) <b>C07D 413/12</b> (2006.01) <b>A61K 31/505</b> (2006.01) <b>A61P 31/14</b> (2006.01)	P20231571	DERIVATI FENIL/PIRIDIL-NH-FENIL/PIRIDIL ZA LIJEČENJE INFEKCIJA RNA VIRUSOM
Institute Of Organic Chemistry and Biochemistry AS CR, V.V.I., CZ	<b>A61K 31/404</b> (2006.01) <b>A61K 31/66</b> (2006.01) <b>A61K 31/7076</b> (2006.01) <b>A61P 35/00</b> (2006.01) <b>C07C 227/14</b> (2006.01) <b>C07D 209/10</b> (2006.01) <b>C07D 317/40</b> (2006.01) <b>C07F 9/06</b> (2006.01)	P20231163	PROLIJEKOVI GLUTAMINSKIH ANALOGA
Japan Tobacco, Inc., JP	<b>A61K 31/47</b> (2006.01) <b>A61P 31/18</b> (2006.01) <b>C07D 215/56</b> (2006.01)	P20231588	KOMBINACIJA KOJA SADRŽI STABILNI KRISTAL 4-OKSOKINOLINSKOG SPOJA
JOHN ENGINE SPORTS PRODUCTS INC, CN	<b>A41D 19/00</b> (2006.01) <b>A41D 19/015</b> (2006.01) <b>A41D 19/02</b> (2006.01) <b>B29D 99/00</b> (2010.01)	P20231647	STRUKTURA RUKAVICE
Kaival Labs, Inc., US	<b>A24F 40/48</b> (2020.01) <b>A24F 40/485</b> (2020.01) <b>A24F 40/10</b> (2020.01) <b>A61M 15/00</b> (2006.01) <b>A61M 15/06</b> (2006.01) <b>A61M 11/04</b> (2006.01) <b>G01F 11/02</b> (2006.01) <b>G16H 20/13</b> (2018.01)	P20231605	PATRONA I POSTUPAK ISPARAVANJA U SUSTAVU PATRONA S DIFUZOROM
Klingmill AB, SE	<b>B02C 18/14</b> (2006.01) <b>B02C 18/18</b> (2006.01) <b>B02C 18/20</b> (2006.01) <b>B23D 61/02</b> (2006.01)	P20231625	UREĐAJ ZA USITNJAVANJE MATERIJALA UKLJUČUJUĆI STACIONARNO KUĆIŠTE I METODU ZA PROIZVODNJU STACIONARNOG KUĆIŠTA
Koffie F. Rombouts, Naamloze Vennootschap, BE	<b>B65D 85/804</b> (2006.01) <b>A47J 31/02</b> (2006.01)	P20231551	FILTER ZA PRIPREMU KAVE ILI INFUZIJE
K.W.H. Ciclosport Vertriebs GmbH, DE	<b>G01P 3/487</b> (2006.01) <b>G01P 3/66</b> (2006.01)	P20231607	UREĐAJ ZA DOBIVANJE PODATAKA IZ KOJIH SE ODREĐUJE BRZINU VOZILA, NAPRAVA ZA PROCJENJIVANJE I ODGOVARAJUĆI POSTUPAK
Lacuna S.A., UY	<b>A45D 24/30</b> (2006.01)	P20231646	ČEŠALJ ZA LIJEČENJE PEDIKULOZE
Lamello AG, CH	<b>F16B 12/16</b> (2006.01) <b>F16B 5/06</b> (2006.01) <b>F16B 5/02</b> (2006.01) <b>F16B 3/00</b> (2006.01)	P20231622	SREDSTVO ZA SPAJANJE I POSTUPAK SPAJANJA DVIJE KOMPONENTE
Led-Arena GmbH, DE	<b>E04F 19/08</b> (2006.01) <b>H02G 3/08</b> (2006.01)	P20231724	UREĐAJ S OTVOROM ZA INSPEKCIJU

Nositelj patenta (73)	MKP (51)	Broj patenta (11)	Naziv izuma (54)
Legend Biotech Ireland Limited, IE	<b>C07K 19/00</b> (2006.01) <b>C12N 5/10</b> (2006.01) <b>A61K 39/395</b> (2006.01) <b>A61P 35/00</b> (2006.01) <b>A61P 35/02</b> (2006.01) <b>C07K 14/725</b> (2006.01) <b>C07K 14/705</b> (2006.01) <b>C07K 16/28</b> (2006.01) <b>C07K 16/30</b> (2006.01) <b>C12N 15/62</b> (2006.01) <b>A61P 7/00</b> (2006.01) <b>C07K 14/435</b> (2006.01)	P20231542	KIMERNI ANTIGENSKI RECEPTORI KOJI CILJAJU BCMA I POSTUPCI NJIHOVE UPORABE
Leistriz Turbinentechnik Nürnberg GmbH, DE	<b>B23H 9/10</b> (2006.01) <b>B23H 3/04</b> (2006.01) <b>B23H 11/00</b> (2006.01)	P20231545	POSTUPAK I UREĐAJ ZA PROIZVODNJU METALNE KOMPONENTE, NAROČITO KOMPONENTE LOPATICE TURBOSTROJA
Les Laboratoires Servier, FR	<b>C07D 401/12</b> (2006.01) <b>C07D 401/14</b> (2006.01)	P20231618	POSTUPAK ZA PRIPREMU IVOSIDENIBA I NJEGOVOG INTERMEDIJARA
LG Electronics Inc., KR	<b>H04N 19/159</b> (2014.01) <b>H04N 19/18</b> (2014.01) <b>H04N 19/132</b> (2014.01) <b>H04N 19/12</b> (2014.01)	P20231634	TRANSFORMACIJA NAMIJENJENA UNUTARNJEM PREDVIĐANJU NA TEMELJU MATRICE PRILIKOM KODIRANJA SLIKE
LG Electronics Inc., KR	<b>H04N 19/105</b> (2014.01) <b>H04N 19/513</b> (2014.01) <b>H04N 19/132</b> (2014.01) <b>H04N 19/176</b> (2014.01) <b>H04N 19/70</b> (2014.01) <b>H04N 19/174</b> (2014.01)	P20231695	POSTUPAK KODIRANJA SLIKE NA TEMELJU POVIJESTI
LG Electronics, Inc., KR	<b>H04N 19/70</b> (2014.01) <b>H04N 19/593</b> (2014.01)	P20231580	POSTUPAK ZA DIJELJENJE BLOKA I UREĐAJ ZA DEKODIRANJE
LG Electronics, Inc., KR	<b>H04N 19/52</b> (2014.01)	P20231669	INTER PREDIKCIJA
Lignum Technologies AG, CH	<b>B44C 5/04</b> (2006.01)	P20231688	PVC PLASTIČNA PLOČA
Ludwig Institute for Cancer Research Ltd, CH	<b>C07K 16/28</b> (2006.01) <b>A61K 39/00</b> (2006.01) <b>A61P 11/00</b> (2006.01) <b>A61P 35/04</b> (2006.01)	P20231579	ANTI-CTLA-4 ANTITIJELA I POSTUPCI NJIHOVE UPOTREBE
Lummus Technology LLC, US	<b>F28F 9/02</b> (2006.01) <b>F28F 27/00</b> (2006.01) <b>F16J 15/02</b> (2006.01) <b>F28D 7/16</b> (2006.01)	P20231626	SKLOPOVI ZA ZATVARANJE IZMJENJIVAČA TOPLINE I POSTUPCI NJIHOVE UPOTREBE I UGRADNJE
Lupin Limited, IN	<b>C07D 471/04</b> (2006.01) <b>A61K 31/519</b> (2006.01) <b>A61P 35/00</b> (2006.01)	P20231673	INHIBITORI PRMT5
MedinCell S.A., FR	<b>A61K 47/34</b> (2017.01) <b>A61K 9/00</b> (2006.01) <b>A61K 31/445</b> (2006.01)	P20231667	FARMACEUTSKI PRIPRAVAK
Megajoint. Co., Ltd., KR	<b>B25B 27/02</b> (2006.01) <b>B25B 5/14</b> (2006.01) <b>B25B 27/10</b> (2006.01) <b>B21D 39/04</b> (2006.01) <b>F16L 13/14</b> (2006.01)	P20231700	NAPRAVA ZA HVATANJE PREDMETA I ALAT ZA PRIČVRŠĆIVANJE CIJEVNOG SPOJA
Memorial Sloan Kettering Cancer Center, US	<b>C07K 16/28</b> (2006.01) <b>A61K 39/00</b> (2006.01) <b>A61P 11/00</b> (2006.01) <b>A61P 35/04</b> (2006.01)	P20231579	ANTI-CTLA-4 ANTITIJELA I POSTUPCI NJIHOVE UPOTREBE
Memo Therapeutics AG, CH	<b>C07K 16/08</b> (2006.01) <b>A61P 13/12</b> (2006.01) <b>A61P 31/12</b> (2006.01) <b>A61P 31/20</b> (2006.01) <b>A61P 37/06</b> (2006.01)	P20231739	MOLEKULE ANTITIJELA VIRUSA ANTI-BK
Merck Patent GmbH, DE	<b>C07D 403/12</b> (2006.01) <b>C07D 401/14</b> (2006.01) <b>C07D 405/14</b> (2006.01) <b>C07D 413/14</b> (2006.01) <b>A61K 31/4418</b> (2006.01) <b>A61K 31/505</b> (2006.01) <b>A61K 31/506</b> (2006.01) <b>A61K 31/513</b> (2006.01) <b>A61K 31/5377</b> (2006.01) <b>A61K 31/55</b> (2006.01) <b>C07D 401/04</b> (2006.01) <b>C07D 403/14</b> (2006.01) <b>C07D 413/12</b> (2006.01) <b>C07D 495/04</b> (2006.01) <b>A61P 25/28</b> (2006.01)	P20231547	POSTUPCI LIJEČENJA MULTIPLE SKLEROZE PRIMJENOM SPOJEVA PIRIMIDINA I PIRIDINA S AKTIVNOŠĆU INHIBICIJE BTK

Nositelj patenta (73)	MKP (51)	Broj patenta (11)	Naziv izuma (54)
Merck Patent GmbH, DE	<b>A61K 9/16</b> (2006.01) <b>A61K 9/20</b> (2006.01) <b>A61K 9/48</b> (2006.01) <b>A61K 31/506</b> (2006.01) <b>A61P 35/00</b> (2006.01)	P20231548	FARMACEUTSKI PRIPRAVAK
Merck Patent GmbH, DE	<b>C07D 413/14</b> (2006.01) <b>A61K 9/14</b> (2006.01) <b>A61K 9/20</b> (2006.01) <b>A61P 35/00</b> (2006.01)	P20231748	FARMACEUTSKA FORMULACIJA
Messerle, Heiner, AT	<b>B65D 5/20</b> (2006.01) <b>B65D 5/24</b> (2006.01) <b>B65D 5/68</b> (2006.01)	P20231573	AMBALAŽA
METTEN Technologies GmbH & Co. KG, DE	<b>C04B 28/00</b> (2006.01) <b>C04B 28/02</b> (2006.01) <b>C04B 28/08</b> (2006.01) <b>C04B 28/12</b> (2006.01) <b>C04B 28/14</b> (2006.01) <b>C04B 28/26</b> (2006.01) <b>B28B 1/00</b> (2006.01) <b>B28B 13/02</b> (2006.01)	P20231554	BETONSKI ELEMENT I POSTUPAK NJEGOVE PROIZVODNJE
Meyer Burger (Germany) GmbH, DE	<b>H01L 31/0224</b> (2006.01) <b>H01L 31/0747</b> (2012.01)	P20231741	FOTONAPONSKI UREĐAJ I POSTUPAK NJEGOVE PROIZVODNJE
MÜPRO Services GmbH, DE	<b>F16B 7/18</b> (2006.01) <b>F16B 37/04</b> (2006.01)	P20231689	SKLOP ZA PRIČVRŠĆIVANJE
Neuroderm Ltd., IL	<b>A61K 9/00</b> (2006.01) <b>A61K 47/18</b> (2017.01) <b>A61K 47/20</b> (2006.01) <b>A61K 47/22</b> (2006.01) <b>A61K 31/198</b> (2006.01) <b>A61K 31/133</b> (2006.01) <b>A61P 25/16</b> (2006.01)	P20231716	PRIPRAVCI INHIBITORA DOPA DEKARBOKSILAZE
Nicoventures Trading Limited, GB	<b>A24B 15/00</b> (2006.01)	P20231665	STVARANJE AEROSOLA
Nicoventures Trading Limited, GB	<b>A24B 15/00</b> (2006.01)	P20231698	GENERIRANJE AEROSOLA
Nodthera Limited, GB	<b>C07D 307/87</b> (2006.01) <b>C07D 231/12</b> (2006.01) <b>C07D 241/12</b> (2006.01) <b>C07D 249/08</b> (2006.01) <b>C07D 233/56</b> (2006.01) <b>C07D 237/08</b> (2006.01) <b>C07D 239/26</b> (2006.01) <b>A61K 31/343</b> (2006.01) <b>A61K 31/415</b> (2006.01) <b>A61K 31/4164</b> (2006.01) <b>A61K 31/4965</b> (2006.01) <b>A61P 29/00</b> (2006.01) <b>A61P 37/00</b> (2006.01)	P20231690	SELEKTIVNI INHIBITORI NLRP3 INFLAMASOMA
Novartis AG, CH	<b>A61P 35/00</b> (2006.01) <b>A61K 31/4747</b> (2006.01) <b>C07D 487/10</b> (2006.01)	P20231734	TRICIČLIČKI AKR1C3 OVISNI KARS INHIBITORI
Nova Siria S.r.l., IT	<b>F16L 55/17</b> (2006.01) <b>F16L 55/172</b> (2006.01) <b>F16J 15/06</b> (2006.01)	P20231627	SPOJNICA ZA POPRAVAK ZA POPRAVAK CJEVOVODA KOJIM MOŽE PROTJECATI TEKUĆINA I ODGOVARAJUĆA METODA
Novo Nordisk A/S, DK	<b>A61K 31/609</b> (2006.01) <b>A61K 38/26</b> (2006.01) <b>A61K 9/20</b> (2006.01) <b>A61P 3/00</b> (2006.01) <b>A61P 3/04</b> (2006.01) <b>A61P 3/10</b> (2006.01)	P20231613	PRIPRAVCI KOJI SADRŽE SREDSTVO ZA UNOŠENJE I NJIHOVA PRIPRAVA
N.V. Nutricia, NL	<b>A61K 31/04</b> (2006.01) <b>A61K 31/202</b> (2006.01) <b>A61K 31/375</b> (2006.01) <b>A61K 31/7068</b> (2006.01) <b>A61K 31/7072</b> (2006.01) <b>A61P 25/28</b> (2006.01) <b>A61P 3/02</b> (2006.01)	P20231584	POSTUPAK ZA PODRŠKU MEMORIJSKOJ FUNKCIJI I/ILI KOGNITIVNOJ FUNKCIJI
OGEDA N.V., BE	<b>A61P 3/04</b> (2006.01) <b>A61K 31/472</b> (2006.01) <b>A61K 31/4725</b> (2006.01) <b>A61K 31/495</b> (2006.01) <b>A61K 31/4985</b> (2006.01)	P20231661	ANTAGONISTI NK-3 RECEPTORA ZA TERAPIJSKO ILI KOZMETIČKO LIJEČENJE VIŠKA TJELESNE MASTI
Orion Corporation, FI	<b>A61K 9/08</b> (2006.01) <b>A61K 31/4045</b> (2006.01) <b>A61P 1/00</b> (2006.01)	P20231653	STABILNI FARMACEUTSKI SASTAVI ROPINIROLA
Otolanum AG, CH	<b>A61K 31/4402</b> (2006.01) <b>A61P 27/16</b> (2006.01) <b>A61K 47/32</b> (2006.01) <b>A61K 9/08</b> (2006.01)	P20231706	INTRANAZALNI PRIPRAVAK KOJI SADRŽI BETAHISTIN

Nositelj patenta (73)	MKP (51)	Broj patenta (11)	Naziv izuma (54)
Otsuka Pharmaceutical Co., Ltd., JP	<b>C07D 223/16</b> (2006.01) <b>C07D 401/14</b> (2006.01) <b>C07D 401/06</b> (2006.01) <b>C07D 401/10</b> (2006.01) <b>C07D 403/06</b> (2006.01) <b>C07D 405/12</b> (2006.01) <b>C07D 409/12</b> (2006.01) <b>A61P 13/12</b> (2006.01) <b>A61K 31/55</b> (2006.01)	P20231616	DERIVATI BENZAZEPINA
Period Pill BV, NL	<b>A61K 31/137</b> (2006.01) <b>A61P 15/00</b> (2006.01) <b>A61P 25/00</b> (2006.01)	P20231735	LIJEČENJE SIMPTOMA IZAZVANIH MENSTRUALNIM CIKLUSOM
PharmaEssentia Corporation, TW	<b>A61K 38/21</b> (2006.01) <b>A61K 47/60</b> (2017.01) <b>A61P 35/00</b> (2006.01) <b>A61P 7/00</b> (2006.01) <b>A61P 19/00</b> (2006.01) <b>A61P 19/04</b> (2006.01) <b>A61P 19/08</b> (2006.01) <b>A61P 31/00</b> (2006.01) <b>A61P 35/02</b> (2006.01)	P20231732	REŽIM DOZIRANJA PEGILIRANOG INTERFERONA
Pozigun, Dmytro, UA	<b>C07D 243/24</b> (2006.01) <b>A61K 31/5513</b> (2006.01) <b>A61P 25/02</b> (2006.01)	P20231538	FARMACEUTSKI SPOJ, POSTUPAK ZA NJEGOVU IZRADU I UPORABA KAO LIJEKOVITOG SREDSTVA
Reder, Anatoliy, UA	<b>C07D 243/24</b> (2006.01) <b>A61K 31/5513</b> (2006.01) <b>A61P 25/02</b> (2006.01)	P20231538	FARMACEUTSKI SPOJ, POSTUPAK ZA NJEGOVU IZRADU I UPORABA KAO LIJEKOVITOG SREDSTVA
Regeneron Pharmaceuticals, Inc., US	<b>A01K 67/0278</b> (2024.01) <b>G01N 33/50</b> (2006.01) <b>C07K 14/705</b> (2006.01) <b>C07K 16/28</b> (2006.01) <b>A61P 35/00</b> (2006.01) <b>C07K 14/47</b> (2006.01)	P20231707	ŽIVOTINJE KOJE NISU LJUDI, KOJE SADRŽE HUMANIZIRANI GEN IZ DIFERENCIJACIJSKE SKUPINE 47
Reil, Goran, US	<b>A61B 17/00</b> (2006.01) <b>A44C 7/00</b> (2006.01)	P20231659	JEDNOKRATNI RUČNI ULOŽAK INSTRUMENTA ZA PROBIJANJE TIJELA
Rhombus Systems Group, Inc., US	<b>G06F 21/57</b> (2013.01) <b>G06F 7/00</b> (2006.01) <b>B64C 39/02</b> (2023.01) <b>G05D 1/00</b> (2024.01) <b>H04L 67/125</b> (2022.01) <b>G06F 21/64</b> (2013.01) <b>G06F 21/44</b> (2013.01) <b>H04L 9/40</b> (2022.01) <b>H04W 12/10</b> (2021.01) <b>F28D 20/00</b> (2006.01)	P20231656	SUSTAV ZA PROVJERU CJELOVITOSTI BESPILOTNIH LETJELICA
RK Projektentwicklungs- und Beteiligungs GmbH, AT	<b>A61K 47/32</b> (2006.01) <b>A61P 35/00</b> (2006.01) <b>C08F 222/10</b> (2006.01)	P20231642	KONJUGATI POLIMER-LIJEK KOJI SE MOGU CIJEPATI
RS Arastirma Egitim Danismanlik Ilac Sanayi Ticaret Anonim Sirketi, TR	<b>H04L 65/70</b> (2022.01) <b>H04N 21/854</b> (2011.01) <b>H04L 65/612</b> (2022.01)	P20231610	POSTUPAK ZA PRIJENOS I PRIJAM MEDIJSKIH PODATAKA
Samsung Electronics Co., Ltd., KR	<b>E04F 17/02</b> (2006.01) <b>E04F 17/04</b> (2006.01) <b>E04F 19/00</b> (2006.01)	P20231530	SPOJNICA ZA ROGOVE I PRIČVRSNI SUSTAV KOJI SE SASTOJI OD SPOJNICE ZA ROGOVE I BOČNIH NOSAČA ZA DRŽANJE OKOMITIH CIJEVI KAO ŠTO SU DIMNJACI
Schiedel GmbH, AT	<b>F41A 9/69</b> (2006.01)	P20231590	KUĆIŠTE OKVIRA ZA STRELJIVO ZA RUČNO VATRENO ORUŽJE I OKVIR ZA STRELJIVO ZA RUČNO VATRENO ORUŽJE
Schmeisser GmbH, DE	<b>A61K 31/198</b> (2006.01) <b>A61K 31/205</b> (2006.01) <b>A61K 45/06</b> (2006.01) <b>A61K 31/277</b> (2006.01) <b>A61P 3/02</b> (2006.01) <b>A61P 3/04</b> (2006.01) <b>A61P 3/06</b> (2006.01) <b>A61P 3/08</b> (2006.01) <b>A61P 3/10</b> (2006.01)	P20231572	POSTUPCI I PRIPRAVCI ZA LIJEČENJE PRETILOSTI, SPREČAVANJE DOBIVANJA NA TEŽINI, PROMICANJE GUBITKA TEŽINE, PROMICANJE MRŠAVLJENJA, ILI LIJEČENJE ILI PREVENCIJU RAZVOJA DIJABETESA
Silti AG, CH	<b>B65B 7/28</b> (2006.01) <b>B65B 7/16</b> (2006.01) <b>B65B 47/00</b> (2006.01) <b>B65B 51/02</b> (2006.01) <b>B65B 55/24</b> (2006.01) <b>B65B 57/06</b> (2006.01) <b>B65B 61/00</b> (2006.01) <b>B65D 77/20</b> (2006.01)	P20231651	POSTUPAK PROIZVODNJE SPREMNIKA ZA PREHRAMBENE PROIZVODE
Siropack Italia S.r.l., IT			

Nositelj patenta (73)	MKP (51)	Broj patenta (11)	Naziv izuma (54)
Skiba, Mohamed, FR	<b>A61K 31/03</b> (2006.01) <b>A61K 9/107</b> (2006.01) <b>A61K 9/16</b> (2006.01) <b>A61P 35/00</b> (2006.01) <b>A61K 9/14</b> (2006.01)	P20231641	FARMACEUTSKI PRIPRAVAK KOJI SADRŽI MITOTAN ZA ORALNU PRIMJENU ZA LIJEČENJE ADRENOKORTIKALNOG KARCINOMA I CUSHINGOVOG SINDROMA
SodaStream Industries Ltd., IL	<b>F16K 1/02</b> (2006.01) <b>F17C 1/00</b> (2006.01) <b>B01F 23/00</b> (2022.01)	P20231624	ADAPTER GLAVE ZA PUNJENJE ZA STROJ ZA KARBONIZACIJU
Stoke Therapeutics, Inc., US	<b>C12N 15/11</b> (2006.01) <b>C07K 14/705</b> (2006.01) <b>C12Q 1/6883</b> (2018.01)	P20231637	ANTISENS OLIGOMERI ZA LIJEČENJE STANJA I BOLESTI
Strathmann GmbH & Co. KG, DE	<b>A61K 31/721</b> (2006.01)	P20231644	IMUNOPROFILAKSA PONAVLJANIH BAKTERIJSKIH INFEKCIJA
Stropus Ltd., CY	<b>A63F 1/14</b> (2006.01) <b>A63F 1/06</b> (2006.01)	P20231674	CIPELA DJELITELJA KARATA S GURAČEM
Sunreef Venture S.A., PL	<b>B63B 15/00</b> (2006.01)	P20231603	OKOMITA KOMPONENTA SNASTI, OSOBITO JARBOL PLOVILA, I POSTUPAK NJEGOVE PROIZVODNJE
Syngenta Participations AG, CH	<b>A01N 25/28</b> (2006.01) <b>A01N 53/00</b> (2006.01) <b>A01P 7/04</b> (2006.01)	P20231633	MIKROKAPSULE KOJE INKAPSULIRAJU LAMBDA-CIHALOTRIN
Takeda Vaccines, Inc., US	<b>A61K 39/12</b> (2006.01)	P20231581	PRIPRAVCI I POSTUPCI ZA KIMERNE KONSTRUKTE VIRUSA DENGA GROZNICE U CJEPIVIMA
Tarasov, Mark, RU	<b>G01S 13/88</b> (2006.01) <b>G01S 7/03</b> (2006.01) <b>H05B 6/70</b> (2006.01) <b>H03B 1/04</b> (2006.01) <b>H03B 9/10</b> (2006.01)	P20231596	MIKROVALNI OSCILATOR I MIKROVALNI OSCILATOR MATRIČNOG TIPA UTEMELJEN NA NJEMU
The Chinese University Of Hong Kong, CN	<b>G16B 20/00</b> (2019.01) <b>G16B 20/10</b> (2019.01)	P20231604	NEINVAZIVNO PRENATALNO MOLEKULSKO KARIOTIPIZIRANJE IZ MAJČINSKE PLAZME
The Government of The United States of America as represented by The Secretary of The Department of Health and Human Services, US	<b>A61K 39/12</b> (2006.01)	P20231581	PRIPRAVCI I POSTUPCI ZA KIMERNE KONSTRUKTE VIRUSA DENGA GROZNICE U CJEPIVIMA
The Johns Hopkins University, US	<b>A61K 31/404</b> (2006.01) <b>A61K 31/66</b> (2006.01) <b>A61K 31/7076</b> (2006.01) <b>A61P 35/00</b> (2006.01) <b>C07C 227/14</b> (2006.01) <b>C07D 209/10</b> (2006.01) <b>C07D 317/40</b> (2006.01) <b>C07F 9/06</b> (2006.01)	P20231163	PROLIJEKOVI GLUTAMINSKIH ANALOGA
The Trustees of Columbia University in the City of New York, US	<b>C07D 495/04</b> (2006.01) <b>A61K 31/5025</b> (2006.01) <b>A61P 9/10</b> (2006.01) <b>A61P 17/00</b> (2006.01) <b>A61P 13/12</b> (2006.01) <b>A61Q 19/08</b> (2006.01)	P20231563	4-OKSO-3,4-DIHIDROTINO[3,4-D]PIRIDAZINSKI SPOJEVI KAO INHIBITORI ALDOSOREDUKTAZE I NAČINI NJIHOVE UPOTREBE
The University Court Of The University of Edinburgh, GB	<b>G01N 33/68</b> (2006.01)	P20231592	ISPITIVANJE DETEKCIJE ALFA-SINUKLEINA I POSTUPAK DIJAGNOSTICIRANJA ALFA-SINUKLEINOPATIJE
TRON - Translationale Onkologie an der Universitätsmedizin der Johannes Gutenberg- Universität Mainz gemeinnützige GmbH, DE	<b>A61P 35/00</b> (2006.01) <b>A61P 35/04</b> (2006.01) <b>A61P 37/04</b> (2006.01) <b>C12N 15/113</b> (2010.01) <b>A61K 31/7088</b> (2006.01)	P20231525	POSTUPCI I PRIPRAVCI ZA DIJAGNOZU I LIJEČENJE RAKA
TRON - Translationale Onkologie an der Universitätsmedizin der Johannes Gutenberg- Universität Mainz gemeinnützige GmbH, DE	<b>C07K 16/28</b> (2006.01) <b>C07K 16/30</b> (2006.01) <b>A61K 47/68</b> (2017.01) <b>A61P 35/00</b> (2006.01) <b>A61K 31/40</b> (2006.01)	P20231609	KONJUGATI LIJEKA KOJI SADRŽE ANTITIJELA PROTIV KLAUDINA 18.2
Universität Bern, CH	<b>C07K 16/08</b> (2006.01) <b>A61P 13/12</b> (2006.01) <b>A61P 31/12</b> (2006.01) <b>A61P 31/20</b> (2006.01) <b>A61P 37/06</b> (2006.01)	P20231739	MOLEKULE ANTITIJELA VIRUSA ANTI-BK
Universität Zürich, CH	<b>C07K 16/08</b> (2006.01) <b>A61P 13/12</b> (2006.01) <b>A61P 31/12</b> (2006.01) <b>A61P 31/20</b> (2006.01) <b>A61P 37/06</b> (2006.01)	P20231739	MOLEKULE ANTITIJELA VIRUSA ANTI-BK
Université Côte d'Azur, FR	<b>C07K 14/72</b> (2006.01) <b>A61K 38/08</b> (2019.01) <b>A61K 38/10</b> (2006.01) <b>C07K 7/06</b> (2006.01) <b>C07K 7/08</b> (2006.01)	P20231567	PEPTIDI IZVEDENI IZ PROPEPTIDA NTSR3 I NJIHOVA UPORABA U LIJEČENJU DEPRESIJE



Nositelj patenta (73)	MKP (51)	Broj patenta (11)	Naziv izuma (54)
Universite de Montpellier, FR	<b>C07D 239/16</b> (2006.01) <b>C07D 239/12</b> (2006.01) <b>C07D 401/12</b> (2006.01) <b>C07D 403/12</b> (2006.01) <b>C07D 405/12</b> (2006.01) <b>C07D 413/12</b> (2006.01) <b>A61K 31/505</b> (2006.01) <b>A61P 31/14</b> (2006.01)	P20231571	DERIVATI FENIL/PIRIDIL-NH-FENIL/PIRIDIL ZA LIJEČENJE INFEKCIJA RNA VIRUSOM
VEGA Grieshaber KG, DE	<b>G01F 23/80</b> (2022.01) <b>G01F 23/284</b> (2006.01) <b>G01F 23/14</b> (2006.01) <b>G01F 23/24</b> (2006.01) <b>G01F 23/26</b> (2022.01)	P20231593	UREĐAJ ZA MJERENJE RAZINE PUNJENJA KORIŠTENJEM SENZORA RAZINE PUNJENJA KOJI KONTINUIRANO MJERI I POSTUPAK ZA RUKOVANJE TAKVIM UREĐAJEM ZA MJERENJE RAZINE PUNJENJA
Vertex Pharmaceuticals Incorporated, US	<b>A61P 11/00</b> (2006.01) <b>C07D 239/69</b> (2006.01) <b>C07D 515/08</b> (2006.01)	P20231639	MODULACIJSKA SREDSTVA TRANSMEMBRANSKOG REGULATORA PROVODLJIVOSTI CISTIČNE FIBROZE
Visterra, Inc., US	<b>C07K 16/28</b> (2006.01) <b>A61K 39/395</b> (2006.01) <b>A61K 39/00</b> (2006.01)	P20231578	MOLEKULE PROTUTIJELA NA APRIL I NJIHOVE UPORABE
VMR Products, LLC, US	<b>A24F 40/42</b> (2020.01) <b>A61M 15/06</b> (2006.01) <b>A61M 11/04</b> (2006.01) <b>H02J 7/00</b> (2006.01) <b>A24F 40/90</b> (2020.01) <b>A24F 40/40</b> (2020.01) <b>A24F 40/50</b> (2020.01) <b>A24F 40/10</b> (2020.01)	P20231696	VAPORIZATOR
WuXi Biologics Ireland Limited, IE	<b>C12N 15/09</b> (2006.01) <b>C07K 16/28</b> (2006.01) <b>C12N 5/00</b> (2006.01) <b>A61K 39/395</b> (2006.01) <b>C12P 21/08</b> (2006.01) <b>A61P 31/12</b> (2006.01) <b>A61P 35/00</b> (2006.01) <b>A61P 37/04</b> (2006.01)	P20231664	NOVA ANTI-PD-L1 ANTITIJELA
WuXi Biologics (Shanghai) Co., Ltd., CN	<b>C12N 15/09</b> (2006.01) <b>C07K 16/28</b> (2006.01) <b>C12N 5/00</b> (2006.01) <b>A61K 39/395</b> (2006.01) <b>C12P 21/08</b> (2006.01) <b>A61P 31/12</b> (2006.01) <b>A61P 35/00</b> (2006.01) <b>A61P 37/04</b> (2006.01)	P20231664	NOVA ANTI-PD-L1 ANTITIJELA
Wyeth LLC, US	<b>C07K 14/33</b> (2006.01) <b>A61K 39/08</b> (2006.01) <b>C07K 16/12</b> (2006.01)	P20231631	PRIPRAVCI KOJI SE ODOSE NA MUTANTNI TOKSIN IZ BAKTERIJE CLOSTRIDIUM DIFFICILE I ODGOVARAJUĆI POSTUPCI
X-Pole Asia Limited, CN	<b>A63B 71/02</b> (2006.01)	P20231712	SKLOP ZA ŠIPKU ZA PLESNE VJEŽBE
Ymer Technology AB, SE	<b>B60H 1/00</b> (2006.01) <b>B60H 1/14</b> (2006.01) <b>B60H 1/22</b> (2006.01)	P20231723	SUSTAV REGULACIJE TOPLINE I ELEKTRIČNO VOZILO KOJE UKLJUČUJE SUSTAV REGULACIJE TOPLINE
Yuhan Corporation, KR	<b>A61K 9/20</b> (2006.01) <b>A61K 31/5377</b> (2006.01)	P20231670	FARMACEUTSKI PRIPRAVAK ZA ORALNU PRIMJENU KOJI SADRŽI DERIVAT AMINOPIRIMIDINA ILI NJEGOVU SOL

# Objava izmijenjenih prijevoda europskih patenata

- 
- (51) MKP (10) [HR P20201294 T4](#)  
**B65D 85/804** (2006.01)
- (11) P20201294 (46) 15.03.2024.  
(21) P20201294T (22) 19.08.2020.
- (86) PCT/EP2017066132 29.06.2017.  
(96) [EP 17734297.9](#) 29.06.2017.  
(87) [WO2018002223](#), 04.01.2018., De  
(97) EP 3400184, 14.11.2018. 201846, De  
(97) EP 3400184, 22.07.2020. 202030, De
- (31) 102016112135 (32) 01.07.2016. (33) DE
- (54) **SPREMNIK ZA PRIPREMU NAPITAKA**  
PORTION CONTAINER FOR EXTRACTABLE SUBSTANCES FOR PRODUCING A BEVERAGE
- (73) BBC Bremer Bagasse Company GmbH & Co. KG, Auf den Kamp 1, 27721 Ritterhude, MU
- (72) David Wolf-Rooney, Steindamm 37, 28719 Bremen, DE
- (74) PRODUCTA d.o.o., Zagreb, HR
- 

- (51) MKP (10) [HR P20131090 T4](#)  
**C07H 19/06** (2006.01)  
**A61K 31/7068** (2006.01)  
**A61P 35/00** (2006.01)
- (11) P20131090 (46) 15.03.2024.  
(21) P20131090T (22) 14.11.2013.
- (86) PCT/JP2010003261 14.05.2010.  
(96) [EP 10774734.7](#) 14.05.2010.  
(87) [WO2010131475](#), 18.11.2010.  
(97) EP 2431376, 21.03.2012. 201212, En  
(97) EP 2431376, 14.08.2013. 201333, En
- (31) 2009118726 (32) 15.05.2009. (33) JP
- (54) **NOVI STABILNI KRISTALI 1-(2'-CIJANO-2'-DEOKSI-β-D-ARABINOFURANOZIL) CITOZIN MONOHIDROKLORIDA**  
NOVEL STABLE CRYSTAL OF 1-(2'-CYANO-2'-DEOXY-BETA -D-ARABINOFURANOSYL)CYTOSINE MONOHYDROCHLORIDE
- (73) Delta-Fly Pharma, Inc., 37-2, Nishikino, Miyajima Kawauchi-cho, Tokushima-shi, 771-0116 Tokushima, JP
- (72) Shotaro Watanabe, c/o Taiho Pharmaceutical Co., Ltd 200-22, Oaza Motohara Kamikawa-machi, Kodama-gun, 367-0241 Saitama, JP  
Takahiro Hatakeyama, c/o Taiho Pharmaceutical Co., Ltd 200-22, Oaza Motohara Kamikawa-machi, Kodama-gun, 367-0241 Saitama, JP
- (74) PETOŠEVIĆ d.o.o., Zagreb, HR
-

# Kazalo brojeva izmijenjenih prijevoda europskih patenata

Broj patenta (11)	MKP (51)	Broj patenta (11)	MKP (51)
P20131090	<b>C07H 19/06</b> (2006.01) <b>A61K 31/7068</b> (2006.01) <b>A61P 35/00</b> (2006.01)	P20201294	<b>B65D 85/804</b> (2006.01)

# Kazalo klasifikacijskih oznaka izmijenjenih prijevoda europskih patenata prema Međunarodnoj klasifikaciji патената

MKP (51)	Broj патената (11)	Naziv izuma (54)
<b>A61K 31/7068</b> (2006.01)	P20131090	NOVI STABILNI KRISTALI 1-(2'-CIJANO-2'-DEOKSI-β-D-ARABINOFURANOZIL) CITOZIN MONOHIDROKLORIDA NOVEL STABLE CRYSTAL OF 1-(2'-CYANO-2'-DEOXY-BETA -D-ARABINOFURANOSYL)CYTOSINE MONOHYDROCHLORIDE
<b>A61P 35/00</b> (2006.01)	P20131090	NOVI STABILNI KRISTALI 1-(2'-CIJANO-2'-DEOKSI-β-D-ARABINOFURANOZIL) CITOZIN MONOHIDROKLORIDA NOVEL STABLE CRYSTAL OF 1-(2'-CYANO-2'-DEOXY-BETA -D-ARABINOFURANOSYL)CYTOSINE MONOHYDROCHLORIDE
<b>B65D 85/804</b> (2006.01)	P20201294	SPREMNIK ZA PRIPREMU NAPITAKA PORTION CONTAINER FOR EXTRACTABLE SUBSTANCES FOR PRODUCING A BEVERAGE
<b>C07H 19/06</b> (2006.01)	P20131090	NOVI STABILNI KRISTALI 1-(2'-CIJANO-2'-DEOKSI-β-D-ARABINOFURANOZIL) CITOZIN MONOHIDROKLORIDA NOVEL STABLE CRYSTAL OF 1-(2'-CYANO-2'-DEOXY-BETA -D-ARABINOFURANOSYL)CYTOSINE MONOHYDROCHLORIDE

# Kazalo nositelja izmijenjenih prijevoda europskih патената

Nositelj патента (73)	MKP (51)	Broj патента (11)	Naziv izuma (54)
BBC Bremer Bagasse Company GmbH & Co. KG, MU	<b>B65D 85/804</b> (2006.01)	P20201294	SPREMNIK ZA PRIPREMU NAPITAKA
Delta-Fly Pharma, Inc., JP	<b>C07H 19/06</b> (2006.01) <b>A61K 31/7068</b> (2006.01) <b>A61P 35/00</b> (2006.01)	P20131090	NOVI STABILNI KRISTALI 1-(2'-CIJANO-2'-DEOKSI-β-D-ARABINOFURANOZIL) CITOZIN MONOHIDROKLORIDA

# Objava upisa promjena u registru патената

## Promjena imena/naziva nositelja europskih патената

Broj патената (11)	Raniji zapis	Novi zapis	Datum upisa promjene
P20160212	Ganymed Pharmaceuticals AG, An der Goldgrube 12, 55131 Mainz, DE	Ganymed Pharmaceuticals GmbH, An der Goldgrube 12, 55131 Mainz, DE	23.02.2024
P20201124	Xylo Technologies AG, Rütihofstrasse 1, 9052 Niederteufen, CH	Lignum Technologies AG, Rütihofstrasse 1, 9052 Niederteufen, CH	27.02.2024
P20210281	Xylo Technologies AG, Rütihofstrasse 1, 9052 Niederteufen, CH	Lignum Technologies AG, Rütihofstrasse 1, 9052 Niederteufen, CH	27.02.2024
P20210545	Xylo Technologies AG, Rütihofstrasse 1, 9052 Niederteufen, CH	Lignum Technologies AG, Rütihofstrasse 1, 9052 Niederteufen, CH	27.02.2024
P20210586	Xylo Technologies AG, Rütihofstrasse 1, 9052 Niederteufen, CH	Lignum Technologies AG, Rütihofstrasse 1, 9052 Niederteufen, CH	27.02.2024
P20210873	Xylo Technologies AG, Rütihofstrasse 1, 9052 Niederteufen, CH	Lignum Technologies AG, Rütihofstrasse 1, 9052 Niederteufen, CH	27.02.2024
P20220302	Xylo Technologies AG, Rütihofstrasse 1, 9052 Niederteufen, CH	Lignum Technologies AG, Rütihofstrasse 1, 9052 Niederteufen, CH	27.02.2024
P20220826	Xylo Technologies AG, Rütihofstrasse 1, 9052 Niederteufen, CH	Lignum Technologies AG, Rütihofstrasse 1, 9052 Niederteufen, CH	27.02.2024
P20220857	Xylo Technologies AG, Rütihofstrasse 1, 9052 Niederteufen, CH	Lignum Technologies AG, Rütihofstrasse 1, 9052 Niederteufen, CH	27.02.2024
P20220969	Xylo Technologies AG, Rütihofstrasse 1, 9052 Niederteufen, CH	Lignum Technologies AG, Rütihofstrasse 1, 9052 Niederteufen, CH	27.02.2024
P20221525	ARS Pharmaceuticals Inc., 11682 El Camino Real, Suite 120, San Diego, CA 92130, US	ARS Pharmaceuticals Operations, Inc., 11682 El Camino Real, Suite 120, San Diego, CA 92130, US	29.02.2024
P20230301	Xylo Technologies AG, Rütihofstrasse 1, 9052 Niederteufen, CH	Lignum Technologies AG, Rütihofstrasse 1, 9052 Niederteufen, CH	27.02.2024
P20230578	Xylo Technologies AG, Rütihofstrasse 1, 9052 Niederteufen, CH	Lignum Technologies AG, Rütihofstrasse 1, 9052 Niederteufen, CH	27.02.2024
P20230579	Xylo Technologies AG, Rütihofstrasse 1, 9052 Niederteufen, CH	Lignum Technologies AG, Rütihofstrasse 1, 9052 Niederteufen, CH	27.02.2024
P20230580	Xylo Technologies AG, Rütihofstrasse 1, 9052 Niederteufen, CH	Lignum Technologies AG, Rütihofstrasse 1, 9052 Niederteufen, CH	27.02.2024
P20230581	Xylo Technologies AG, Rütihofstrasse 1, 9052 Niederteufen, CH	Lignum Technologies AG, Rütihofstrasse 1, 9052 Niederteufen, CH	27.02.2024
P20230995	Xylo Technologies AG, Rütihofstrasse 1, 9052 Niederteufen, CH	Lignum Technologies AG, Rütihofstrasse 1, 9052 Niederteufen, CH	27.02.2024
P20231095	Xylo Technologies AG, Rütihofstrasse 1, 9052 Niederteufen, CH	Lignum Technologies AG, Rütihofstrasse 1, 9052 Niederteufen, CH	27.02.2024

## Prijenos prava

Broj патената (11)	Raniji zapis	Novi zapis	Datum upisa promjene
P20131165	Euromed SA, Pol. Can Margarola C/Rec de Dalt, 21-23, 08100 Mollet del Valles, ES	Madaus GmbH, Colonia Allee 15, 51067 Köln, DE	22.02.2024
P20160212	Ganymed Pharmaceuticals GmbH, An der Goldgrube 12, 55131 Mainz, DE	Astellas Pharma Inc., 5-1, Nihonbashi-Honcho 2-Chome Chuo-ku, 103-8411 Tokyo, JP	23.02.2024
P20160212	Johannes-Gutenberg-Universität Mainz, Saarstrasse 21, 55122 Mainz, DE	TRON - Translationale Onkologie an der Universitätsmedizin der Johannes Gutenberg-Universität Mainz gemeinnützige GmbH, Freiligrathstrasse 12, 55131 Mainz, DE	29.02.2024
P20161148	Sykehuset Sorlandet HF, Postboks 416, 4604 Kristiansand, NO	Christian Kersten, Maudsvei 98, 4633 Kristiansand S, NO	23.02.2024
P20161148	Sykehuset Sorlandet HF, Postboks 416, 4604 Kristiansand, NO	Marte Gronlie Cameron, Major Laudalsvei 33, 4633 Kristiansand S, NO	23.02.2024

Broj patenta (11)	Raniji zapis	Novi zapis	Datum upisa promjene
P20161148	Sykehuset Sorlandet HF, Postboks 416, 4604 Kristiansand, NO	Svein Mjaland, Skippergata 104, 4633 Kristiansand S, NO	23.02.2024
P20171055	Saint-Denis S.A., avenue Isidore Gérard, 1160 Auderghem, BE	Frank Mestdagh, Rue Griant 1, 5537 Bioul, BE	29.02.2024
P20171055	Xylowatt S.A., 30 rue Thomas Bonehill, 6030 Charleroi, BE	Saint-Denis S.A., avenue Isidore Gérard, 1160 Auderghem, BE	29.02.2024
P20171057	Saint-Denis S.A., avenue Isidore Gérard, 1160 Auderghem, BE	Frank Mestdagh, Rue Griant 1, 5537 Bioul, BE	29.02.2024
P20171057	Xylowatt S.A., 30 rue Thomas Bonehill, 6030 Charleroi, BE	Saint-Denis S.A., avenue Isidore Gérard, 1160 Auderghem, BE	29.02.2024
P20190014	Ganymed Pharmaceuticals GmbH, An der Goldgrube 12, 55131 Mainz, DE	Astellas Pharma Inc., 5-1, Nihonbashi-Honcho 2-Chome Chuo-ku, 103-8411 Tokyo, JP	23.02.2024
P20190396	ISAGRO S.p.A., Via Caldera 21, 20153 Milano, IT	GOWAN CROP PROTECTION LIMITED, Rothamsted Research, West Common Harpenden, AL5 2JQ Hertfordshire, GB	05.03.2024
P20192267	Teijin Pharma Limited, 2-1, Kasumigaseki 3-chome, Chiyoda-ku, 100-0013 Tokyo, JP	TEIJIN LIMITED, 2-4, Nakanoshima 3-chome, Kita-ku, Osaka-shi, 530-0005 Osaka, JP	05.03.2024
P20210047	KemPharm, Inc., 1180 Celebration Blvd., Suite 103, Celebration, FL 34747, US	KemPharm Denmark A/S, Ole Maaløes Vej 3, 2200 Copenhagen N, DK	27.02.2024
P20210285	Teijin Pharma Limited, 2-1, Kasumigaseki 3-chome, Chiyoda-ku, 100-0013 Tokyo, JP	TEIJIN LIMITED, 2-4, Nakanoshima 3-chome, Kita-ku, Osaka-shi, 530-0005 Osaka, JP	05.03.2024
P20211360	Teijin Pharma Limited, 2-1, Kasumigaseki 3-chome, Chiyoda-ku, 100-0013 Tokyo, JP	TEIJIN LIMITED, 2-4, Nakanoshima 3-chome, Kita-ku, Osaka-shi, 530-0005 Osaka, JP	05.03.2024
P20220968	Filip Rázga, Sokolská 15, 90301 Senec, SK	Selecta Biotech SE, Istrijská 6094/20, 84107 Bratislava - mestská časť Devínska Nová Ves, SK	05.03.2024
P20220968	Veronika Némethová, Vajanského 7, 94001 Nové Zámky, SK	Selecta Biotech SE, Istrijská 6094/20, 84107 Bratislava - mestská časť Devínska Nová Ves, SK	05.03.2024
P20230710	Deltacore GmbH, Volksgartenstraße 14, 4600 Wels, AT	BBCompetentia GmbH, Haid 26, 4782 St. Florian am Inn, AT	27.02.2024

# Objava prestanaka vrijednosti europskih patenata

Broj patenta	MKP	Datum prestanka vrijednosti patenta	Patent objavljen u HGIV-u br.	Naziv izuma
(11)	(51)			(54)
P20120120	<b>C23C 14/28</b> (2006.01) <b>C23C 14/50</b> (2006.01)	25.08.2023	5/2012	POSTUPAK ZA NANOŠENJE MATERIJALA
P20150800	<b>A61B 17/80</b> (2006.01) <b>A61B 17/86</b> (2006.01) <b>A61B 17/17</b> (2006.01)	12.08.2023	19/2015	VISOKO SVESTRANI SUSTAV PLOČICA ZA KOSTI S PROMJENJIVIM KUTOM
P20150801	<b>A61B 17/80</b> (2006.01) <b>A61B 17/86</b> (2006.01) <b>A61B 17/17</b> (2006.01)	12.08.2023	19/2015	VISOKO SVESTRANI SUSTAV PLOČICA ZA KOSTI S PROMJENJIVIM KUTOM
P20160552	<b>C07K 7/62</b> (2006.01) <b>A61K 38/12</b> (2006.01) <b>C12P 21/04</b> (2006.01) <b>A61P 31/04</b> (2006.01)	10.08.2023	15/2016	DERIVATI POLIMIKSINA I NJIHOVE UPORABE
P20161054	<b>A41B 11/00</b> (2006.01) <b>A41D 13/06</b> (2006.01) <b>A41B 11/02</b> (2006.01)	25.08.2023	23/2016	KRATKA ČARAPA
P20171748	<b>C07F 9/60</b> (2006.01) <b>C07F 9/6512</b> (2006.01) <b>A61K 31/4709</b> (2006.01) <b>C07D 401/12</b> (2006.01) <b>C07D 403/12</b> (2006.01) <b>C07D 401/14</b> (2006.01) <b>C07D 403/14</b> (2006.01)	26.08.2023	26/2017	6-AMINO KINAZOLINA ILI 3-CIJANO DERIVATI KINOLINA, POSTUPCI PRIPRAVE I NJIHOVA FARMACEUTSKA UPORABA
P20180669	<b>H04L 67/12</b> (2022.01) <b>H04L 69/18</b> (2022.01) <b>G07C 5/00</b> (2006.01) <b>G07C 5/08</b> (2006.01)	11.08.2023	12/2018	UNIVERZALNI SUSTAV ZA SNIMANJE DOGAĐAJA/PODATAKA
P20180790	<b>G01N 33/68</b> (2006.01) <b>C12Q 1/68</b> (2018.01)	12.08.2023	13/2018	NOVI POSTUPAK I KOMPLET ZA PREDVIĐANJE USPJEHA IN VITRO OPLODNJE
P20180834	<b>H04N 19/463</b> (2014.01) <b>H04N 19/176</b> (2014.01) <b>H04N 19/159</b> (2014.01) <b>H04N 19/44</b> (2014.01) <b>H04N 19/11</b> (2014.01) <b>H04N 19/593</b> (2014.01)	12.08.2023	14/2018	METODA ZA USPOSTAVLJANJE UNUTAROKVIRNOG PREDVIĐANJA
P20181098	<b>H04N 19/463</b> (2014.01) <b>H04N 19/176</b> (2014.01) <b>H04N 19/159</b> (2014.01) <b>H04N 19/44</b> (2014.01) <b>H04N 19/11</b> (2014.01) <b>H04N 19/593</b> (2014.01)	12.08.2023	18/2018	METODA ZA USPOSTAVLJANJE UNUTAROKVIRNOG PREDVIĐANJA
P20181145	<b>H04N 19/463</b> (2014.01) <b>H04N 19/176</b> (2014.01) <b>H04N 19/159</b> (2014.01) <b>H04N 19/44</b> (2014.01) <b>H04N 19/11</b> (2014.01) <b>H04N 19/593</b> (2014.01)	12.08.2023	19/2018	METODA ZA KODIRANJE UNUTAROKVIRNOG PREDVIĐANJA
P20181147	<b>H04N 19/463</b> (2014.01) <b>H04N 19/176</b> (2014.01) <b>H04N 19/159</b> (2014.01) <b>H04N 19/44</b> (2014.01) <b>H04N 19/11</b> (2014.01) <b>H04N 19/593</b> (2014.01)	12.08.2023	19/2018	METODA ZA KODIRANJE UNUTAROKVIRNOG PREDVIĐANJA
P20182105	<b>B27D 1/06</b> (2006.01) <b>B27M 3/04</b> (2006.01) <b>E04F 15/04</b> (2006.01) <b>B27M 3/00</b> (2006.01)	26.08.2023	3/2019	POSTUPAK ZA PROIZVODNJU LAMELARNE JEZGRE
P20190008	<b>C07K 16/18</b> (2006.01)	09.08.2023	7/2019	PREVENCIJA I LIJEČENJE SINUKLEINOPATSKE I AMILOIDOGENE BOLESTI
P20190178	<b>A61K 9/24</b> (2006.01) <b>A61K 31/155</b> (2006.01) <b>A61P 3/10</b> (2006.01)	24.08.2023	9/2019	FARMACEUTSKI SASTAV ZA LIJEČENJE DISGLIKEMIJE I IZLETA GLUKOZE



Broj patenta (11)	MKP (51)	Datum prestanka vrijednosti patenta	Patent objavljen u HGIV-u br.	Naziv izuma (54)
P20190872	<b>B41M 3/12</b> (2006.01) <b>B41M 5/025</b> (2006.01) <b>B41M 5/34</b> (2006.01) <b>B42D 25/36</b> (2014.01) <b>B42D 25/29</b> (2014.01) <b>B42D 25/455</b> (2014.01) <b>B42D 25/46</b> (2014.01) <b>B42D 25/328</b> (2014.01) <b>B42D 25/364</b> (2014.01) <b>B42D 25/378</b> (2014.01) <b>B44C 1/17</b> (2006.01) <b>B44F 1/08</b> (2006.01) <b>B44F 1/14</b> (2006.01) <b>B41M 3/14</b> (2006.01)	11.08.2023	14/2019	TRANSFERNA FOLIJA I POSTUPAK ZA PROIZVODNJU TRANSFERNE FOLIJE
P20191031	<b>C07D 241/08</b> (2006.01) <b>C07D 487/04</b> (2006.01) <b>C07D 495/04</b> (2006.01) <b>A61K 31/4985</b> (2006.01) <b>A61P 11/00</b> (2006.01)	27.08.2023	17/2019	SPOJEVI IN DANIL UREE KOJI INHIBIRAJU P38 MAP KINAZU
P20191547	<b>B29B 7/74</b> (2006.01) <b>A23P 30/40</b> (2016.01) <b>A23G 3/14</b> (2006.01) <b>B29C 44/60</b> (2006.01) <b>A23G 3/52</b> (2006.01) <b>B29B 7/72</b> (2006.01)	28.08.2023	24/2019	POSTUPAK I UREĐAJ ZA KONTROLU PROCESA POSTROJENJA ZA KONTINUIRANU PROIZVODNJU PJENA
P20200272	<b>C07K 16/30</b> (2006.01) <b>C07K 16/28</b> (2006.01) <b>C07K 16/40</b> (2006.01) <b>A61P 35/00</b> (2006.01) <b>C07K 14/55</b> (2006.01) <b>A61K 47/50</b> (2017.01)	25.08.2023	11/2020	KOMBINIRANA TERAPIJA ZA IMUNOCITOKINE VARIJANTE IL-2 USMJERENE NA TUMOR I PROTUTIJELA PROTIV HUMANOG PD-L1
P20200461	<b>B25D 11/12</b> (2006.01) <b>A01B 1/02</b> (2006.01) <b>B25F 5/02</b> (2006.01)	24.08.2023	13/2020	ELEKTRIČNI ČEKIĆ
P20200502	<b>E01F 13/12</b> (2006.01)	25.08.2023	13/2020	POMIČNA MODULARNA PREPREKA ZA VOZILA
P20201972	<b>C07D 231/12</b> (2006.01) <b>C07D 401/04</b> (2006.01) <b>A01P 7/00</b> (2006.01) <b>A01N 43/48</b> (2006.01)	11.08.2023	3/2021	DERIVATI PIROLA, DIAZOLA, TRIAZOLA ILI TETRAZOLA ZA BORBU PROTIV ARTROPODA
P20210579	<b>C07K 16/00</b> (2006.01) <b>C07K 16/30</b> (2006.01) <b>C12N 5/00</b> (2006.01)	09.08.2023	11/2021	CISTEINI PROTUTIJELA S KAPOM I BEZ KAPE, TE NJIHOVA UPOTREBA U KONJUGIRANJU PROTUTIJELA S LIJEKOM
P20211089	<b>E04F 11/18</b> (2006.01)	28.08.2023	26/2021	NOSIVI PROFIL S ELEMENTOM ZA PODEŠAVANJE
P20211217	<b>E04F 15/02</b> (2006.01) <b>E04F 15/04</b> (2006.01)	10.08.2023	22/2021	PODNA PLOČA ZA OBLIKOVANJE PODNE OBLOGE
P20211607	<b>A01M 21/04</b> (2006.01)	28.08.2023	3/2022	UREĐAJ I POSTUPAK ZA SUZBIJANJE KOROVA PRIMJENOM VISOKOTEMPERATURNE TEKUĆINE
P20230738	<b>A61K 38/02</b> (2006.01) <b>A61K 38/10</b> (2006.01) <b>A61K 38/16</b> (2006.01) <b>A61K 9/00</b> (2006.01) <b>A61K 9/16</b> (2006.01) <b>A61K 9/50</b> (2006.01) <b>A61K 47/32</b> (2006.01) <b>A61K 47/36</b> (2006.01) <b>A61P 25/00</b> (2006.01) <b>A61P 25/28</b> (2006.01)	09.08.2023	22/2023	DEPO SUSTAVI KOJI SADRŽE GLATIRAMER ACETAT

# Objava ispravaka podataka iz objavljenih europskih патената

Identifikator dokumenta (10)	MKP (51)	Podatak objavljen u HGIV-u br.	Ispravljeni podatak
HR P20231327 T8	<b>F24S 25/11</b> (2018.01) <b>H02S 20/00</b> (2014.01)	4/2024	Vidi INID (31), (32) i (33)

# Objava podataka iz zahtjeva za izdavanje svjedodžbe

---

- (21) [S20240003A](#) (22) 27.02.2024.  
(43) 15.03.2024.
- (68) [P20231581T](#)
- (54) PRIPRAVCI I POSTUPCI ZA KIMERNE KONSTRUKTE VIRUSA  
DENGA GROZNICE U CJEPIVIMA
- (93) EU/1/22/1699, 06.12.2022.,
- (95) **ČETVEROVALENTNO CJEPIVO PROTIV DENGE (ŽIVO,  
ATENUIRANO)**
- (71) Takeda Vaccines, Inc., 75 Sidney Street, Cambridge, MA 02139,  
US  
The Government of The United States of America as represented  
by The Secretary of The Department of Health and Human  
Services, 4770 Buford Highway, Technology Transfer Office (K79),  
Atlanta, GA 30341, US
- (74) PRODUCTA d.o.o., Zagreb, HR
- 

- (21) [S20240005A](#) (22) 04.03.2024.  
(43) 15.03.2024.
- (68) [P20130656](#)
- (54) DERIVATI BENZONITRILA SUPSTITUIRANI  
GLUKOPIRANOZILOM, FARMACEUTSKI SASTAVI KOJI SADRŽE  
TAKVE SPOJEVE, NJIHOVA UPORABA I POSTUPAK NJIHOVE  
PROIZVODNJE
- (93) EU/2/23/305/001, 22.11.2023.,
- (95) **VELAGLIFLOZIN**
- (71) Boehringer Ingelheim International GmbH, Binger Strasse 173,  
55216 Ingelheim am Rhein, DE
- (74) CPZ - CENTAR ZA PATENTE d.o.o., Zagreb, HR
-

# Kazalo proizvoda za koje je podnesen zahtjev za izdavanje svjedodžbi

Broj zahtjeva za izdavanje svjedodžbe (21)	Naziv proizvoda (95)	Datum podnošenja zahtjeva (22)
S20240003A	ČETVEROVALENTNO CJEPIVO PROTIV DENGE (ŽIVO, ATENUIRANO)	27.02.2024.
S20240005A	VELAGLIFLOZIN	04.03.2024.

# Kazalo podnositelja zahtjeva za izdavanje svjedodžbi

Podnositelj zahtjeva za izdavanje svjedodžbe (71)	Broj zahtjeva za izdavanje svjedodžbe (21)	Datum podnošenja zahtjeva (22)
Boehringer Ingelheim International GmbH, DE	S20240005A	04.03.2024.
Takeda Vaccines, Inc., US	S20240003A	27.02.2024.
The Government of The United States of America as represented by The Secretary of The Department of Health and Human Services, US	S20240003A	27.02.2024.

# Objava proglašenja svjedodžbi ništavima

Broj svjedodžbe (11)	Datum donošenja odluke o proglašenju svjedodžbe ništavom	Svjedodžba objavljena u HGIV-u br.	Naziv proizvoda (95)
S20170007	22.02.2024	21/2022	ELUKSADOLIN ILI NJEGOVA FARMACEUTSKI PRIHVATLJIVA SOL

# Objava prestanaka vrijednosti svjedodžbi

Broj svjedodžbe (11)	Datum prestanka vrijednosti svjedodžbe	Svjedodžba objavljena u HGIV-u br.	Pravni temelj prestanka vrijednosti svjedodžbe
S20130053	01.03.2024	25/2017	Prestanak važenja Svjedodžbe (do 5 godina + 6 mj.)

# Objava uporabnih modela

---

- (51) MKP (10) [HR UM20230019 U2](#)  
**A62C 3/16** (2006.01)  
**A62C 35/13** (2006.01)
- (11) UM20230019A (45) 15.03.2024.  
(21) UM20230019 (22) 17.06.2022.
- (31) PV 2021-309 (32) 19.06.2021. (33) CZ
- (54) **AUTOMATSKI KOMUNIKACIJSKI SUSTAV ZA LOKALNO SUZBIJANJE PORASTA TEMPERATURE ILI GAŠENJE POŽARA U ELEKTRIČNOJ OPREMI SPOJENOJ NA IZVOR NAPAJANJA**  
AUTOMATIC COMMUNICATION SYSTEM FOR LOCAL SUPPRESSION OF RISING TEMPERATURE OR FIRE EXTINGUISHING IN ELECTRICAL EQUIPMENT CONNECTED TO A POWER SUPPLY
- (73) MEGELLAN, SE, Roháčova 1666/94, 13000 Prag 3-Žižkov, CZ  
(72) Marek Duda, Masarykova 596, 73581 Bohumín, Nový Bohumín, CZ  
Peter Rončák, Láň 2888, 75661 Rožnov pod Radhoštěm, CZ  
(74) Tatjana Sučić, Zagreb, HR
-



# Kazalo brojeva uporabnih modela

Broj uporabnog modela (11)	MKP (51)
UM20230019	<b>A62C 3/16</b> (2006.01) <b>A62C 35/13</b> (2006.01)

# Kazalo klasifikacijskih oznaka uporabnih modela prema Međunarodnoj klasifikaciji патената

MKP (51)	Broj uporabnog modela (11)	Naziv izuma (54)
<b>A62C 3/16</b> (2006.01)	UM20230019	AUTOMATSKI KOMUNIKACIJSKI SUSTAV ZA LOKALNO SUZBIJANJE PORASTA TEMPERATURE ILI GAŠENJE POŽARA U ELEKTRIČNOJ OPREMI SPOJENOJ NA IZVOR NAPAJANJA AUTOMATIC COMMUNICATION SYSTEM FOR LOCAL SUPPRESSION OF RISING TEMPERATURE OR FIRE EXTINGUISHING IN ELECTRICAL EQUIPMENT CONNECTED TO A POWER SUPPLY
<b>A62C 35/13</b> (2006.01)	UM20230019	AUTOMATSKI KOMUNIKACIJSKI SUSTAV ZA LOKALNO SUZBIJANJE PORASTA TEMPERATURE ILI GAŠENJE POŽARA U ELEKTRIČNOJ OPREMI SPOJENOJ NA IZVOR NAPAJANJA AUTOMATIC COMMUNICATION SYSTEM FOR LOCAL SUPPRESSION OF RISING TEMPERATURE OR FIRE EXTINGUISHING IN ELECTRICAL EQUIPMENT CONNECTED TO A POWER SUPPLY

# Kazalo nositelja uporabnih modela

Nositelj uporabnog modela (73)	MKP (51)	Broj uporabnog modela (11)	Naziv izuma (54)
MEGELLAN, SE, CZ	<b>A62C 3/16</b> (2006.01) <b>A62C 35/13</b> (2006.01)	UM20230019	AUTOMATSKI KOMUNIKACIJSKI SUSTAV ZA LOKALNO SUZBIJANJE PORASTA TEMPERATURE ILI GAŠENJE POŽARA U ELEKTRIČNOJ OPREMI SPOJENOJ NA IZVOR NAPAJANJA

# Objava prijava žigova

## RAZRED 2

(210) Z20231210A (220) 13.12.2023.  
(442) 15.03.2024.

(731) **AUTO HRVATSKA dioničko društvo**  
Ulica Vjekoslava Heinzela 70, 10000 Zagreb, HR

(540)

**AUTO HRVATSKA**  
**MOBILITY**

(591) antracit, plava, bijela  
(531) 27.05.01; 27.05.09; 29.01.04; 29.01.08

(511) **2** automobilske boje; boja za uporabu u proizvodnji automobila; boje i sredstva za pranje; boje na bazi vode [osim za izolaciju] za automobilsku industriju; boje za dodatno premazivanje vozila; boje za korištenje u automobilskoj industriji; boje za naplatke kotača; boje za strojeve; međupremazi za šasije vozila [boje i ulja]; premazi kao boje za automobilsku industriju; premazi kao boje za vozila; automobilski lakovi; lakovi za popravak motornih vozila; pripravci za sprečavanje hrđanja vozila; pripravci za sprečavanje hrđe u obliku premaza za vozila

**4** aditivi (nekemijski) za motorno gorivo; aditivi (nekemijski) za maziva; aditivi (nekemijski) za ulja; automobilska goriva; benzin [gorivo]; benzinsko gorivo; biodizelsko gorivo; dizel gorivo; fina ulja za motore; goriva dobivena iz nafte; goriva iz sirove nafte; goriva (uključujući benzin za motore); gorivo za motorna vozila; industrijska maziva; industrijska rashladna ulja; industrijska ulja i masti [maziva]; industrijska ulja za podmazivanje površina; kruta maziva; kruta maziva za industrijske potrebe; lubrikanti i industrijska maziva; lubrikanti kao hidraulična ulja za podmazivanje; lubrikanti u obliku ulja; masti za automobile; masti za kuglične ležajeve; masti za podmazivanje izloženih zupčanika; maziva za automobilske motore; mazivo za kočne pločice; mineralna ulja za podmazivanje; motorna ulja; nekemijski aditivi za motorna goriva; nekemijski koncentri aditiva za motorna goriva; nekemijski aditivi za ulja; nekemijski aditivi za ulja za mjenjače; nekemijski koncentri aditiva za maziva; posebno fina ulja za motore; pospješivači gorenja [ulja]; sintetička ulja; sintetička ulja za kompresore; sredstva za podmazivanje na osnovi ulja; sredstva za podmazivanje u obliku zupčaničkih ulja; ulja za automobile; ulja za diferencijal; ulja za motore automobila; ulja za podmazivanje; ulja za podmazivanje [industrijska sredstva za podmazivanje]; ulja za podmazivanje automobilskih uređaja; ulja za podmazivanje motora na benzin; ulja za podmazivanje za kotače; ulja za turbine; ulja za turbo jedinice; ulja za zupčanike; vodonepropusni pripravci u obliku ulja za sustave paljenja motornih vozila; voskovi i tekućine; ulje za motore; ulje za podmazivanje za motore motornih vozila

**7** alati [dijelovi strojeva]; alatni strojevi; bušilice za alatne strojeve; cilindri za motore strojeva za kopnena vozila; disk kočnice kao dijelovi strojeva; dizalice za vozila [strojevi]; filtri [dijelovi strojeva i motora]; filtri za ulje [dijelovi strojeva i motora]; francuski ključevi [strojevi]; klipovi [dijelovi strojeva ili motora]; strojevi za vulkanizaciju guma; zračni jastuci (motori vozila sa zračnim jastukom); zupčanici strojeva; zupčanici za strojeve; zupčanični mehanizmi strojeva; zupčaste jedinice za strojeve; zupčaste spojke za strojeve

**8** abrazivni brusni kotači [ručno pokretani alati]; abrazivni diskovi [dijelovi ručnih alata]; alat [neelektrični alat]; čekići; dizalice [ručne dizalice]; francuski ključevi; francuski ključevi [ručno pokretani alat]; francuski ključevi za matice; ključevi [alat]; ključevi za svjećice; kolica dizalice za vozila [ručno pokretana]; nasadni

ključevi [ručni alat]; nasadni ključevi [ručno pokretani alat]; podesivi ključevi [alat]; podesivi ključevi [ručni alat]; poluge za postavljanje guma; ručne bušilice; ručne dizalice; ručne dizalice [ručni alat]; ručni alat [ručno pokretani]; ručno pokretane dizalice; ručno pokretani alati; svrdla [alat]; svrdla [dijelovi ručnog alata]; svrdla [ručni alat]; svrdla za ručne bušilice; torbe za alat [pune]; viljuškasti ključevi; zračne pumpe, ručne acetometri za akumulator; akumulatori (električni akumulatori za vozila); akumulatori za automobile; akumulatori za vozila; akumulatorski kablovi; alkalni akumulatori; automatski dojavljivači gubitka tlaka u zračnicama; električni akumulatori; električni akumulatori za vozila; indikatori razine ulja u vozilima; kablovi za punjače akumulatora; kleme za akumulator; kućišta akumulatora; manometri za automobilske gume; mjerači dubine profila automobilske gume; mjerači za gume; nikal-kadmijevi akumulatori; ploče za akumulator; pokretači [starteri] akumulatora; prekidači za deaktivaciju automobilskih zračnih jastuka; rešetke za električne akumulator; senzori istrošenosti kočioni pločica; senzori razine ulja; tester ulja u kočnicama; uređaji i instrumenti za akumuliranje električne energije; uređaji za punjenje akumulatorskih baterija motornih vozila; uređaji za punjenje električnih akumulatora; uređaji za testiranje baterija [akumulatora]

**12** automobilske gume; automobilske gume (pneumati); cijevi zračnih kočnica za kamione; čeljusti kočnica kopnenih vozila; čeljusti za kočnice vozila; disk kočnice; disk kočnice za kopnena vozila; diskovi kočnica za vozila; dizelski turbinski motori za kopnena vozila; gume (pneumati); gume [za automobile]; gume i gusjenice; gume kotača vozila; gume za kopnena vozila; gume za kotače motornih vozila; gume za kotače vozila; gume za vozila; gumene zakrpe za popravak zračnica kotača vozila; gumene zakrpe za popravak zračnica kotača vozila; gumene zakrpe za popravak pneumatika za vozila; gumeni kotači [vanjski omotači gumenih kotača]; hidraulične disk kočnice; hidraulične turbine za kopnena vozila; kočioni sustavi za vozila i njihovi dijelovi; kočne pločice vozila; kočne pločice za automobile; kočne pločice za vozila; kotači; kotači (vanjske gume za kotače vozila); lanci za gume protiv proklizavanja; ljepljive gumene zakrpe za popravak zračnica ili guma; materijali za krpanje zračnica pneumatika; materijali za zakrpe; obloge disk kočnica za kočne sustave vozila; obloge disk kočnica za kopnena vozila; obloge disk kočnica za vozila; parne turbine za kopnena vozila; plinske turbine za kopnena vozila; pločice kočnice za kopnena vozila; pneumatske gume; poklopci ventila za gume vozila; protektirane gume; rotor disk kočnica za kočne sustave vozila; turbine sa sabijenim zrakom za kopnena vozila; turbine za kopnena vozila; turbinske lopatice kao dijelovi motora kopnenih vozila; turbinske osovine [dijelovi kopnenih vozila]; unutarnje gume [zračnice] za kotače vozila; unutarnje gume [zračnice] za kotače vozila; vanjske gume od pune gume za kotače vozila; vanjske gume vozila; vanjske gume za kotače vozila; ventili za gume; ventili za gume vozila; vozila [gumeni kotači vozila]; zakrpe za gume; zakrpe za unutarnje zračnice guma; zračne turbine za kopnena vozila; zračni jastuci na napuhavanje za vozila radi sprječavanja ozljeda uslijed nesreća; zračni jastuci za vozila; zračnice; zračnice (ljepljive gumene zakrpe za krpanje zračnica); zračnice (ljepljive gumene zakrpe za popravak); zračnice [za automobilske gume]; zračnice guma; zračnice za gume; zračnice za gume vozila; zračnice za kotače; zračnice za pneumatske gume; zračnice za pneumatske gume vozila

**17** artikli od gume za sprječavanje ispuhavanja guma vozila; boje na bazi vode [izolirajuće] za uporabu u automobilskoj industriji; brtve (nemetalne -) za automobilske aplikacije; brtve za automobilsku uporabu; brtve za kamione; brtve za komercijalna

vozila; brtvene trake za uporabu u automobilima; brtvila za spojeve u karoseriji vozila; cijevi (nemetalne-) za radijatore vozila; cijevi (nemetalne spojne-) za radijatore vozila; cijevi za priključak grijača vozila; folije za vozila za zaštitu od UV zraka; gumene cijevi za motorna vozila; hidraulična crijeva [nemetalna, osim dijelova hidrauličkog sustava vozila]; hladnjake vozila (priključna cijev za-); kalup za ubrizgavanje za dijelove motora automobila; plastične cijevi za motorna vozila; poluobrađeni listovi za kočničke obloge vozila; predizolirane savitljive spojne cijevi (nemetalne) za uporabu u motornim vozilima; reflektivne plastične folije za uporabu na prozorima vozila; smjesa za brtvljenje spojeva na vozilima; spojna crijeva za ubrizgavače goriva za vozila; spojne cijevi za radijatore vozila; uljna brtvila za vozila; unaprijed izolirane savitljive spojne cijevi (nemetalne -) za uporabu u motorima vozila; vinilna folija za karoserije vozila; zatamnjene plastične folije za uporabu na prozorima vozila

- 36 administracija financijskih poslova; administracija financijskih poslova u svezi s nekretninama; administracija financijskih sporazuma; administracija grupnog osiguranja; administracija investicija; administracija nekretnina; administracija osiguranja; administracija planova beneficija za zaposlenike; administracija planova osiguravanja; administracija planova socijalnog osiguranja za zaposlenike; administracija planova za grupno osiguranje; administracija potraživanja od osiguranja; analiza financijskih investicija i istraživanja u svezi s dionicama; analiza ulaganja; bilježenje prijenosa dionica; bilježenje prijenosa udjela; davanje uzaloga; davanje zemljišta u zakup; dogovaranje hipoteka i zajmova; financijska ocjena kreditne sposobnosti poduzeća; financijska ulaganja; financijske procjene; financijske procjene [nekretnina]; financijske usluge povezane s održavanjem vozila; financijske usluge povezane s prijevozom robe; financijske usluge povezane s kupnjom i trgovinom robe; financijske usluge u svezi s nekretninama i zgradama; financijske usluge u svezi s hipotekama; financijske usluge u svezi s motornim vozilima; financijske usluge u svezi s osiguranjem motornih vozila; financijske usluge u svezi s imovinom; financijske usluge u svezi sa stjecanjem imovine; financijske usluge u svezi s trgovinom motornim vozilima; financijske usluge u svezi s dionicama; financijske usluge u svezi s poslovnim djelatnostima; financijske usluge za kupnju nekretnina; financijske usluge za kupnju vozila; financijske usluge za pozajmljivanje novca; financijsko planiranje; financijsko sponzoriranje sportskih djelatnosti; financijsko upravljanje dionicama; financijsko vrednovanje osobne imovine i nekretnina; hipotekarni zajmovi i usluge financiranja; iznajmljivanje imovine; iznajmljivanje imovine i iznajmljivanje trajnog smještaja; iznajmljivanje komercijalnih prostora; iznajmljivanje nekretnina; iznajmljivanje ureda; iznajmljivanje uredskog prostora; iznajmljivanje zgrada; konzultantske usluge i usluge posredovanja u vezi s osiguranjem vozila; konzultantske usluge povezane s financijama; konzultantske usluge povezane s investicijama; konzultantske usluge u svezi s financijama poduzeća; konzultantske usluge u svezi s nekretninama; korporativno financiranje; korporativno pozajmljivanje; nekretnine (zakup -); posredovanje osiguranja motornih vozila; procjena i upravljanje nekretninama; procjena i vrednovanje nekretnina; procjena nekretnina [financijska]; procjena nekretnine; procjena rabljenih automobila; pružanje financija za kupnju motornih vozila; pružanje financija za kupnju vozila; pružanje financijskih informacija u svezi s dionicama; pružanje informacija o procjeni rabljenih automobila; pružanje jamstava za rabljena terenska vozila; pružanje jamstava za terenska vozila; pružanje jamstava za vozila; pružanje osiguranih zajmova; pružanje podataka u svezi s imovinom [nekretnine]; pružanje podataka u svezi s nekretninama; pružanje podataka u svezi s tržišnom imovinom [nekretnine]; pružanje zajmova; pružanje zajmova i kreditnih pogodnosti; pružanje zajmova u obrocima; rješavanje potraživanja od osiguranja; rješavanje zahtjeva za reosiguranjem; ugovaranje zajmova; ugovaranje zajmova otplativih u obrocima; ugovaranje zakupa i sporazuma o iznajmljivanju nekretnina; ugovaranje zakupa nekretnine; ugovaranje zakupa za iznajmljivanje trgovačkog vlasništva; ugovaranje zakupa za iznajmljivanje imovine; upravljanje imovinom i portfeljem; upravljanje imovinom [nekretninama]; usluge financiranja za kupnju automobila; usluge

pozajmljivanja novca; usluge upravljanja nekretninama; usluge upravljanja nekretninama u vezi s uredskim prostorijama; usluge upravljanja nekretninama u vezi s poslovnim zgradama; vrednovanja i financijske procjene imovine; vrednovanja nekretnina; vrednovanje imovine; zajam na temelju zaloga; zakup i iznajmljivanje poslovnih prostora; zakup ili iznajmljivanje zgrada; zakup nekretnina; zakup nekretnine; zakup stanova; zakup trgovačkih prostora; zakup zemljišta; zakup zgrada; zakupi (ugovaranje -) [samo nekretnine]; založne usluge za nekretnine

39 cestovna dostava pošiljaka; distribucija [prijevoz] maloprodajne robe; distribucija [prijevoz] robe cestovnim putem; dostava cestom; dostavljačke usluge [roba]; dostavljačke usluge za dostavu robe; dostavljačke usluge za prijevoz tereta; iznajmljivanje autobusa; iznajmljivanje automobila; iznajmljivanje cestovnih vozila; iznajmljivanje garaža i parkirnih mjesta; iznajmljivanje garaže; iznajmljivanje garažnih parkirnih mjesta; iznajmljivanje garažnog prostora; iznajmljivanje kamiona; iznajmljivanje kamiona i vozila; iznajmljivanje kamiona i prikolica; iznajmljivanje komercijalnih vozila; iznajmljivanje kopnenih motornih vozila; iznajmljivanje mjesta za parkiranje; iznajmljivanje motornih cestovnih vozila; iznajmljivanje motornih vozila; iznajmljivanje parkirališta za vozila; iznajmljivanje parkirališta; iznajmljivanje parkirališnih mjesta; iznajmljivanje parkirnih mjesta; iznajmljivanje parkirnih mjesta i garaža za vozila; iznajmljivanje prijevoznih sredstava; iznajmljivanje prostora za parkiranje automobila; iznajmljivanje prostora za skladištenje; iznajmljivanje putničkih vozila; iznajmljivanje skladišnog prostora; iznajmljivanje skladišta; iznajmljivanje teretnih vozila; iznajmljivanje vozila; iznajmljivanje vozila, konkretno, automobila i kamiona; kamionski prijevoz; prijevoz tereta; prijevoz tereta cestovnim putem; prijevoz tereta kopnenim putem; prijevoz tereta kopnenim vozilima; pružanje podataka o automobilima za zakup putem interneta; skladištenje dijelova motornih vozila; skladištenje dijelova vozila; ugovorno iznajmljivanje motornih vozila; ugovorno iznajmljivanje transportnih vozila; ugovorno iznajmljivanje vozila; usluge dostave; usluge iznajmljivanja automobila; usluge iznajmljivanja motornih kopnenih vozila; usluge iznajmljivanja motornih vozila; usluge pomoći na cesti za motorna vozila; usluge pomoći na cesti za vozila; usluge pomoći na cesti za pokvarena vozila

## RAZRED 4

(210) Z20240012A (220) 08.01.2024.  
(442) 15.03.2024.  
(731) JAVNA USTANOVA "PARK PRIRODE LONJSKO POLJE"  
Krapje 16, 44324 Jasenovac, HR  
(540)



- (591) zelena, crna, bijela  
(531) 03.07.07; 03.07.24; 27.05.01; 27.05.10; 29.01.03; 29.01.08  
(511) 4 pčelinji vosak; pčelinji vosak za proizvodnju kozmetičkih proizvoda; svijeće (mirisne svijeće); svijeće\*; svijeće (dušice); svijeće (voštance) za božićna drvca; vosak (sirovina)  
5 matična mliječ kao dijetni dodatak prehrani; matična mliječ za farmaceutsku uporabu; metvica za farmaceutske potrebe; pelud kao dijetni dodatak prehrani  
14 artikli i pribor za nakit; broš igle (nakit); broševi (nakit); nakit (optočeni nakit); raspela kao nakit  
16 papir\*; vrećice, papirmate  
20 figurice od drva, voska, gipsa ili plastike; košaračka roba; košare za prijenos predmeta; košare, nemetalne; raspela od drva, voska, sadre ili plastike koja nisu nakit; vosak, sačasti za košnice  
21 daščice za kruh  
22 mreže\*; mreže za ribolov

- 24 platno\*; tkanina  
 25 nošnje  
 26 broševi (odjevni pribor)  
 28 figurice za igru; igračke\*; mreže (sportski pribor); vrše (ribarske naprave)  
 29 ajvar; aranžmani od prerađenog voća; džemovi; fermenti (mliječni fermenti) za upotrebu u kulinarstvu; jaja\*; jela na bazi ribe; kobasice (salame); kobasice od svinjetine, masti, kruha, zobene kaše i začina; kompot od jabuka; kompoti; krastavci, ukiseljeni; krvavice (suhomesnati proizvodi); kukuruz šećerac, prerađeni; loj za prehranu; lješnjaci, pripremljeni; maslac; meso; meso sušeno u smrznutom stanju; meso, konzervirano; meso, svinjsko meso; mliječni napici u kojima mlijeko prevladava; mliječni proizvodi; mlijeko; namazi koji sadrže mast, za kruh; namazi od baza orašastih plodova; namazi na bazi povrća; obrađeno povrće; obrađeno voće; orasi, pripremljeni; pekmezi; pelud pripremljena za prehranu; perad (meso od peradi); povrće sušeno u smrznutom stanju; rajčica (sok od rajčica) za kuhinju; riba, neživa; salate od povrća; salo; sirevi; slanina; sokovi, biljni za kuhanje; surutka od mlijeka; svježi sir; ulje za prehranu; voće konzervirano u alkoholu; voće, kuhano; voćna kaša; voćne grickalice; vrhnje (mliječni proizvod)  
 30 arome za hranu, osim eteričnih ulja; brašno orašastih plodova; brašno\*; čaj\*; čajevi, nemedicinski; čajni kolačići; kečap (umak od rajčice); kolači; kruh\*; krupica (griz); kukuruz, mljeveni; kukuruzna krupica; kukuruzne kokice (pucanci); kukuruzno brašno; matična mliječ\*; med; medenjaci; metvica (bomboni od metvice); metvica za slastice; mljeveni češnjak (začin); napici na bazi čaja; ocat; orašasti plodovi obloženi čokoladom; palačinke; proizvodi od tijesta; propolis (pčelinji proizvod)\*; pšenično brašno; rezanci; rezanci za juhe; tijesto; tijesto za kolače; umak od rajčice; voćni kolači; voćni slatkiši; zobeno brašno; zobene pahuljice; zob, tucana; zob, očišćena  
 31 aranžmani od svježeg voća; biljke; biljke, osušene za ukrašavanje; buče, svježe; cikla, svježja; glijive, svježe; grah, svježi; grožđe, svježe; kopriva; krastavci, svježi; krumpiri; kukuruz; luk, svježi; lješnjaci, svježi; orašasti plodovi, neobrađeni; paprika (biljka); paprika (začin); pelud (sirovina); povrće, svježe; pšenica; salata, zelena (svježja); voće, svježe; zob; žitarice u zrnju, neobrađene; žito  
 32 aperitivi bez alkohola; bezalkoholna pića; bezalkoholna pića koja sadrže voće; bezalkoholni napitci od suhog voća; grožđe (mošt od grožđa); jabučni sok (bezalkoholni); med (bezalkoholni napici od meda); pića (bezalkoholna) sastojci za pripremu pića), sirupi za napitke; sirutka (piće od sirutke); sok od rajčice (napitak); sokovi, biljni (napici); voćni napici bez alkohola; voćni sokovi  
 33 alkohol od metvice (liker); alkoholna pića (unaprijed pomiješana alkoholna pića, osim onih na bazi piva); alkoholna pića koja sadrže voće; alkoholna pića osim piva; alkoholne esencije; alkoholni ekstrakti; aperitivi\*; jabukovača; kruškovača; liker; liker (gorki); medovina (piće od vode i meda); pića, destilirana; rakija; vina; žestoka alkoholna pića  
 36 usluge iznajmljivanja smještaja (nekretnine)  
 39 iznajmljivanje brodova  
 41 kampovi za ljetovanje (usluga kampova za ljetovanje)(zabava); komponiranje glazbe; komponiranje pjesama; pisanje tekstova\*; usluge umjetnika zabavljača  
 43 gostioničari (usluge gostioničara); hotelske usluge; iznajmljivanje privremenog smještaja; kampiranje (stavljanje na raspolaganje tereta za kampiranje); kampovi za ljetovanje (usluge kampova za ljetovanje) (smještaj); usluge iznajmljivanja smještaja (hotelski, pansioniski); usluge kafića; usluge kuća za odmor; usluge motela; usluge pansiona; usluge prijma za privremeni smještaj (upravljanje dolascima i odlascima); usluge restorana

## RAZRED 5

(210)	Z20231042A	(220)	30.10.2023.
		(442)	15.03.2024.
(731)	<b>TEVA PHARMACEUTICALS EUROPE B.V.</b> Piet Heinkade 107, 1019 GM Amsterdam, NL		
(740)	ZMP IP d.o.o., Zagreb, HR		
(540)			

# RHINAZ

(511) 5 farmaceutski pripravci i tvari

(210)	Z20231157A	(220)	27.11.2023.
		(442)	15.03.2024.

(731) **Ljekarna Pablo**  
Pulac 4/A, 51000 Rijeka, HR

(540)



(591) narančasta, zelena, plava, siva  
 (531) 24.13.01; 27.05.01; 29.01.14

- (511) 5 farmaceutski pripravci; lijekovi za ljudske potrebe; sanitarni proizvodi za medicinske potrebe; djetetne tvari za medicinske potrebe; prehrambeni aditivi za medicinske svrhe; hrana za dojenčad; vitaminski pripravci; medicinske pregrade; dezinficijensi; insekticidi i sredstva protiv insekata; kutije za prvu pomoć; higijenski preparati za upotrebu u medicini; djetetni dodaci prehrani; flasteri; materijal za previjanje; dodaci prehrani namijenjeni normalnoj prehrani ili za zdravstvene svrhe; medicinski šamponi, sapuni, losioni te preparati za njegu zuba  
 10 ortopedski proizvodi; pribor za šivanje rana; prezervativi; medicinski aparati i instrumenti; ortopedski proizvodi; pribor za šivanje rana; terapijski uređaji i pomagala prilagođeni osobama s invaliditetom; masažni uređaji; naprave, uređaji i proizvodi za dojenje  
 35 usluge maloprodaje farmaceutskih proizvoda, lijekova, medicinskih jednokratnih potrepština i medicinskih proizvoda za medicinsku upotrebu, također putem Interneta; logističke i administrativne usluge u pogledu upravljanja zalihama; poslovno planiranje i savjeti u vezi s upravljanjem zalihama; analiza troškova; poslovno planiranje i savjeti u vezi s kontrolom troškova  
 39 pakiranje i skladištenje robe; planiranje i savjetovanje vezano za skladištenje farmaceutskih proizvoda, lijekova, medicinskih jednokratnih predmeta i medicinskih proizvoda za medicinsku upotrebu  
 41 obrazovanje; treninzi  
 44 savjetovanje u području farmaceutskih pripravaka, lijekova, medicinskih jednokratnih potrepština i medicinskih proizvoda za medicinsku upotrebu; farmaceutske usluge (donošenje recepata)

(210)	Z20240066A	(220)	24.01.2024.
		(442)	15.03.2024.

(731) **Corteva Agriscience LLC**  
9330 Zionsville Road, Indianapolis, IN 46268, US  
 (740) CPZ - CENTAR ZA PATENTE d.o.o., Zagreb, HR  
 (540)

# VOLONTERRE

(511) 5 poljoprivredni herbicidi

## RAZRED 9

(210)	Z20230978A	(220)	11.10.2023.
		(442)	15.03.2024.

(731) **SOLAR LEKTUS d.o.o.**  
Risje 1, Gornji Desinec, 10450 Jastrebarsko, HR  
 (540)



(591)	crna, bijela, crvena		
(531)	26.01.01; 26.01.03; 26.04.01; 27.05.01; 29.01.01; 29.01.06; 29.01.08		
(511)	<b>9</b> aparati i instrumenti za vođenje, distribuiranje, transformiranje, akumuliranje, podešavanje ili upravljanje distribucijom ili korištenjem električne struje		
	<b>11</b> uređaji i instalacije za klimatizaciju, grijanje i hlađenje; solarni kolektori; kućni kamini		
	<b>37</b> vodoinstalaterske usluge; postavljanje centralnog grijanja; usluge postavljanja i popravaka toplinskih pumpi		

(210)	Z20230988A	(220)	13.10.2023.
		(442)	15.03.2024.
(731)	<b>QUANTUM BIT d.o.o.</b>		
(540)	Vrlička 29, 21000 Split, HR		

## AMOS

(511)	<b>9</b> aeronautički komunikacijski uređaji; aeronautički radio-komunikacijski strojevi i uređaji; automatski sustavi za otkrivanje dronova; sustavi za otkrivanje dronova		
-------	---	--	--

(210)	Z20231090A	(220)	14.11.2023.
		(442)	15.03.2024.
(731)	<b>ABC Informatic d.o.o.</b>		
(540)	Natka Nodila 17, 20000 Dubrovnik, HR		



(591)	plava, bijela, bež		
(531)	27.05.01; 27.05.05; 27.05.09; 27.05.10; 29.01.02; 29.01.04; 29.01.06		
(511)	<b>9</b> elektronički uređaji za identifikaciju i premjer plovila		
	<b>42</b> aplikacijska platforma (Saas) za upravljanje poslovnim procesima u turizmu		

(210)	Z20231162A	(220)	30.11.2023.
		(442)	15.03.2024.
(731)	<b>Hvaljen Budi d.o.o.</b>		
(540)	Bani 73, 10010 Zagreb, HR		



(591)	crvena		
(531)	27.05.01; 27.05.17; 27.05.05; 27.05.09; 27.05.10; 29.01.01		
(511)	<b>9</b> pretvarači napona; solarni moduli		

(210)	Z20231287A	(220)	29.12.2023.
		(442)	15.03.2024.
(731)	<b>NOVAMINA centar inovativnih tehnologija, d.o.o.</b>		
(540)	Zagrebačka cesta 145 A, 10000 Zagreb, HR		



(591)	plava, zelena, narančasta, bijela, siva		
(531)	01.03.01; 26.11.01; 26.11.13; 27.05.01; 27.05.10; 29.01.01; 29.01.03; 29.01.04		
(511)	<b>9</b> punjač za električne automobile		
	<b>37</b> iznajmljivanje prijenosnih punjača baterija za električne automobile		

(210)	Z20240004A	(220)	03.01.2024.
		(442)	15.03.2024.
(731)	<b>Enhance Production Limited</b>		
	Dept 3805a, 43 Owston Road, DN6 8DA Carcroft, Doncaster, GB		
(740)	ZMP IP d.o.o., Zagreb, HR		
(540)			

## COPILOT

(511)	<b>9</b> znanstveni, istraživački, navigacijski, nadzorni, fotografski, kinematografski, audiovizualni, optički aparati i instrumenti, aparati i instrumenti za vaganje, mjerenje, signalizaciju, detekciju, ispitivanje, inspekciju, spašavanje i poduku; aparati i instrumenti za provođenje, prebacivanje, transformaciju, akumulaciju, regulaciju ili kontrolu distribucije ili korištenja električne energije; aparati i instrumenti za snimanje, prijenos, reprodukciju ili obradu zvuka, prikaza ili podataka; snimljeni mediji i mediji koje je moguće preuzeti; računalni softver; računalni hardver; prazni digitalni ili analogni mediji za snimanje i pohranu; mehanizmi za aparate na kovanice; registarske blagajne; uređaji za računanje; računala i periferni uređaji prilagođeni za uporabu s računalima; odijela za ronjenje; ronilačke maske; ronilački tamponi za uši; štipaljke za nos za ronioce i plivače; rukavice za ronioce; uređaji za podvodno disanje; vatrogasni aparati		
	<b>14</b> plemeniti metali i njihove legure; nakit, drago i poludrago kamenje; urarski i kronometarski instrumenti		
	<b>42</b> znanstvene i tehnološke usluge kao i pripadajuće usluge istraživanja i koncepcije; usluge industrijskih analiza, industrijskih istraživanja i industrijskog dizajna; usluge kontrole kvalitete i utvrđivanja autentičnosti; softver kao usluga (saas); koncepcija i razvoj računala i računalnih programa.		

(210)	Z20240006A	(220)	05.01.2024.
		(442)	15.03.2024.
(731)	<b>Jobs d.o.o.</b>		
(540)	Zagrebačka cesta 86a, 10000 Zagreb, HR		

## Jobs

(511)	<b>9</b> elektroničke oglasne ploče		
-------	-------------------------------------	--	--

(210)	Z20240065A	(220)	24.01.2024.
		(442)	15.03.2024.
(731)	<b>Helb d.o.o.</b>		
(540)	Industrijska ulica 1, Božjakovina, 10370 Dugo Selo, HR		



(591)	tamnoplava		
(531)	26.04.01; 26.04.05; 26.04.18; 26.04.19; 27.05.23; 29.01.04; 29.01.11		

(511)	<b>9</b> analiza (uređaji za analizu)[ne za medicinske potrebe]; brojila; informatički programi [snimljeni]; mjerenje (električni aparati za mjerenje); mjerila [instrumenti za mjerenje]; mjerni instrumenti; monitori [računalni programi]; nadzor (električni uređaji za nadzor); računalni programi [radni]; računalni programi [snimljeni]		
	<b>37</b> električni aparati (postavljanje i popravak električnih aparata); popravak strujnih vodova; smetnje		

- (uklanjanje smetnji električnih instalacija); strojevi (postavljanje, održavanje i popravak strojeva)  
**42** obračun energije; pohrana elektroničkih podataka; programiranje za računala; računalni programi (održavanje računalnih programa); računalni programi [softver] (osuvremenjivanje računalnih programa); razrada tehničkih projekata; savjeti u svezi štednje energije; softver kao usluga u oblaku (SaaS); tehnološke savjetodavne usluge

(210)	Z20240105A	(220)	06.02.2024.
(731)	<b>ADNET d.o.o.</b>	(442)	15.03.2024.
(540)	Ulica Gustava Krkleca 28, 10000 Zagreb, HR		

## ADNET

- (511) **9** sadržaj koji se može preuzimati i snimati; informacijska tehnologija te uređaji za reprodukciju zvučnih zapisa, videozapisa i multimedijских sadržaja te uređaji za fotografiranje  
**42** usluge informacijske tehnologije; usluge znanosti i tehnologije; računalne usluge

## RAZRED 12

(210)	Z20231077A	(220)	09.11.2023.
(731)	<b>Neno Banić</b>	(442)	15.03.2024.
(540)	Ivana Rendića 16, 21000 Split, HR		

## Inevitable i

- (511) **12** kopnena vozila i prijevozna sredstva; električna vozila; putnička motorna vozila; samohodna električna vozila; vozila; vozila i prijevozna sredstva; vozila s automatskim upravljanjem; vozila s električnim pogonom  
**35** usluge oglašavanja, marketinga i promidžbe; usluge oglašavanja, promicanja i marketinga; davanje savjeta o potrošačkim proizvodima; pružanje informacija na internetu o prodaji automobila

## RAZRED 16

(210)	Z20231268A	(220)	22.12.2023.
(731)	<b>PLODINE d.d. za trgovinu i usluge</b>	(442)	15.03.2024.
(540)	Ružičeva 29, 51000 Rijeka, HR		



- (591) zelena, bijela, zlatna  
(531) 24.09.02; 24.09.05; 26.11.02; 26.11.11; 27.05.01; 27.05.11; 29.01.02; 29.01.03; 29.01.06  
(511) **16** folije i vrećice za zamatanje i ambalažu; folije od papira ili plastike za održavanje svježine; vrećice za pakiranje od papira ili plastike  
**32** bezalkoholno pivo; bezalkoholna jabukovača; crno pivo; jako lager pivo (Bock); lager pivo; niskoalkoholno pivo; pivo bez glutena; pivo; pivo od đumbira; pivo od slada; porter pivo; pšenično pivo; radler; svijetlo pivo  
**39** ambalažiranje i skladištenje proizvoda; zamatanje i pakiranje robe

(210)	Z20231269A	(220)	22.12.2023.
(731)	<b>PLODINE d.d. za trgovinu i usluge</b>	(442)	15.03.2024.
(540)	Ružičeva 29, 51000 Rijeka, HR		



- (591) crvena, bijela, zlatna  
(531) 24.09.02; 24.09.05; 26.11.02; 26.11.11; 27.05.01; 27.05.11; 29.01.01; 29.01.02; 29.01.06  
(511) **16** folije i vrećice za zamatanje i ambalažu; folije od papira ili plastike za održavanje svježine; vrećice za pakiranje od papira ili plastike  
**32** bezalkoholno pivo; bezalkoholna jabukovača; crno pivo; jako lager pivo (Bock); lager pivo; niskoalkoholno pivo; pivo bez glutena; pivo; pivo od đumbira; pivo od slada; porter pivo; pšenično pivo; radler; svijetlo pivo  
**39** ambalažiranje i skladištenje proizvoda; zamatanje i pakiranje robe

## RAZRED 28

(210)	Z20240034A	(220)	12.01.2024.
(731)	<b>Mattel Inc.</b>	(442)	15.03.2024.
(740)	333 Continental Blvd., El Segundo, CA 90245, US		
(540)	Vukmir i suradnici odvjetničko društvo d.o.o., Zagreb, HR		

Barbie

- (531) 27.05.01; 27.05.03; 27.05.13  
(511) **28** igračke; igre; figure u akciji - igračke; vozila - igračke; građevinske strukture - igračke; lutke; odjeća za lutke; sitni predmeti za lutke; namještaj - igračke

## RAZRED 29

(210)	Z20220472A	(220)	30.04.2022.
(731)	<b>ATELIER ECOSTYLE j.d.o.o.</b>	(442)	15.03.2024.
(740)	Zametska 94, 51000 Rijeka, HR <b>GRAD ROVINJ-ROVIGNO</b> Trg Matteotti 2, 52210 Rovinj-Rovigno, HR <b>TURISTIČKA ZAJEDNICA GRADA ROVINJA-ROVIGNO</b> Trg na mostu 2, 52210 Rovinj-Rovigno, HR <b>ZA JEDNIČKI ODVJETNIČKI URED SAŠA POLDAN, GORAN GATARA, VALENTINA VIŽINTIN, MARKO KOMORSKI, ANA ILIĆ I SOČA FRUK MORINA, Rijeka, HR</b>		
(540)			

## Rovinjska gianduja - Gianduja rovinnese

- (511) **29** namazi na bazi orašastih plodova  
**30** arome za kolače, osim eteričnih ulja; bomboni; čajni kolačići; čokolada; čokoladni moussesi [pjenice]; čokoladni namazi s orašastim plodovima; čokoladni ukrasi za kolače; kakao; kakao napici s mlijekom; kolači; makroni [kolačići od badema]; marcipan [kolač od badema]; mlijeko, čokoladno [napitak]; namazi na bazi čokolade; nugat; pasta od badema; peciva od



lisnatog tijesta s čokoladom; pića na bazi čokolade; pića na bazi kaka; praline; profiteroli [slastice]; orašasti plodovi obloženi čokoladom; sladoled; sladoledi; sladoledi na štapiću; slatkiši; slatkiši od badema; slatkiši za ukrašavanje božićnih drvca; slatkiši za ukrašavanje kolača; sorbeti [sladoledi]

33 likeri

(210) Z20231279A (220) 28.12.2023.  
(442) 15.03.2024.

(731) **PUDA d.o.o.**  
Gospodarska zona Čaporice 133, 21240 Trilj, HR



(591) crna, zelena, ljubičasta, smeđa, oker, bež, siva  
(531) 05.03.11; 25.01.01; 26.01.01; 26.01.16; 26.01.19; 27.05.01;  
27.05.10; 27.07.01; 29.01.03; 29.01.08; 29.01.12  
(511) 29 sirevi

(210) Z20231280A (220) 28.12.2023.  
(442) 15.03.2024.

(731) **PUDA d.o.o.**  
Gospodarska zona Čaporice 133, 21240 Trilj, HR



(591) crna, ljubičasta, zelena, roza, siva  
(531) 05.05.07; 05.05.19; 25.01.01; 26.01.01; 26.01.16; 26.01.19;  
27.05.01; 27.05.10; 27.07.01; 29.01.05; 29.01.08  
(511) 29 sirevi

(210) Z20231281A (220) 28.12.2023.  
(442) 15.03.2024.

(731) **PUDA d.o.o.**  
Gospodarska zona Čaporice 133, 21240 Trilj, HR



(591) crna, žuta, smeđa, bež, oker, zelena, siva  
(531) 05.05.18; 05.05.19; 25.01.01; 26.01.01; 26.01.16; 26.01.19;  
27.05.01; 27.05.10; 29.01.02; 29.01.03; 29.01.08  
(511) 29 sirevi

(210) Z20240164A (220) 21.02.2024.  
(442) 15.03.2024.

(731) **PIK VRBOVEC plus d.o.o.**  
Zagrebačka ulica 148, 10340 Vrbovec, HR  
(740) Odvjetničko društvo Vukina & Partneri d.o.o., Zagreb, HR  
(540)



(591) crvena, bijela  
(531) 29.01.01; 14.09.01; 14.09.02; 27.05.01; 29.01.06; 02.09.01  
(511) 29 meso i mesni proizvodi; obrađeni mesni proizvodi;  
pakirano meso; suho meso; svježe meso; salame;  
kobasice; šunka; mortadela; parizer

(210) Z20240165A (220) 21.02.2024.  
(442) 15.03.2024.

(731) **PIK VRBOVEC plus d.o.o.**  
Zagrebačka ulica 148, 10340 Vrbovec, HR  
(740) Odvjetničko društvo Vukina & Partneri d.o.o., Zagreb, HR  
(540)



(591) crvena, bijela  
(531) 21.01.01; 14.09.01; 14.09.02; 27.05.01; 29.01.01; 29.01.06;  
02.09.01  
(511) 29 meso i mesni proizvodi; obrađeni mesni proizvodi;  
pakirano meso; suho meso; svježe meso; salame;  
kobasice; šunka; mortadela; parizer

## RAZRED 30

(210) Z20231089A (220) 09.11.2023.  
(442) 15.03.2024.

(731) **FITSTOP BAR j.d.o.o.**  
Trg 101. brigade Hrv. vojske 2, 10090 Zagreb, HR  
(540)



(591) crna, bijela, zelena, žuta, narančasta, tamno crvena, smeđa  
(531) 05.09.24; 26.01.01; 26.01.15; 26.01.19; 26.01.20; 27.01.01;  
27.01.06; 27.05.01; 29.01.15

(511) 30 kruh; peciva; kolači i slastice od organski uzgojenih  
sastojaka; kukuruzne pahuljice; pahuljice od sušenih  
žitarica; musli; zobene pahuljice; ocat  
32 bezalkoholna pića; bezalkoholna pića koja sadrže  
voće; bezalkoholna pića s okusom čaja; bezalkoholni  
napitci od suhog voća; bezalkoholni voćni ekstrakti;  
trapei od voća [smoothies]; koncentri od voća bez

- alkohola; mošt; nektar, voćni; sokovi, biljni [napici]; voćni napici bez alkohola; voćni sokovi
- 35 maloprodajne usluge u vezi s prehrambenim proizvodima; veleprodajne usluge u vezi s prehrambenim proizvodima
- 43 usluge okrepe; usluge pripremanja hrane i pića; pružanje hrane i pića; usluge opskrbe hranom i pićem u mobilnom restoranu-kamionu; usluge bistrea; usluge banketa i osiguravanje hrane i pića (katering); serviranje hrane i pića; hranjenje; kavane restorani; restorani sa samoposluživanjem; restorani za brzo i stalno posluživanje (snek barovi)

(210)	Z20231284A	(220)	29.12.2023.
(731)	<b>Reizl d.o.o.</b>	(442)	15.03.2024.
(740)	Ulica Ivana Lukačića 2A, 10260 Sesvete, HR		
(540)	Odvjetničko društvo Planinić, Šoljić i partneri d.o.o., Zagreb, HR		

## REIZL

- (511) 30 aperitiv keksi; aromatizirani sladoledi; aromatizirani šećerni konditorski proizvodi; aromatski pripravci za sladolede; arome dobivene od voća; arome dobivene od voća [osim esencijalnih ulja]; arome vanilije za kulinarske potrebe; arome vanilije; arome za grickalice [osim esencijalnih ulja]; bademi u čokoladi; bademovi kolačići; arome za kolače; bezmliječna čokolada; bezglutenski pekarski proizvodi; biljno-medne pastile [slatkiši]; biskvit; bomboni bez šećera; bomboni koji nisu za medicinske svrhe; bomboni na bazi paprene metvice [pepermint bomboni]; bomboni (nemedicinski -); bomboni (nemedicinski -) u vidu karamela; bomboni od crvenog ginsenga; bomboni od kukuruznog sirupa; bomboni od šećera; bomboni od mentola [osim za medicinsku uporabu]; bomboni s kakaom; bomboni od sladića sa sol- amonijakom (nemedicinski -); bomboni s karamelom; bomboni [šećer]; bomboni [slatkiši]; bomboni za ukrašavanje kolača; bomboni za žvakanje; bomboni za žvakanje na bazi želatine; brašno od žitarica; brašno od prženih žitarica; brioshi; brioshi punjeni džemom; brownies [kolači od čokolade]; čips od žitarica; čips na bazi žita; čips na bazi brašna; čokolada s alkoholom; čokolada s japanskim hrenom; čokolada s mjehurićima zraka; čokolada u obliku pralina; čokolada u prahu; čokolada za konditorske proizvode i kruh; čokolada za piće; čokolada za preljeve; čokolade s punjenjem od metvice; čokolade u obliku morskih konjica; čokolade u obliku morskih školjki; čokoladice koje sadrže mješavinu žitarica, orašćica i osušenog voća [konditorske]; čokoladice u adventskom kalendaru; čokoladna jaja; čokoladna kava; čokoladna prehrambena pića koja nisu na mliječnoj ili biljnoj bazi; čokoladna punjenja za pekarske proizvode; čokoladne arome; čokoladne dekoracije za kolače; čokoladne esencije za pripremu pića; čokoladne kapljice; čokoladne kore koje sadrže mljevena zrna kave; čokoladne kreme; čokoladne mrvice; čokoladne oblatne; čokoladne paste; čokoladne praline; čokoladne školjke; čokoladne slastice; čokoladni bombon s punjenjem; čokoladne torte; čokoladni bomboni; čokoladni deserti; čokoladni ekstrakti; čokoladni ekstrakti za pripremu pića; čokoladni fonditi; čokoladni fudge [mekani slatkiši od šećera, maslaca, mlijeka i jaja]; čokoladni keksi; čokoladni kolači; čokoladni konditorski proizvodi koji imaju okus pralina; čokoladni konditorski proizvodi koji sadržavaju praline; čokoladni marzipan; čokoladni musevi [pjenice]; čokoladni namazi; čokoladni namazi za kruh; čokoladni napitak s mlijekom; čokoladni orašasti plodovi; čokoladni prutići; čokoladni preljev; čokoladni sirup; čokoladni sirupi za pripremanje pića na bazi čokolade; čokoladni slatkiši; čokoladni tartufi; čokoladni tartufi [konditorski]; čokoladni tartufi s rumom [konditorski]; čokoladni ukrasi za božićna drvca; čokoladni ukrasi za konditorske proizvode; čokoladni umak; čokoladni vafli; čokoladni zečići; desertni moussevi [slastičarski proizvodi]; cupcakes; crumble [britanski kolač od voća i žitarica]; ekstrakti kaka kao arome za pića; ekstrakti kaka kao arome za hranu; desertni musevi [slastičarski proizvodi]; desertni nabujci; donutsi; ekstrudirane grickalice koje sadrže kukuruz; engleski mafini; fondani (bomboni) [konditorski proizvodi]; glazura za kolače; glazura; gotove grickalice na bazi žitarica; gotove slane

grickalice od kukuruzne krupice dobivene ekstruzijom; gotovi deserti [na bazi čokolade]; gotovi deserti [konditorski proizvodi]; gotovi deserti [tijesta]; gotovi kakao i pića na bazi kaka; grickalice koje se sastoje od proizvoda žitarica; grickalice koje se uglavnom sastoje od ekstrudiranih žitarica; grickalice koje se uglavnom sastoje od slatkiša; grickalice koje se uglavnom sastoje od kruha; grickalice koje se uglavnom sastoje od riže; grickalice koje se uglavnom sastoje od tjestenine; grickalice koje se uglavnom sastoje od zrna žitarica; grickalice na bazi brašna; grickalice na bazi kukuruza; grickalice na bazi pšenice; grickalice na bazi riže; grickalice na bazi više žitarica; grickalice od brašna žitarica; grickalice od brašna krumpira; grickalice od kreker tosta; grickalice od žitarica; grickalice od ekstrudirane pšenice; grickalice od cjelovitog zrna pšenice; grickalice od kukuruza; grickalice od kukuruznog brašna; grickalice od pšenice; grickalice proizvedene od mueslija; grickalice proizvedene od žitarica; grickalice pripremljene od kukuruza; gumeni bomboni (nemedicinski -); gumeni bomboni; hrana koja sadržava čokoladu [kao glavni sastojak]; hrana koja sadržava kakao [kao glavni sastojak]; hrana na bazi kaka; hrana na bazi zobi za ljudsku konzumaciju; hrana napravljena od pečenih žitarica; hrana od kukuruza; hrana od žitarica; imitacija čokolade; imitacija kreme od vanilije; instant mješavine za palačinke; instant mješavine za puding; instant mješavine za sladoled; kakao ekstrakti za konzumaciju; kakao mješavine; kakao pića; kakao pripravci; kakao pripravci za pravljenje pića; kakao [pržen, u prahu, u granulama ili u pićima]; kakao u prahu; kakao za pripremanje pića; kandirani kolači od napuhane riže; kaneloni; karamel [uprženi šećer]; karamela; karamele; karamelizirane kokice; karamelizirani šećer; kaše od povrća [umaci-hrana]; kaše na bazi mlijeka sa žitaricama (za prehranu); keksi s preljevom od čokolade; keksi s okusom voća; keksi s maslacem; keksi s glazurom; keksi preliveni premazom s okusom čokolade; keksi; keksi koji sadrže sastojke s okusom čokolade; keksi koji sadrže voće; keksi napola prekriveni čokoladom; keksi od prženog tijesta (karintoh); keksi od riže; keksi od slada; keksi od zobenih pahuljica; keksi prekriveni čokoladom; keksi preliveni čokoladom; keksi [slatki ili slani]; keksi za ljudsku potrošnju pripremljeni od slada; keksi za ljudsku potrošnju pripremljeni od žitarica; kokice prelivene šećerom; kolač od melase; kokosove puslice; kokosovo brašno za ljudsku ishranu; kolači od ljepljive riže (chapsaltock); kolači od prosa; kolači od prženog tijesta; kolači od slada; kolači od šljiva; kolači od smrznutog jogurta; kolači od žitarica za ljudsku potrošnju; kolači (prašak za kolače); kolači preliveni čokoladom; kolači punjeni kremom [eclairs]; kolači (tijesto za kolače); kolači u obliku pločica; kolači za doručak; kolačići; kolačići na štapiću; kolačići od riže kao grickalice; kolačići od riže preliveni čokoladom; kolačići sreće; konditorske pločice; konditorski proizvodi na bazi naranče; konditorski proizvodi (nemedicinski); konditorski proizvodi od orašćica; konditorski proizvodi od sladoleda; konditorski proizvodi od čokolade; konditorski proizvodi preliveni čokoladom; konditorski proizvodi od sljeza; konditorski proizvodi s glazurom (nemedicinski -); konditorski proizvodi s okusom čokolade; konditorski proizvodi sa slatkim preljevom; konditorski proizvodi u obliku pastila; krafne; krekeri [jestiv]; krekeri s okusom voća; krekeri od pripremljenih žitarica; kristalizirani šećer za ukrašavanje kolača; kristalizirani šećer za ukrašavanje hrane; krokanti; krokant od kikirikija; kruh od više vrsta žitarica; kruh i peciva; kruh bez glutena; ledena pića na bazi čokolade; ledena pića na bazi kaka; ledena torta; ledeni slatkiši; ledeni voćni štapići; ledeni konditorski proizvodi; lizalice; lizalice [konditorski proizvodi]; makaroni - francuski kolač; makadamia orašćići obloženi čokoladom; makaroni [nekuhani]; marshmallow; marshmallow čokoladice; marshmallow kolači s preljevom od čokolade koji sadrže karamel; marshmallow preljev; marshmallow slastice; marshmallow krema; mekane karamele; mekani pereci; mekani sladoled; mekana peciva [kruh]; mekani slatkiš od šećera, maslaca i mlijeka; mješavina za vruću čokoladu; mješavina za kolače; mješavine za muffine; mješavine za kekse; mješavine za kolače; mješavine za krafne; mješavine za kremu od vanilije; mješavine za glazure; mješavine za donutse; mješavine za čokoladne kolače; mješavine za palačinke; mješavine za pripremanje sherbeta; mješavine za pripremu konditorskih proizvoda sa sladoledom; mješavine za pripremu pudinga;

mješavine za pripremu sladoleda; mješavine za šećernu glazuru; mješavine za sladoled; mješavine za sladoledne kornete; mješavine za slastice od tijesta; mješavine za začinjene palačinke; mliječni sladoled; mliječne čokolade; mliječni konditorski proizvodi; mliječni bomboni u obliku tableta; musli; musli deserti; namaz za sendvič od čokolade i oraščića; namazi na bazi kreme od nugata; nadomjestak za sladoled na bazi soje; muffini; muesli koji se uglavnom sastoje od žitarica; napolitanke [hrana]; napolitanke s čokoladnim karamelom; napolitanke prelivene čokoladom; nemedicinska čokolada; nemedicinski bomboni; nemedicinski bomboni s alkoholom; nemedicinski bomboni s medom; nemedicinski bomboni s metvicom; nemedicinski čokoladni konditorski proizvodi; nemedicinski konditorski proizvodi od brašna koji sadrže čokoladu; nemedicinski konditorski proizvodi u obliku pastila; nemedicinski konditorski proizvodi od brašna prekriveni čokoladom; nemedicinski konditorski proizvodi kao dio kalorijski kontrolirane dijeta; nemedicinski konditorski proizvodi sa čokoladom; nemedicinski konditorski bomboni; nemedicinski konditorski proizvodi; nemedicinski konditorski proizvodi od brašna koji sadržavaju imitaciju čokolade; nemedicinski konditorski proizvodi s mlijekom; nemedicinski konditorski proizvodi s punjenjem od karamela; nemedicinski konditorski proizvodi od brašna premazani imitacijom čokolade; nemedicinski slatkiši; nemedicinski slatkiši za žvakanje; nonpareils ukrašeni kolačići; nugat pločice s preljevom od čokolade; obrađene žitarice; obrađena zob za prehranu za ljudsku konzumaciju; obrađena zrna žitarica; okrugle pite od jabuka; okrugli keksi s đumbirom; obrađene žitarice za hranu za ljudsku konzumaciju; otvorene pite (sa slatkim ili slanim nadjevom); otvorene pite [slatke ili slane]; pahuljice, zobene; pahuljice [zobene -]; panetone [božićni talijanski kolač s grožđicama]; panetone [vrsta dizanog kolača s grožđicama]; pastila [slastice]; pastile [bomboni]; pastile [nemedicinski konditorski proizvodi]; pastile [nisu za medicinske svrhe]; peciva; peciva od badema; peciva punjena voćem; pecivo; pecivo od lisnatog tijesta; pekarske slastice; pekarski proizvodi; pekarski proizvodi sa sjemenkama maka; pepermint bomboni bez šećera; pepermint bomboni [osim za medicinsku uporabu]; pepermint pastile [konditorske], osim za medicinsku uporabu; pepermint slatkiši [osim za medicinsku uporabu]; pereci prekriveni čokoladom; pereci preliveni čokoladom; pereci; pića koja sadrže čokoladu; pića koja se uglavnom sastoje od čokolade; pića koja se uglavnom sastoje od kaka; pića koja sadrže kakao; pića na bazi čokolade; pića na bazi kave koja sadrže mlijeko; pića na bazi kave koja sadrže sladoled (affogato); pića od sladoleda; pića pripremljena od čokolade; pića s aromom čokolade; pića pripremljena od kaka; pića s okusom čokolade; pića s mlijekom na bazi čokolade; pića sa čokoladom; pića u prahu koja sadrže kakao; pjenaste šećerne pastile; pjenasti bomboni; pjenasti šećerni slatkiši; pločice na bazi čokolade kao zamjena za obrok; pločice na bazi pšenice; pločice na bazi žitarica kao zamjena za obrok; pločice od mliječne čokolade; pločice od žitarica; pločice od žitarica i energetske pločice; pločice prelivene čokoladom; praline od čokolade; praline s tekućim punjenjem; prehrambeni proizvodi na bazi šećera za pravljenje deserta; prehrambeni pripravci na bazi slada; prehrambeni pripravci na bazi žita; prehrambene pločice na bazi žitarica; prehrambene pločice na bazi čokolade [gotove za potrošnju]; prehrambeni proizvodi na bazi šećera za zaslađivanje deserta; prehrambeni proizvodi na bazi zaslađivača za pravljenje deserta; premaz s okusom čokolade; prerađene žitarice, škrob i njihovi proizvodi, pripravci za pečenje i kvasci; princes krafne; pripravci na bazi žitarica za poboljšanje kruha; pripravci na bazi kaka; pripravci od žitarica; pripravci od žitarica prekriveni šećerom i medom; pripravci u prahu koji sadržavaju kakao za pripremu napitaka; pripravci za čokoladna pića s okusom banane; pripravci za čokoladna pića s okusom karamela; pripravci za čokoladna pića; pripravci za čokoladna pića s okusom metvice; pripravci za čokoladna pića s okusom oraščića; pripravci za čokoladna pića s okusom naranče; pripravci za čokoladna pića s okusom moke; pripravci za izradu slatkiša; pripravci za pića s okusom čokolade; pripravci za pravljenje umaka; pripravci za pripremu napitaka [na bazi kaka]; pripravci za pripremu napitaka [na bazi kave]; pripravci za pripremu napitaka [na bazi čaja];

pripravci za pripremu napitaka [na bazi čokolade]; pripravci za pripremu pekarskih proizvoda; pripravci za pripremu torti (gateaux); pripravci za pripremu vafli; pripravci žitarica koji se sastoje od zobenih mekinja; pripravci žitarica koji se sastoje od mekinja; pripravci žitarica koji sadržavaju zobene mekinje; prirodne rižine pahuljice; proizvodi na bazi čokolade; proizvodi od kaka; proso (obrađene žitarice); pšenične pahuljice; pudinzi kao deserti; punjena čokolada; pudinzi u prahu; punjene čokoladice; punjene karamele; punjeni slatkiši; punjenja na bazi čokolade; punjenja za kolače i pite na bazi čokolade; punjenja za kolače i pite na bazi kreme od vanilije; rolane oblatne [keksi]; rolade od pekan- oraha; rolani keksi na bazi jajeta; ručno izrađeni bomboni; rožate; šećeri, prirodni zaslađivači, slatke glazure i punjenja, pčelinji proizvodi; šećerna vuna; šećerni bomboni (nemedicinski -); šećerni bomboni [za prehranu]; šećerni konditorski proizvodi (nemedicinski -); šećerni štapići; sirup za palačinke; sirup za preljev; škotski kolačići s preljevom okusa čokolade; škotski kolačići s čokoladnim preljevom; škotski kolačići napola prekriveni čokoladom; škotski kolačići s preljevom s čokoladnom aromom; škotske slastice [u obliku tablica]; škotski kolačići djelomično prekriveni preljevom s aromom čokolade; sladoled; sladoled bez mlijeka; sladoled na bazi jogurta [sladoled prevladava]; sladoled nadopljen alkoholom; sladoled s tartufima; sladoled s voćem; sladoled (vezivna sredstva za -); sladoledi; sladoledi koje sadrže mlijeko; sladoledi koji sadrže čokoladu; sladoledi na bazi soje; slane grickalice na bazi brašna; sladoledi s aromom mlijeka; sladoledi s okusom čokolade; sladoledi, smrznuti jogurti i sorbeti; sladoledni deserti; sladoledni sendviči; slane arome za hranu [osim esencijalnih ulja]; slastice [bomboni]; slastičarske kapljice za pečenje; slastice od tijesta koje sadrže kreme i voće; slastice od tijesta koje sadrže voće; slastice od tijesta koje sadrže kreme; slastice od tijesta s voćem; slastice od zamrznutog jogurta; slastice s niskim udjelom ugljikohidrata; slastice, torte, pite i keksi; slatke glazure; slatke glazure i punjenja; slatke kokice; slatke pločice; slatki keksi za ljudsku konzumaciju; slatki namazi [med]; slatkiši; slatkiši bez šećera; slatkiši [bombon] aromatizirani voćem; slatkiši [bomboni]; slatkiši [bombon] koji sadrže voće; slatkiši (bomboni), čokoladice i guma za žvakanje; slatkiši (nemedicinski -); slatkiši na bazi metvice (nemedicinski); slatkiši (nemedicinski -) - čokoladni ekleri; slatkiši (nemedicinski -) koji sadrže biljne arome; slatkiši (nemedicinski -) na bazi meda; slatkiši (nemedicinski -) - nugat; slatkiši (nemedicinski -) na bazi alkohola; slatkiši (nemedicinski -) - šećerni konditorski proizvodi; slatkiši (nemedicinski -) u komprimiranom obliku; slatkiši (nemedicinski -) u obliku bombona; slatkiši s čokoladnim preljevom; slatkiši s okusom metvice (nemedicinski -); slatkiši sa kuhanim šećerom; slatkiši s preljevom (nemedicinski -); slatkiši za dekoraciju kolača; slatkiši za ukrašavanje kolača; smjesa za palačinke; smrznute palačinke; smrznuti mliječni desert u obliku pločice; smrznuti vafli; smrznuto tijesto za biscotti kekse; smrznuto tijesto za čokoladne kolače [brownies]; štapići od sladića [slatkiši]; štapići cimeta; štapići vanilije; staklasta glazura [staklasti preljev]; tekući konditorski proizvodi; tijesto za keks; tijesto za kekse biscotti; tijesto za brownije; tijesto za palačinke; topla čokolada; tople žitarice za doručak; torta od badema; torta sa slatkišima; torte; torte od jagoda; torte od sira; torte od sladoleda; torte s glazurom; tradicionalni korejski komprimirani slatkiši [dasik]; tradicionalne engleske pite sa šećernim sirupom i mrvicama; tradicionalne britanske božićne pite od voća; trajna peciva; turski rahat lokum; turski rahat lokum prelivene čokoladom; tvrde karamele prelivene šećerom; tvrdi bomboni; tvrde karamele [bomboni]; umaci za sladoled; umak od brusnica [kondiment]; umak od jabuka [kondiment]; ušećerani bademi; ušećerani pinjoli; vafli s čokoladnim preljevom; vanilija; veganska vruća čokolada; veganski kolačići; veganski sladoled; visoka čokoladna torta sa čokoladnim spužvastim biskvitom; voće s preljevom od čokolade; voćne arome, osim esencija; voćne arome, osim esencijalnih ulja; voćni bomboni [konditorski proizvod]; voćni gumeni bomboni [za nemedicinsku uporabu]; voćni jestivi sladoledi; voćni kolačići; voćni kolači s glazurom; voćni kolačići; voćni šećer; voćni sladoled; voćni sladoledi; voda narančinog cvijeta za kulinarske potrebe; vodeni sladoledi na štapiću s voćnom aromom; vodeni sladoled; vruća čokolada; začinjene palačinke; zamjene za čokoladu; zamjena za sladoled; zamjene za kakao; zamrznuti kolačići; zamrznuta peciva;

zamrznuta krema od vanilije; zamrznuti konditorski proizvodi koji sadržavaju sladoled; zamrznuti konditorski proizvodi; zamrznuti konditorski proizvodi na štapiću; zamrznuti mliječni konditorski proizvodi; zaslađivači koji se sastoje od voćnih koncentrata; zamrznuto tijesto za keks; zefir [slastice]; zatvorena pita od prhkog tijesta; zaslađivači (prirodni -) u granulama; žele bomboni (jelly beans); žitarice; žitarice, kaša i krupice za doručak; žitarice pripremljene za konzumaciju ljudi; žitarice spremne za jelo; žitarice u prahu; žitarice za doručak; žitarice za doručak koje sadrže mješavinu voća i vlakana; žitarice za doručak koje sadrže med; žitarice za doručak koje sadrže vlakna; žitarice za doručak koje sadrže voće; žitarice za doručak od riže; žitarice za doručak s okusom meda; žitarice za prehranu ljudi; žitne pločice; zob za kašu; zobena kaša; zobena kaša za ljudsku konzumaciju; zobene i pšenične pahuljice; zobene pahuljice; zobene pločice; zobeni keksi za ljudsku konzumaciju; zobeni kolači za ljudsku konzumaciju; žvakaće gume za osvežavanje daha; žvakaće gume [nisu za medicinske potrebe]; žvakaće gume; žvakaća guma zdrava za zube [nemedicinska]; žvakaća guma bez šećera

čokoladne praline; čokoladne školjke; čokoladne slastice; čokoladni bombon s punjenjem; čokoladne torte; čokoladni bomboni; čokoladni deserti; čokoladni ekstrakti; čokoladni ekstrakti za pripremu pića; čokoladni fond; čokoladni fudge [mekani slatkiši od šećera, maslaca, mljeka i jaja]; čokoladni keksi; čokoladni kolači; čokoladni konditorski proizvodi koji imaju okus pralina; čokoladni konditorski proizvodi koji sadržavaju praline; čokoladni marcipan; čokoladni musevi [pjenice]; čokoladni namazi; čokoladni namazi za kruh; čokoladni napitak s mlijekom; čokoladni orašasti plodovi; čokoladni prutiči; čokoladni preljev; čokoladni sirup; čokoladni sirupi za pripremanje pića na bazi čokolade; čokoladni slatkiši; čokoladni tartufi; čokoladni tartufi [konditorski]; čokoladni tartufi s rumom [konditorski]; čokoladni ukrasi za božićna drvca; čokoladni ukrasi za konditorske proizvode; čokoladni umak; čokoladni vafli; čokoladni zečiči; desertni moussevi [slastičarski proizvodi]; cupcakes; crumble [britanski kolač od voća i žitarica]; ekstrakti kakaa kao arome za piće; ekstrakti kakaa kao arome za hranu; desertni musevi [slastičarski proizvodi]; desertni nabujci; donutsi; ekstrudirane grickalice koje sadrže kukuruz; engleski mafini; fondani (bomboni) [konditorski proizvodi]; glazura za kolače; glazura; gotove grickalice na bazi žitarica; gotove slane grickalice od kukuruzne krupice dobivene ekstruzijom; gotovi deserti [na bazi čokolade]; gotovi deserti [konditorski proizvodi]; gotovi deserti [tijesta]; gotovi kakao i pića na bazi kakaa; grickalice koje se sastoje od proizvoda žitarica; grickalice koje se uglavnom sastoje od ekstrudiranih žitarica; grickalice koje se uglavnom sastoje od slatkiša; grickalice koje se uglavnom sastoje od kruha; grickalice koje se uglavnom sastoje od riže; grickalice koje se uglavnom sastoje od tjestenine; grickalice koje se uglavnom sastoje od zrna žitarica; grickalice na bazi brašna; grickalice na bazi kukuruza; grickalice na bazi pšenice; grickalice na bazi riže; grickalice na bazi više žitarica; grickalice od brašna žitarica; grickalice od brašna krumpira; grickalice od kreker tosta; grickalice od žitarica; grickalice od ekstrudirane pšenice; grickalice od cjelovitog zrna pšenice; grickalice od kukuruza; grickalice od kukuruznog brašna; grickalice od pšenice; grickalice proizvedene od mueslija; grickalice proizvedene od žitarica; grickalice pripremljene od kukuruza; gumeni bomboni (nemedicinski -); gumeni bomboni; hrana koja sadržava čokoladu [kao glavni sastojak]; hrana koja sadržava kakao [kao glavni sastojak]; hrana na bazi kakaa; hrana na bazi zobi za ljudsku konzumaciju; hrana napravljena od pečenih žitarica; hrana od kukuruza; hrana od žitarica; imitacija čokolade; imitacija kreme od vanilije; instant mješavine za palačinke; instant mješavine za pudding; instant mješavine za sladoled; kakao ekstrakti za konzumaciju; kakao mješavine; kakao pića; kakao pripravci; kakao pripravci za pravljenje pića; kakao [pržen, u prahu, u granulama ili u pićima]; kakao u prahu; kakao za pripremanje pića; kandirani kolači od napuhane riže; kaneloni; karamel [uprženi šećer]; karamela; karamele; karamelizirane kokice; karamelizirani šećer; kaše od povrća [umaci-hrana]; kaše na bazi mljeka sa žitaricama (za prehranu); keksi s preljevom od čokolade; keksi s okusom voća; keksi s maslacem; keksi s glazurom; keksi preliveni premazom s okusom čokolade; keksi; keksi koji sadrže sastojke s okusom čokolade; keksi koji sadrže voće; keksi napola prekriveni čokoladom; keksi od prženog tijesta (karintoh); keksi od riže; keksi od slada; keksi od zobenih pahuljica; keksi prekriveni čokoladom; keksi preliveni čokoladom; keksi [slatki ili slani]; keksi za ljudsku potrošnju pripremljeni od slada; keksi za ljudsku potrošnju pripremljeni od žitarica; kokice prelivene šećerom; kolač od melase; kokosove puslice; kokosovo brašno za ljudsku ishranu; kolači od ljepilive riže (chapsalttock); kolači od prosa; kolači od prženog tijesta; kolači od slada; kolači od šljiv; kolači od smrznutog jogurta; kolači od žitarica za ljudsku potrošnju; kolači (prašak za kolače); kolači preliveni čokoladom; kolači punjeni kremom [eclairs]; kolači (tijesto za kolače); kolači u obliku pločica; kolači za doručak; kolačići; kolačići na štapiću; kolačići od riže kao grickalice; kolačići od riže preliveni čokoladom; kolačići sreće; konditorske pločice; konditorski proizvodi na bazi naranče; konditorski proizvodi (nemedicinski); konditorski proizvodi od orašića; konditorski proizvodi od sladoleda; konditorski proizvodi od čokolade; konditorski proizvodi preliveni čokoladom; konditorski proizvodi od sljeza; konditorski proizvodi s glazurom (nemedicinski -); konditorski

(210)	Z20231285A	(220)	29.12.2023.
(731)	<b>Reizl d.o.o.</b>	(442)	15.03.2024.
(740)	Ulica Ivana Lukačića 2A, 10260 Sesvete, HR		
(540)	Odvjetničko društvo Planinić, Šoljić i partneri d.o.o., Zagreb, HR		



(591) zelena, svijetlo zelena, tamno zelena, bijela

(531) 05.03.11; 05.03.13; 26.01.01; 26.01.15; 26.01.16; 26.01.18; 27.05.01; 27.05.09; 27.05.10; 27.05.21; 29.01.03; 29.01.06

(511) **30** aperitiv keksi; aromatizirani sladoledi; aromatizirani šećerni konditorski proizvodi; aromatski pripravci za sladolede; arome dobivene od voća; arome dobivene od voća [osim esencijalnih ulja]; arome vanilije za kulinarske potrebe; arome vanilije; arome za grickalice [osim esencijalnih ulja]; bademi u čokoladi; bademovi kolačići; arome za kolače; bezmliječna čokolada; bezglutenski pekarski proizvodi; biljno-medne pastile [slatkiši]; biskvit; bomboni bez šećera; bomboni koji nisu za medicinske svrhe; bomboni na bazi paprene metvice [pepermint bomboni]; bomboni (nemedicinski -); bomboni (nemedicinski -) u vidu karamela; bomboni od crvenog ginsenga; bomboni od kukuruznog sirupa; bomboni od šećera; bomboni od mentola [osim za medicinsku uporabu]; bomboni s kakaom; bomboni od sladića sa sol- amonijakom (nemedicinski -); bomboni s karamelom; bomboni [šećer]; bomboni [slatkiši]; bomboni za ukrašavanje kolača; bomboni za žvakanje; bomboni za žvakanje na bazi želatine; brašno od žitarica; brašno od prženih žitarica; brioshi; brioshi punjeni džemom; brownies [kolači od čokolade]; čips od žitarica; čips na bazi žita; čips na bazi brašna; čokolada s alkoholom; čokolada s japanskim hrenom; čokolada s mjehurićima zraka; čokolada u obliku pralina; čokolada u prahu; čokolada za konditorske proizvode i kruh; čokolada za piće; čokolada za preljeve; čokolade s punjenjem od metvice; čokolade u obliku morskih konjica; čokolade u obliku morskih školjki; čokoladice koje sadrže mješavinu žitarica, orašića i osušenog voća [konditorske]; čokoladice u adventskom kalendaru; čokoladna jaja; čokoladna kava; čokoladna prehrambena pića koja nisu na mliječnoj ili biljnoj bazi; čokoladna punjenja za pekarske proizvode; čokoladne arome; čokoladne dekoracije za kolače; čokoladne esencije za pripremu pića; čokoladne kapljice; čokoladne kore koje sadrže mljevena zrna kave; čokoladne kreme; čokoladne mrvice; čokoladne oblatne; čokoladne paste;

proizvodi s okusom čokolade; konditorski proizvodi sa slatkim preljevom; konditorski proizvodi u obliku pastila; krafne; krekeri [jestivi]; krekeri s okusom voća; krekeri od pripremljenih žitarica; kristalizirani šećer za ukrašavanje kolača; kristalizirani šećer za ukrašavanje hrane; krokanti; krokant od kikirikija; kruh od više vrsta žitarica; kruh i peciva; kruh bez glutena; ledena pića na bazi čokolade; ledena pića na bazi kaka; ledene torte; ledeni slatkiši; ledeni voćni štapići; ledeni konditorski proizvodi; lizalice; lizalice [konditorski proizvodi]; makaroni - francuski kolač; makadamia orašiči obloženi čokoladom; makaroni [nekuhani]; marshmallow; marshmallow čokoladice; marshmallow kolači s preljevom od čokolade koji sadrže karamel; marshmallow preljev; marshmallow slastice; marshmallow krema; mekane karamele; mekani pereci; mekani sladoled; mekana peciva [kruh]; mekani slatkiš od šećera, maslaca i mlijeka; mješavina za vruću čokoladu; mješavina za kolače; mješavine za muffine; mješavine za kekse; mješavine za kolače; mješavine za krafne; mješavine za kremu od vanilije; mješavine za glazure; mješavine za donutse; mješavine za čokoladne kolače; mješavine za palačinke; mješavine za pripremanje sherbeta; mješavine za pripremu konditorskih proizvoda sa sladoledom; mješavine za pripremu pudinga; mješavine za pripremu sladoleda; mješavine za šećernu glazuru; mješavine za sladoled; mješavine za sladoledne kornete; mješavine za slastice od tijesta; mješavine za začinjene palačinke; mliječni sladoled; mliječne čokolade; mliječni konditorski proizvodi; mliječni bomboni u obliku tableta; musli; musli deserti; namaz za sendvič od čokolade i orašiča; namazi na bazi kreme od nugata; nadomjestak za sladoled na bazi soje; muffini; muesli koji se uglavnom sastoje od žitarica; napolitanke [hrana]; napolitanke s čokoladnim karamelom; napolitanke prelivene čokoladom; nemedicinska čokolada; nemedicinski bomboni; nemedicinski bomboni s alkoholom; nemedicinski bomboni s medom; nemedicinski bomboni s metvicom; nemedicinski čokoladni konditorski proizvodi; nemedicinski konditorski proizvodi od brašna koji sadrže čokoladu; nemedicinski konditorski proizvodi u obliku pastila; nemedicinski konditorski proizvodi od brašna prekriveni čokoladom; nemedicinski konditorski proizvodi kao dio kalorijski kontrolirane dijeta; nemedicinski konditorski proizvodi sa čokoladom; nemedicinski konditorski bomboni; nemedicinski konditorski proizvodi od brašna koji sadržavaju imitaciju čokolade; nemedicinski konditorski proizvodi s mlijekom; nemedicinski konditorski proizvodi s punjenjem od karamele; nemedicinski konditorski proizvodi od brašna premazani imitacijom čokolade; nemedicinski slatkiši; nemedicinski slatkiši za žvakanje; nonpareils ukrašeni kolačići; nugat pločice s preljevom od čokolade; obrađene žitarice; obrađena zob za prehranu za ljudsku konzumaciju; obrađena zrna žitarica; okrugle pite od jabuka; okrugli keksi s dumbirom; obrađene žitarice za hranu za ljudsku konzumaciju; otvorene pite (sa slatkim ili slanim nadjevom); otvorene pite [slatke ili slane]; pahuljice, zobene; pahuljice [zobene -]; panetone [božićni talijanski kolač s grožđicama]; panetone [vrsta dizanog kolača s grožđicama]; pastila [slastice]; pastile [bomboni]; pastile [nemedicinski konditorski proizvodi]; pastile [nisu za medicinske svrhe]; peciva; peciva od badema; peciva punjena voćem; pecivo; pecivo od lisnatog tijesta; pekarske slastice; pekarski proizvodi; pekarski proizvodi sa sjemenkama maka; pepermint bomboni bez šećera; pepermint bomboni [osim za medicinsku uporabu]; pepermint pastile [konditorske], osim za medicinsku uporabu; pepermint slatkiši [osim za medicinsku uporabu]; pereci prekriveni čokoladom; pereci preliveni čokoladom; pića koja sadrže čokoladu; pića koja se uglavnom sastoje od čokolade; pića koja se uglavnom sastoje od kaka; pića koja sadrže kaka; pića na bazi čokolade; pića na bazi kave koja sadrže mlijeko; pića na bazi kave koja sadrže sladoled (affogato); pića od sladoleda; pića pripremljena od čokolade; pića s aromom čokolade; pića pripremljena od kaka; pića s okusom čokolade; pića s mlijekom na bazi čokolade; pića sa čokoladom; pića u prahu koja sadrže kaka; pjenaste šećerne pastile; pjenasti bomboni; pjenasti šećerni slatkiši; pločice na bazi čokolade kao zamjena za obrok; pločice na bazi pšenice; pločice na bazi žitarica kao zamjena za obrok; pločice od mliječne čokolade; pločice od žitarica; pločice od žitarica i energetske pločice; pločice prelivene čokoladom; praline od

čokolade; praline s tekućim punjenjem; prehrambeni proizvodi na bazi šećera za pravljenje deserta; prehrambeni pripravci na bazi slada; prehrambeni pripravci na bazi žita; prehrambene pločice na bazi žitarica; prehrambene pločice na bazi čokolade [gotove za potrošnju]; prehrambeni proizvodi na bazi šećera za zaslađivanje deserta; prehrambeni proizvodi na bazi zaslađivača za zaslađivanje deserta; prehrambeni proizvodi na bazi zaslađivača za pravljenje deserta; premaz s okusom čokolade; prerađene žitarice, škrobovi i njihovi proizvodi, pripravci za pečenje i kvasci; princes krafne; pripravci na bazi žitarica za poboljšanje kruha; pripravci na bazi kaka; pripravci od žitarica; pripravci od žitarica prekriveni šećerom i medom; pripravci na prahu koji sadržavaju kaka za pripremu napitaka; pripravci za čokoladna pića s okusom banane; pripravci za čokoladna pića s okusom karamela; pripravci za čokoladna pića; pripravci za čokoladna pića s okusom metvice; pripravci za čokoladna pića s okusom orašiča; pripravci za čokoladna pića s okusom naranče; pripravci za čokoladna pića s okusom moke; pripravci za izradu slatkiša; pripravci za pića s okusom čokolade; pripravci za pravljenje umaka; pripravci za pripremu napitaka [na bazi kaka]; pripravci za pripremu napitaka [na bazi kave]; pripravci za pripremu napitka [na bazi čaja]; pripravci za pripremu napitaka [na bazi čokolade]; pripravci za pripremu pekarskih proizvoda; pripravci za pripremu torti (gateaux); pripravci za pripremu vafli; pripravci za pripremu umaka koji se sastoje od zobenih mekinja; pripravci žitarica koji se sastoje od mekinja; pripravci žitarica koji sadržavaju zobene mekinje; prirodne rižine pahuljice; proizvodi na bazi čokolade; šećerna vuna; šećerni bomboni (nemedicinski -); šećerni bomboni [za prehranu]; šećerni konditorski proizvodi (nemedicinski -); šećerni štapići; sirup za palačinke; sirup za preljev; škotski kolačići s preljevom okusa čokolade; škotski kolačići s čokoladnim preljevom; škotski kolačići napola prekriveni čokoladom; škotski kolačići s preljevom s čokoladnom aromom; škotske slastice [u obliku tablica]; škotski kolačići djelomično prekriveni preljevom s aromom čokolade; sladoled; sladoled bez mlijeka; sladoled na bazi jogurta [sladoled prevladava]; sladoled natopljen alkoholom; sladoled s tartufima; sladoled s voćem; sladoled (vezivna sredstva za -); sladoledi; sladoledi koje sadrže mlijeko; sladoledi koji sadrže čokoladu; sladoledi na bazi soje; slane grickalice na bazi brašna; sladoledi s aromom mlijeka; sladoledi s okusom čokolade; sladoledi, smrznuti jogurti i sorbeti; sladoledni deserti; sladoledni sendviči; slane arome za hranu [osim esencijalnih ulja]; slastice [bomboni]; slastičarske kapljice za pečenje; slastice od tijesta koje sadrže kreme i voće; slastice od tijesta koje sadrže voće; slastice od tijesta koje sadrže kreme; slastice od tijesta s voćem; slastice od zamrznutog jogurta; slastice s niskim udjelom ugljikohidrata; slastice, torte, pite i keksi; slatke glazure; slatke glazure i punjenja; slatke kokice; slatke pločice; slatki keksi za ljudsku konzumaciju; slatki namazi [med]; slatkiši; slatkiši bez šećera; slatkiši [bombon] aromatizirani voćem; slatkiši [bomboni]; slatkiši [bombon] koji sadrže voće; slatkiši (bomboni), čokoladice i guma za žvakanje; slatkiši (nemedicinski -); slatkiši na bazi metvice [nemedicinski]; slatkiši (nemedicinski -) - čokoladni ekleri; slatkiši (nemedicinski -) koji sadrže biljne arome; slatkiši (nemedicinski -) na bazi meda; slatkiši (nemedicinski -) - nugat; slatkiši (nemedicinski -) na bazi alkohola; slatkiši (nemedicinski -) - šećerni konditorski proizvodi; slatkiši (nemedicinski -) u komprimiranom obliku; slatkiši (nemedicinski -) u obliku bombona; slatkiši s čokoladnim preljevom; slatkiši s okusom metvice (nemedicinski -); slatkiši sa kuhanim šećerom; slatkiši s preljevom (nemedicinski -); slatkiši za dekoraciju kolača; slatkiši za ukrašavanje kolača; smjesa za palačinke; smrznute palačinke; smrznuti mliječni desert u obliku pločice; smrznuti vafli; smrznuto tijesto za biscotti kekse; smrznuto tijesto za čokoladne kolače [brownies]; štapići od sladića [slatkiši]; štapići cimeta; štapići vanilije; staklasta glazura [staklasti preljev]; tekući konditorski proizvodi; tijesto za keks; tijesto za

kekse biscotti; tijesto za brownije; tijesto za palačinke; topli čokolada; tople žitarice za doručak; torta od badema; torta sa slatkima; torte; torte od jagoda; torte od sira; torte od sladoleda; torte s glazurom; tradicionalni korejski komprimirani slatkiši [dasik]; tradicionalne engleske pite sa šećernim sirupom i mrvicama; tradicionalne britanske božićne pite od voća; trajna peciva; turski rahat lokum; turski rahat lokum preliven čokoladom; tvrde karamele prelivene šećerom; tvrdi bomboni; tvrde karamele [bomboni]; umaci za sladoled; umak od brusnica [kondiment]; umak od jabuka [kondiment]; ušećerani bademi; ušećerani pinjoli; vafli s čokoladnim preljevom; vanilija; veganska vruća čokolada; veganski kolači; veganski sladoled; visoka čokoladna torta sa čokoladnim spužvastim biskvitom; voće s preljevom od čokolade; voćne arome, osim esencija; voćne arome, osim esencijalnih ulja; voćni bomboni [konditorski proizvod]; voćni gumeni bomboni [za nemedicinsku uporabu]; voćni jestivi sladoledi; voćni kolači; voćni kolači s glazurom; voćni kolačići; voćni šećer; voćni sladoled; voćni sladoledi; voda narančinog cvijeta za kulinarske potrebe; vodeni sladoledi na štapiću s voćnom aromom; vodeni sladoled; vruća čokolada; začinjene palačinke; zamjene za čokoladu; zamjena za sladoled; zamjene za kakao; zamrznuti kolači; zamrznuta peciva; zamrznuta krema od vanilije; zamrznuti konditorski proizvodi koji sadržavaju sladoled; zamrznuti konditorski proizvodi; zamrznuti konditorski proizvodi na štapiću; zamrznuti mliječni konditorski proizvodi; zaslađivači koji se sastoje od voćnih koncentrata; zamrznuto tijesto za keks; zefir [slastice]; zatvorena pita od prhkog tijesta; zaslađivači (prirodni -) u granulama; žele bomboni (jelly beans); žitarice; žitarice, kaša i krupice za doručak; žitarice pripremljene za konzumaciju ljudi; žitarice spremne za jelo; žitarice u prahu; žitarice za doručak; žitarice za doručak koje sadrže mješavinu voća i vlakana; žitarice za doručak koje sadrže med; žitarice za doručak koje sadrže vlakna; žitarice za doručak koje sadrže voće; žitarice za doručak od riže; žitarice za doručak s okusom meda; žitarice za prehranu ljudi; žitne pločice; zob za kašu; zobena kaša; zobena kaša za ljudsku konzumaciju; zobene i pšenične pahuljice; zobene pahuljice; zobene pločice; zobeni keksi za ljudsku konzumaciju; zobeni kolači za ljudsku konzumaciju; žvakaće gume za osvježavanje daha; žvakaće gume [nisu za medicinske potrebe]; žvakaće gume; žvakaća guma zdrava za zube [nemedicinska]; žvakaća guma bez šećera

(591) narančasta, bijela, bordo  
(531) 27.05.01; 27.05.02; 27.05.09; 29.01.01; 29.01.06  
(511) 32 aromatizirane vode; bezalkoholna pića; bezalkoholna pića koja sadrže voćne sokove; bezalkoholna pića s okusom čaja; bezalkoholna pića s okusom voća; bezalkoholna voćna pića; bezalkoholni napitci obogaćeni vitaminima; bezalkoholni napitci od suhog voća; energetska pića [za nemedicinsku upotrebu]; energetske napitci; frapei [bezalkoholni voćni napitci]; funkcionalna pića na bazi vode; gazirana bezalkoholna pića; gazirana voda obogaćena vitaminima [napitci]; gazirana voda [soda-voda]; izotonična pića; izotonični napitci; izotonični napitci [za nemedicinsku upotrebu]; koncentracije za pripremu bezalkoholnih pića; mineralne i gazirane vode; mineralne vode [piće]; mineralne vode s okusima; mješavine za pripremu bezalkoholnih napitaka; napici na bazi voća; napici s okusom voća; napitci obogaćeni nutrijentima; napitci s vitaminima; negazirana bezalkoholna pića; niskokalorična bezalkoholna pića; pića na bazi vode koja sadrže čajne ekstrakte; prašci koji se koriste u pripremi pića na bazi voća; pripravci za pripremu pića; proteinska pića; sirupi i ostali bezalkoholni pripravci za pripremanje napitaka; soda-voda; sokovi; sportski napitci; stolne vode; tonik [nemedicinski napitci]; ugljikohidratna pića; voćna pića; voćni napitci; voda; voda obogaćena mineralima [napitci]; voda obogaćena nutrijentima; voda s okusom voća; voda, Seltz; voda za piće; voda za piće s vitaminima; vode s okusima

(210)	Z20240131A	(220)	14.02.2024.
		(442)	15.03.2024.
(731)	<b>ATLANTIC CEDEVITA d.o.o.</b>		
(540)	Planinska 15, 10000 Zagreb, HR		



(591) narančasta, bijela, bordo  
(531) 27.05.01; 27.05.02; 27.05.09; 29.01.01; 29.01.06  
(511) 32 aromatizirane vode; bezalkoholna pića; bezalkoholna pića koja sadrže voćne sokove; bezalkoholna pića s okusom čaja; bezalkoholna pića s okusom voća; bezalkoholna voćna pića; bezalkoholni napitci obogaćeni vitaminima; bezalkoholni napitci od suhog voća; energetska pića [za nemedicinsku upotrebu]; energetske napitci; frapei [bezalkoholni voćni napitci]; funkcionalna pića na bazi vode; gazirana bezalkoholna pića; gazirana voda obogaćena vitaminima [napitci]; gazirana voda [soda-voda]; izotonična pića; izotonični napitci; izotonični napitci [za nemedicinsku upotrebu]; koncentracije za pripremu bezalkoholnih pića; mineralne i gazirane vode; mineralne vode [piće]; mineralne vode s okusima; mješavine za pripremu bezalkoholnih napitaka; napici na bazi voća; napici s okusom voća; napitci obogaćeni nutrijentima; napitci s vitaminima; negazirana bezalkoholna pića; niskokalorična bezalkoholna pića; pića na bazi vode koja sadrže čajne ekstrakte; prašci koji se koriste u pripremi pića na bazi voća; pripravci za pripremu pića; proteinska pića; sirupi i ostali bezalkoholni pripravci za pripremanje napitaka; soda-voda; sokovi; sportski napitci; stolne vode; tonik [nemedicinski napitci]; ugljikohidratna pića; voćna pića; voćni napitci; voda; voda obogaćena mineralima [napitci]; voda obogaćena nutrijentima; voda s okusom voća; voda, Seltz; voda za piće; voda za piće s vitaminima; vode s okusima

(210)	Z20240063A	(220)	23.01.2024.
		(442)	15.03.2024.
(731)	<b>Kandit d.o.o.</b>		
(540)	Vukovarska cesta 239, 31000 Osijek, HR		

## ZEKO JE REKO

(511) 30 čokolada; čokolada u obliku pralina; bomboni; čokoladni bomboni; tvrdi bomboni; bomboni [slatkiši]; čokoladni musevi [pjenice]; praline s tekućim punjenjem; kakao u prahu

### RAZRED 32

(210)	Z20240130A	(220)	14.02.2024.
		(442)	15.03.2024.
(731)	<b>ATLANTIC CEDEVITA d.o.o.</b>		
(540)	Planinska 15, 10000 Zagreb, HR		



### RAZRED 34

(210)	Z20240003A	(220)	03.01.2024.
		(442)	15.03.2024.
(731)	<b>TDR d.o.o.</b>		
(740)	Obala V. Nazora 1, 52210 Rovinj (Rovigno), HR ZMP IP d.o.o., Zagreb, HR		

(540)

**RONHILL**

(511) **34** filter cigarete; duhan; pribor za pušače; šibice  
**35** oglašavanje i reklamiranje; vođenje komercijalnih poslova; komercijalna administracija; uredski poslovi

**RAZRED 35**

(210) Z20240030A (220) 10.01.2024.  
(442) 15.03.2024.  
(731) **Trgovina Krk d.d.**  
(540) Dubašljanska 80, 51511 Malinska, HR

**IN'S** shop

(591) tirkizna, tamnosiva  
(531) 27.05.01; 27.05.09; 29.01.04; 29.01.06  
(511) **35** maloprodajne usluge povezane s dodatnom opremom za automobile; maloprodajne usluge u vezi s čokoladom; maloprodajne usluge u vezi s duhanom; maloprodajne usluge u vezi s hranom; maloprodajne usluge u vezi s gorivom; maloprodajne usluge u vezi s igračkama; maloprodajne usluge u vezi s kavom; maloprodajne usluge u vezi s pivom; maloprodajne usluge u vezi s sladoledima; maloprodajne usluge u vezi sa slatkišima; maloprodajne usluge vezane uz artikle za čišćenje; maloprodajne usluge vezane uz artikle za uporabu s duhanom; maloprodajne usluge vezane uz toaletne proizvode; maloprodajne usluge vezane za alkoholna pića (osim piva); maloprodajne usluge vezane za bezalkoholna pića; maloprodajne usluge vezane za pekarske proizvode  
**37** benzinske postaje za vozila [točenje goriva i održavanje]  
**39** skladištenje plina  
**43** usluge hrane i pića za ponijeti

(210) Z20240031A (220) 10.01.2024.  
(442) 15.03.2024.  
(731) **Trgovina Krk d.d.**  
(540) Dubašljanska 80, 51511 Malinska, HR

**IN'S** drive

(591) tirkizna, tamnosiva  
(531) 27.05.01; 27.05.09; 29.01.04; 29.01.06  
(511) **35** maloprodajne usluge povezane s dodatnom opremom za automobile; maloprodajne usluge u vezi s čokoladom; maloprodajne usluge u vezi s duhanom; maloprodajne usluge u vezi s hranom; maloprodajne usluge u vezi s gorivom; maloprodajne usluge u vezi s igračkama; maloprodajne usluge u vezi s kavom; maloprodajne usluge u vezi s pivom; maloprodajne usluge u vezi s sladoledima; maloprodajne usluge u vezi sa slatkišima; maloprodajne usluge vezane uz artikle za čišćenje; maloprodajne usluge vezane uz artikle za uporabu s duhanom; maloprodajne usluge vezane uz tiskani materijal; maloprodajne usluge vezane uz toaletne proizvode; maloprodajne usluge vezane za alkoholna pića (osim piva); maloprodajne usluge vezane za bezalkoholna pića; maloprodajne usluge vezane za pekarske proizvode  
**37** benzinske postaje za vozila [točenje goriva i održavanje]  
**39** skladištenje plina  
**43** usluge hrane i pića za ponijeti

(210) Z20240032A (220) 10.01.2024.  
(442) 15.03.2024.  
(731) **Trgovina Krk d.d.**  
(540) Dubašljanska 80, 51511 Malinska, HR



(591) tirkizna, tamnosiva  
(531) 01.15.15; 01.15.21; 20.01.17; 24.17.24; 24.15.01; 24.15.13; 26.01.05; 27.05.01; 29.01.04; 29.01.06  
(511) **35** maloprodajne usluge povezane s dodatnom opremom za automobile; maloprodajne usluge u vezi s čokoladom; maloprodajne usluge u vezi s duhanom; maloprodajne usluge u vezi s hranom; maloprodajne usluge u vezi s gorivom; maloprodajne usluge u vezi s igračkama; maloprodajne usluge u vezi s kavom; maloprodajne usluge u vezi s pivom; maloprodajne usluge u vezi s sladoledima; maloprodajne usluge u vezi sa slatkišima; maloprodajne usluge vezane uz artikle za čišćenje; maloprodajne usluge vezane uz artikle za uporabu s duhanom; maloprodajne usluge vezane uz tiskani materijal; maloprodajne usluge vezane uz toaletne proizvode; maloprodajne usluge vezane za alkoholna pića (osim piva); maloprodajne usluge vezane za bezalkoholna pića; maloprodajne usluge vezane za pekarske proizvode  
**37** benzinske postaje za vozila [točenje goriva i održavanje]  
**39** skladištenje plina  
**43** usluge hrane i pića za ponijeti

(210) Z20240035A (220) 12.01.2024.  
(442) 15.03.2024.  
(731) **TECTUS d.o.o.**  
Lastovska ulica 40, 10000 Zagreb, HR  
**Nikola Milijević**  
(540) Lastovska ulica 40, 10000 Zagreb, HR

**CROPAK**

(591) crna, bijela  
(531) 19.03.03; 19.03.24; 27.05.01; 27.05.05; 27.07.01  
(511) **35** usluge oglašavanja, marketinga i promidžbe  
**39** ambalažiranje i usluge pakiranja  
**41** dodjela [organiziranje] nagrada  
**42** savjetovanje u svezi s dizajnom ambalaža

(210) Z20240036A (220) 12.01.2024.  
(442) 15.03.2024.  
(731) **TECTUS d.o.o.**  
Lastovska ulica 40, 10000 Zagreb, HR  
**Nikola Milijević**  
(540) Lastovska ulica 40, 10000 Zagreb, HR

**REGPAK**

(511) **35** usluge oglašavanja, marketinga i promidžbe  
**39** pakiranje i skladištenje robe  
**41** dodjela [organiziranje] nagrada  
**42** ambalaža (usluge crtača ambalaže)

(210)	Z20240039A	(220)	15.01.2024.
		(442)	15.03.2024.
(731)	<b>UDRUGA JEDINSTVENIH HRVATSKIH HOTELA STORIES</b>		
(540)	Ilica 15, 10000 Zagreb, HR		

## IMPRESIA

(511)	<b>35</b> usluge oglašavanja u svezi s hotelima; pružanje informacija o usporedbi hotelskih cijena; savjetodavne poslovne usluge; savjetodavanje za upravljanje; organiziranje i provođenje sajmova
	<b>43</b> rezervacija hotela; informacije o hotelima; ponuda hotelskog smještaja; procjena hotelskog smještaja; pružanje informacija u svezi s hotelima; pružanje informacija o hotelima putem mrežne stranice

(210)	Z20240067A	(220)	24.01.2024.
		(442)	15.03.2024.
(731)	<b>Ivan Raguž</b>		
(740)	Velimira Kljaića 2, 10000 Zagreb, HR		
(540)	Natalija Labavić, Zagreb, HR		

## RHINNOVA

(511)	<b>35</b> usluge maloprodaje ili veleprodaje za farmaceutske i medicinske potrepštine; usluge maloprodaje ili veleprodaje medicinskih zaštitnih maski za kosti lica
	<b>41</b> usluge medicinske poduke; vođenje obrazovnih seminara u svezi s medicinskim pitanjima; organizacija seminara i konvencija na području medicine; pružanje medicinskih tečajeva; usluge medicinskog obrazovanja
	<b>44</b> estetska kirurgija; kliničke usluge plastične i kozmetičke kirurgije; plastična kirurgija; rekonstruktivna kirurgija; otorinolaringologija; kirurgija; savjetodavne i konzultantske usluge iz područja estetske i plastične kirurgije

## RAZRED 36

(210)	Z20231133A	(220)	22.11.2023.
		(442)	15.03.2024.
(731)	<b>Stipe Plejić</b>		
(740)	Ulica Marka Marulića 7, 21210 Solin, HR		
(540)	Ivan Čizmić, Split, HR		

## STONEBLOCK

(511)	<b>36</b> financijske transakcije primjenom tehnologije lanac blokova
	<b>42</b> lanac podatkovnih blokova kao usluga [BaaS]

(210)	Z20231134A	(220)	22.11.2023.
		(442)	15.03.2024.
(731)	<b>Stipe Plejić</b>		
(740)	Ulica Marka Marulića 7, 21210 Solin, HR		
(540)	Ivan Čizmić, Split, HR		

## ENDEMIC

(511)	<b>36</b> financijske transakcije primjenom tehnologije lanac blokova
	<b>42</b> lanac podatkovnih blokova kao usluga [BaaS]

(210)	Z20231136A	(220)	22.11.2023.
		(442)	15.03.2024.
(731)	<b>Stipe Plejić</b>		
(740)	Ulica Marka Marulića 7, 21210 Solin, HR		
(540)	Ivan Čizmić, Split, HR		



(591)	crna, bijela, crvena, zelena, narančasta, siva, bordo
(531)	07.05.06; 10.05.13; 27.05.05; 27.05.04; 29.01.15
(511)	<b>36</b> financijske transakcije primjenom tehnologije lanac blokova
	<b>42</b> lanac podatkovnih blokova kao usluga [BaaS]

(210)	Z20231137A	(220)	22.11.2023.
		(442)	15.03.2024.
(731)	<b>Stipe Plejić</b>		
(740)	Ulica Marka Marulića 7, 21210 Solin, HR		
(540)	Ivan Čizmić, Split, HR		



(591)	crna, bijela, plava, svijetlo plava
(531)	07.05.11; 26.11.03; 26.11.06; 26.11.09; 26.11.11; 27.05.01; 27.05.10; 27.05.24
(511)	<b>36</b> financijske transakcije primjenom tehnologije lanac blokova
	<b>42</b> lanac podatkovnih blokova kao usluga [BaaS]

(210)	Z20231139A	(220)	22.11.2023.
		(442)	15.03.2024.
(731)	<b>Stipe Plejić</b>		
(740)	Ulica Marka Marulića 7, 21210 Solin, HR		
(540)	Ivan Čizmić, Split, HR		



(591)	crna, bijela, plava, svijetlo zelena
(531)	26.01.02; 26.01.05; 27.05.01; 27.05.10; 27.05.24
(511)	<b>36</b> financijske transakcije primjenom tehnologije lanac blokova
	<b>42</b> lanac podatkovnih blokova kao usluga [BaaS]

(210)	Z20231140A	(220)	22.11.2023.
		(442)	15.03.2024.
(731)	<b>Stipe Plejić</b>		
(740)	Ulica Marka Marulića 7, 21210 Solin, HR		
(540)	Ivan Čizmić, Split, HR		





- (591) crna, bijela, plava, svijetlo zelena  
 (531) 07.05.11; 26.11.03; 26.11.09; 26.11.11  
 (511) **36** financijske transakcije primjenom tehnologije lanac blokova  
**42** lanac podatkovnih blokova kao usluga [BaaS]

- (210) Z20240128A (220) 03.10.2023.  
 (442) 15.03.2024.  
 (731) **Nova Investment Management Limited**  
 33 Sir John Rogerson's Quay, D02 XK09 Dublin 2, IE  
 (740) ZMP IP d.o.o., Zagreb, HR  
 (540)



- (591) crvena, bijela, crna  
 (531) 26.01.03; 26.01.18; 27.05.21; 29.01.01  
 (641) 018932813, 03.10.2023.  
 (511) **36** Usluge poslovnih investicija; upravljanje ulaganjem; upravljanje ulagačkim fondovima; upravljanje ulaganjima u portfelje; trgovanje financijskim instrumentima; brokerske usluge u svezi s financijskim instrumentima; financijske usluge; savjetovanje o financijskim pitanjima; financijske posredničke usluge; pružanje informacija u području financijskih usluga; savjetodavne usluge povezane s financijskim investicijama; informacije u svezi s ulaganjima.

## RAZRED 41

- (210) Z20231128A (220) 22.11.2023.  
 (442) 15.03.2024.  
 (731) **Nataša Radas**  
 Bana Berislavića 9, 21000 Split, HR  
 (740) Ivan Čizmić, Split, HR  
 (540)



- (591) plava, žuta, bijela, crvena, narančasta  
 (531) 26.04.01; 26.04.08; 27.05.01; 27.05.02; 27.05.09; 27.05.10;  
 27.05.13; 29.01.01; 29.01.02; 29.01.04  
 (511) **41** akademske usluge (Obrazovne -); filmska produkcija u obrazovne svrhe; informacije (Obrazovne -); izložbene usluge u obrazovne svrhe; izložbi (Organiziranje -) u obrazovne svrhe; izložbi (Organiziranje -) u kulturne ili obrazovne svrhe; izložbi (Vođenje -) u obrazovne svrhe; obrazovne demonstracije; obrazovne informacije; obrazovne informativne usluge; obrazovne Online informacije omogućene putem računalne baze podataka ili putem interneta; obrazovne savjetodavne usluge; obrazovne usluge dopisnih škola; obrazovne usluge koje pružaju ustanove za dodatno obrazovanje; obrazovne usluge koje pružaju škole; obrazovne usluge koje pružaju sveučilišta; obrazovne usluge koje pružaju fakulteti; obrazovne usluge koje pružaju srednje škole; obrazovne usluge koje pružaju asistenti u nastavi; obrazovne usluge putem radija; obrazovne usluge putem televizije; obrazovne usluge putem televizijskih programa; obrazovne usluge s podukom u

svezi s oporezivanjem imovine; obrazovne usluge srednje škole; obrazovne usluge u obliku dopisnih tečajeva; obrazovne usluge u obliku tečajeva na sveučilišnoj razini; obrazovne usluge u obliku personaliziranog obrazovanja; obrazovne usluge u području medicine; obrazovne usluge u svezi s upotrebom računala u poslovanju; obrazovne usluge u svezi s razvojem dječjih mentalnih sposobnosti; obrazovne usluge u svezi s primjenom računalnih sustava; obrazovne usluge u svezi sa stenografskim sustavima bilježenja; obrazovne usluge u svezi s tjelesnom spremnosti; obrazovne usluge u svezi s upravljanjem; obrazovne usluge u svezi s modeliranjem; obrazovne usluge u svezi sa zdravljem; obrazovne usluge u svezi s medicinom; obrazovne usluge u svezi s podučavanjem drugog jezika; obrazovne usluge u svezi s poslovnom obukom; obrazovne usluge u svezi s računalnim sustavima; obrazovne usluge u svezi s komunikacijskim vještinama; obrazovne usluge u svezi s umjetnosti; obrazovne usluge u svezi sa stručnim osposobljavanjem; obrazovne usluge u svezi s fotografskim tiskanjem; obrazovne usluge u svezi s dizajnom; obrazovne usluge u svezi s razvojem dječjih intelektualnih sposobnosti; obrazovne usluge u svezi s podučavanjem stranih jezika; obrazovne usluge u svezi s kvalitetom usluga; obrazovne usluge u svezi s fotografijom; obrazovne usluge u svezi s duhovnim razvojem; obrazovne usluge u svezi s upravljanjem poslovnom franšizom; obrazovne usluge u svezi s jezicima; obrazovne usluge u svezi s obradom podataka; obrazovne usluge u svezi s računalima; obrazovne usluge u svezi sa sportom; obrazovne usluge u svezi s kinom; obrazovne usluge u svezi s terapijskim tretmanima; obrazovne usluge u svezi s primjenom računalnog softvera; obrazovne usluge u svezi s informacijskom tehnologijom; obrazovne usluge u svezi s pisanjem računalnih programa; obrazovne usluge u svezi s poslovanjem; obrazovne usluge u svezi s kvantnim računalstvom; obrazovne usluge u zdravstvenom sektoru; obrazovne usluge ustanova visoke naobrazbe; obrazovne usluge za dječje učitelje; obrazovne usluge za djecu; obrazovne usluge za dramsku umjetnost; obrazovne usluge za industriju; obrazovne usluge za podučavanje pisanja pomoću tipkovnice; obrazovne usluge za podučavanje tehnika transkripcije; obrazovne usluge za podučavanje metoda podučavanja jezika; obrazovne usluge za podučavanje glume; obrazovne usluge za podučavanje jezika; obrazovne usluge za podučavanje ručnog pisanja; obrazovne usluge za podučavanje metoda obrađivanja podataka; obrazovne usluge za ponudu tečajeva za poduku; obrazovne usluge za ponudu obrazovnih tečajeva; obrazovne usluge za upravljačko osoblje; obrazovne, zabavne i sportske usluge; Online testiranje u obrazovne svrhe; organizacija i održavanje sajмова u kulturne ili obrazovne svrhe; organizacija izložbi u kulturne ili obrazovne svrhe; organizacija kongresa i konferencija za kulturne i obrazovne svrhe; organiziranje demonstracija u obrazovne svrhe; organiziranje festivala u obrazovne svrhe; organiziranje godišnje obrazovne konferencije; organiziranje i održavanje izložbi za obrazovne potrebe; organiziranje i održavanje predavanja za obrazovne potrebe; organiziranje izložaba u kulturne i obrazovne svrhe; organiziranje izložbi u kulturne i obrazovne svrhe; organiziranje izložbi u kulturne ili obrazovne svrhe; organiziranje izložbi u obrazovne svrhe; organiziranje konferencija u obrazovne svrhe; organiziranje konvencija u obrazovne svrhe; organiziranje natjecanja u obrazovne svrhe; organiziranje prezentacija u obrazovne svrhe; organiziranje prikaza u obrazovne svrhe; organiziranje priredbi u obrazovne svrhe; organiziranje seminara u obrazovne svrhe; planiranje konferencija u obrazovne svrhe; planiranje predavanja u obrazovne svrhe; planiranje seminara u obrazovne svrhe; prikazivanja filmova u odgojno-obrazovne svrhe; pripremanje izložbi u obrazovne svrhe; produkcija filmova u obrazovne svrhe; pružanje objekata i sredstava u obrazovne svrhe; pružanje prostorija za obrazovne provjere znanja; računalne obrazovne usluge u području poslovnog upravljanja; radijske usluge za pružanje obrazovne revizije; radionice u obrazovne svrhe; razgovor s poznatim suvremenicima u obrazovne svrhe; školske obrazovne usluge; svečanosti (Organiziranje -) u obrazovne svrhe; testiranje u obrazovne svrhe; usluge audiovizualnih prezentacija u obrazovne svrhe; usluge ispitivanja u obrazovne svrhe; usluge obrazovne akademije; usluge provjere znanja (Obrazovne -); usluge ustanova za

- brigu o djeci [obrazovne]; usluge vrtića [obrazovne]; vođenje izložbi u obrazovne svrhe; vođenje razgledavanja kulturnih mjesta uz pratnju vodiča, (u obrazovne svrhe); akreditacija [certifikacija] obrazovnih postignuća; akreditacija obrazovnih usluga; analiza rezultata i podataka iz obrazovnih ispita za druge; dogovaranje i vođenje obrazovnih događaja; izdavanje obrazovnih knjiga; iznajmljivanje obrazovnih materijala; izvođenje obrazovnih događanja; natjecanja (Organiziranje obrazovnih -); objavljivanje obrazovnih tekstova; obrazovne usluge za ponudu obrazovnih tečajeva; obrazovnih institucija (Usluge -); obrazovnih materijala ili uređaja (Iznajmljivanje -); organizacija i izvođenje natjecanja [obrazovnih ili zabavnih]; organizacija i izvođenje obrazovnih raspravnih skupina [nije Online]; organizacija obrazovnih aktivnosti za ljetne kampove; organizacija obrazovnih događanja; organizacija vođenih obrazovnih obilazaka; organiziranje i provođenje osobnih obrazovnih foruma; organiziranje ispita [obrazovnih]; organiziranje obrazovnih igara; organiziranje obrazovnih izložbi; organiziranje obrazovnih kongresa; organiziranje obrazovnih natjecanja; organiziranje obrazovnih seminara; organiziranje obrazovnih predavanja; organiziranje obrazovnih simpozija; organiziranje obrazovnih konvencija; organiziranje obrazovnih konferencija; organiziranje trajnih obrazovnih seminara; ponuda obrazovnih demonstracija; postavljanje obrazovnih standarda; priprema i održavanje obrazovnih sajмова; priprema obrazovnih tečajeva i ispita; priprema vođenih obrazovnih obilazaka; pripremanje obrazovnih programa; produkcija obrazovnih televizijskih programa; produkcija obrazovnih zvučnih i video snimaka; produkcija televizijskih obrazovnih programa uživo; provođenje obrazovnih programa potpore za zdravstvene radnike; pružanje dječjih obrazovnih usluga kroz grupe za igranje; pružanje obrazovnih informacija; pružanje obrazovnih informacija u vezi sa zdravljen i fitnessom; pružanje obrazovnih ispita i testova; pružanje obrazovnih tečajeva u svezi sa telekomunikacijama; pružanje obrazovnih tečajeva; pružanje obrazovnih tečajeva u vezi sa računalima; pružanje obrazovnih tečajeva u svezi sa elektronikom; pružanje obrazovnih tečajeva o prehrani; pružanje obrazovnih usluga u svezi sa ekološkim temama; pružanje obrazovnih usluga u svezi sa zdravljenom; pružanje obrazovnih usluga u svezi sa tjelesnom spremom; pružanje usluga obrazovnih ispita; pružanje usluga obrazovnih tečajeva; pružanje usluga obrazovnih tečajeva za mlade; pružanje usluga računalno potpomognutih obrazovnih tečajeva; razvoj obrazovnih materijala; razvoj obrazovnih priručnika; uslugama obrazovnih ispita (Informacije u svezi s -); usluge obrazovnih akademija za podučavanje jezika; usluge obrazovnih ustanova; usluge obrazovnih ustanova koje pružaju tečajeve za poduku; usluge organiziranja obrazovnih programa; usluge pružanja obrazovnih informacija; vođenje obrazovnih konferencija; vođenje obrazovnih obilazaka s vodičem; vođenje obrazovnih seminara u svezi s medicinskim pitanjima; vođenje obrazovnih seminara u svezi s upravljanjem vremenom; vođenje obrazovnih seminara u svezi s organizacijom vremena; vođenje obrazovnih seminara; vođenje obrazovnih tečajeva u svezi sa znanostima; vođenje obrazovnih tečajeva za poslovno upravljanje; vođenje obrazovnih tečajeva; vođenje obrazovnih tečajeva u svezi s poslovnim upravljanjem; vođenje obrazovnih tečajeva za poslovanje; vođenje obrazovnih tečajeva u svezi s poslovanjem; vođenje obrazovnih tečajeva, tečajeva obuke i osposobljavanja za mlade i odrasle; individualno vježbanje (obuka); obuka; obuka osoba; obuka u području medicine; obuka za računalno potpomognuti dizajn (CAD); obuka za zaposlenje; obuka za zapošljavanje; poslovna obuka kroz igru; poslovna obuka kroz simulaciju; predškolska obuka; radionice (organiziranje i vođenje -) [obuka]
- 42 ažuriranje i dizajn računalnog softvera; dizajn 3D modela za 3D ispis; dizajn ambalaže; dizajn ambalaže za druge; dizajn, ažuriranje i održavanje računalnog softvera; dizajn brošura; dizajn CD-ROM elektroničkog formata za računalne baze podataka; dizajn grafičke ilustracije; dizajn grafičkih softverskih sustava; dizajn grafike i znakovlja u svrhu korporativnog identiteta; dizajn hardvera; dizajn i ažuriranje početnih i internetskih stranica; dizajn i ažuriranje računalnog softvera; dizajn i grafički dizajn za izradu web-stranica na internetu; dizajn i grafički dizajn za izradu internetskih stranica; dizajn i izrada internetskih stranica za druge; dizajn i izrada početnih i internetskih stranica; dizajn i izrada početnih stranica i internetskih stranica; dizajn i izrada početnih stranica i web-stranica; dizajn i kreiranje internetskih stranica za druge; dizajn i održavanje internetskih stranica za druge; dizajn i održavanje računalnih stranica za treću stranu; dizajn i pisanje računalnog softvera; dizajn i razrada informatičkih sustava; dizajn i razvoj arhitekture računalnog hardvera; dizajn i razvoj arhitekture računalnog softvera; dizajn i razvoj baza podataka; dizajn i razvoj dijagnostičkih uređaja; dizajn i razvoj elektroničkih sustava za zaštitu podataka; dizajn i razvoj industrijskih proizvoda; dizajn i razvoj metoda za ispitivanje i analizu; dizajn i razvoj nove tehnologije za druge; dizajn i razvoj operativnog softvera za pristup i korištenje mreža računarstva u oblaku; dizajn i razvoj operativnog softvera za računalne mreže i servere; dizajn i razvoj početnih i internetskih stranica; dizajn i razvoj potrošačkih proizvoda; dizajn i razvoj programa za internetsku sigurnost; dizajn i razvoj programa za elektroničke baze podataka; dizajn i razvoj programa za obradu podataka; dizajn i razvoj programa za računalne baze podataka; dizajn i razvoj proizvoda; dizajn i razvoj računalnih programa za kontrolu procesa; dizajn i razvoj računalnih programa za obradu teksta; dizajn i razvoj računalnih programa za portale logistike, upravljanja opskrbnim lancem i e-trgovine; dizajn i razvoj računalnih programa za evaluaciju i izračun podataka; dizajn i razvoj računalnih programa za čitanje, prijenos i organizaciju podataka; dizajn i razvoj računalnih programa za obradu slika; dizajn i razvoj računalnih ugrađenih programa; dizajn i razvoj računalnog softvera; dizajn i razvoj računalnog softvera za upravljanje bazama podataka; dizajn i razvoj računalnog hardvera za proizvođačku industriju; dizajn i razvoj softvera; dizajn i razvoj softvera za uvoz i upravljanje podacima; dizajn i razvoj softvera za razvoj internetskih stranica; dizajn i razvoj softvera za upravljanje energijom; dizajn i razvoj softvera za upravljanje inventarom; dizajn i razvoj softvera za planiranje ruta; dizajn i razvoj softvera za računalne igre; dizajn i razvoj softvera za virtualnu stvarnost; dizajn i razvoj softvera za računalne igre i softvera za virtualnu stvarnost; dizajn i razvoj softvera za računalne baze podataka; dizajn i razvoj softvera operativnog sustava; dizajn i razvoj softvera za pronalaženje podataka; dizajn i razvoj sustava za proizvodnju regenerativne energije; dizajn i razvoj sustava za obradu podataka; dizajn i razvoj sustava za prikaz podataka; dizajn i razvoj sustava za pohranu podataka; dizajn i razvoj sustava za unos, iznos, obradu, prikazivanje i pohranu podataka; dizajn i razvoj sustava za unos podataka; dizajn i razvoj sustava za izlaz podataka; dizajn i razvoj telekomunikacijskih mreža; dizajn i razvoj upravljačkih programa; dizajn i razvoj uređaja za bežični prijenos podataka; dizajn i razvoj uređaja za obradu podataka; dizajn i testiranje novih proizvoda; dizajn i testiranje razvoja novog proizvoda; dizajn igara na ploči; dizajn igračkа; dizajn (Industrijski -); dizajn industrijskih proizvoda; dizajn internetskih mjesta; dizajn internetskih početnih stranica; dizajn internetskih stranica; dizajn kalupa; dizajn matematičkih modela; dizajn modela; dizajn, održavanje i ažuriranje računalnog softvera; dizajn, održavanje, iznajmljivanje i ažuriranje računalnog softvera; dizajn, održavanje, razvoj i ažuriranje računalnog softvera; dizajn online softvera za društvene mreže; dizajn početne stranice i Internetske stranice; dizajn početnih stranica i internetskih stranica; dizajn programa za računalna; dizajn programa za uporabu s tiskarskim strojevima; dizajn proizvoda; dizajn proizvodnih metoda; dizajn prototipa; dizajn računalne mreže za druge; dizajn računalnih konfiguracija klastera; dizajn računalnih mikročipova; dizajn računalnih perifernih uređaja; dizajn računalnih programa; dizajn računalnih specifikacija; dizajn računalnih strojeva i računalnog softvera za komercijalnu analizu i izvještavanje; dizajn računalnih sustava primjenom metode agilnog razvoja; dizajn računalno simuliranih modela; dizajn računalnog hardvera za proizvodnu industriju; dizajn računalnog softvera za druge; dizajn, razvoj i implementacija softvera; dizajn, razvoj i održavanje intraneta; dizajn, razvoj i programiranje računalnih programa; dizajn, skiciranje i pisanje računalnog softvera po narudžbi; dizajn softvera; dizajn softvera operativnog sustava; dizajn softvera računalnih igara; dizajn softvera za obradu digitalnog signala; dizajn softvera za obradu i

distribuciju multimedijjskih sadržaja; dizajn softvera za obradu teksta; dizajn softvera za pretvaranje podataka i multimedijjskog sadržaja iz i u razne protokole; dizajn softvera za računalne baze podataka; dizajn softvera za skladištenje i pristupanje multimedijjskim podacima; dizajn softvera za tehničare zvuka i videa; dizajn softvera za video igre; dizajn tiskanog materijala; graditeljski dizajn; grafički dizajn; grafički dizajn korica knjiga; grafički dizajn promotivnih materijala; grafički dizajn za kompilaciju web stranica na Internetu; ilustracijske usluge (dizajn); industrijski dizajn; industrijski dizajn mobilnih telefona; industrijski dizajn uz pomoć računala; industrijski i grafički dizajn; industrijski umjetnički dizajn; inženjerske usluge za dizajn struktura; inženjerski dizajn; inženjerski dizajn i savjetovanje; istraživanje, razvoj, dizajn i nadogradnja računalnog softvera; izrada i dizajn internetskih indeksa informacija za druge osobe [usluge informacijskih tehnologija]; izrada i dizajn Web stranica za druge; komercijalni umjetnički dizajn; konzultantske i informativne usluge koje se odnose na dizajn, programiranje i održavanje računalnog softvera; konzultantske i informativne usluge koje se odnose na dizajn računalnih programa; konzultantske usluge koje se odnose na dizajn početnih i internetskih stranica; konzultantske usluge koje se odnose na izradu i dizajn internetskih stranica; konzultantske usluge koje se odnose na izradu i dizajn početnih i internetskih stranica za e-trgovinu; konzultantske usluge koje se odnose na dizajn i razvoj računalnih programa; konzultantske usluge koje se odnose na dizajn početnih stranica i internetskih stranica; matematičkih modela (Dizajn -); platforme za grafički dizajn kao softver kao usluga [SaaS]; prilagođeni dizajn računalnog softvera; prilagođeni dizajn računalnog hardvera; računalni dizajn Web stranica; računalni grafički dizajn za mapiranje videoprojekcija; računalno potpomognuti dizajn videografike; računalno potpomognuti dizajn za proizvodne aktivnosti; računalno potpomognuti grafički dizajn; računalno programiranje i dizajn softvera; računalnog softvera (Dizajn -); razvoj, dizajn i ažuriranje početnih stranica; razvoj i dizajn digitalnih nosača zvuka; istraživanje (Znanstveno -); izdavanje znanstvenih podataka; iznajmljivanje znanstvene i tehnološke opreme; iznajmljivanje znanstvenih instrumenata; laboratorijske znanstvene usluge; prikupljanje znanstvenih podataka; priprema izvještaja u svezi sa znanstvenim istraživanjima; priprema znanstvenih izvještaja; pružanje usluga ispitivanja [znanstvenih]; provedba znanstvenih studija; pružanje informacija i rezultata o znanstvenim istraživanjima iz baze podataka koja se može pretraživati na internetu; pružanje informacija o znanstvenoj tehnologiji; pružanje informacija u svezi sa znanstvenim istraživanjem; pružanje znanstvenih informacija u području medicinskih poremećaja i njihova liječenja; pružanje znanstvenih podataka; računalno potpomognuto znanstveno ispitivanje; savjetodavne usluge u svezi sa znanstvenim instrumentima; savjetodavne usluge u svezi sa znanstvenim istraživanjem; usluge računalno potpomognute znanstvene analize; usluge savjetnika na području znanstvenog istraživanja; usluge znanstvenih ispitivanja; usluge znanstvenog istraživanja; usluge znanstvenog računalnog programiranja; znanstvena analiza; znanstvena i tehnološka istraživanja u vezi s kartiranjem patenata; znanstvena i tehnološka istraživanja za mapiranje patenata; znanstvena istraživanja; znanstvena procjena rizika; znanstvene i tehnološke usluge; znanstvene savjetodavne usluge; znanstvene tehnološke usluge; znanstvene usluge; znanstvene usluge i istraživanja s njima u svezi; znanstvene usluge i projektiranje s njima u svezi; znanstvene usluge projektiranja; znanstveni i tehnološki dizajn; znanstveno i industrijsko istraživanje; znanstveno istraživanje; znanstveno istraživanje i analiza; znanstveno istraživanje i razvoj; znanstveno istraživanje na polju socijalne medicine; znanstveno istraživanje provedeno korištenjem baza podataka; znanstveno savjetovanje; zračno daljinsko opažanje u svezi sa znanstvenim istraživanjima; zračno daljinsko praćenje u svezi sa znanstvenim istraživanjima; istraživanje i razvoj novih proizvoda; istraživanje i razvoj novih proizvoda [za treće osobe]; istraživanje i razvoj proizvoda; istraživanje i razvoj računalnog softvera; istraživanje u području tehnologije obrade podataka; istraživanje u svezi s obradom podataka; istraživanje (Znanstveno -); programiranje softvera za istraživanje tržišta; projektna istraživanja (Tehnička -); projektna istraživanja u svezi sa softverom; pružanje

informacija na Internetu o uslugama industrijske analize i istraživanja; pružanje informacija o tehnološkom istraživanju; pružanje informacija o uslugama industrijske analize i istraživanja; pružanje informacija u svezi sa znanstvenim istraživanjem; pružanje istraživačkih usluga; pružanje online informacija u području tehnološkog istraživanja iz računalne baze podataka ili Interneta; psihološko istraživanje; razvoj (Istraživanje i -) proizvoda; savjetodavne usluge u svezi s tehnološkim istraživanjem; savjetodavne usluge u svezi sa znanstvenim istraživanjem; tehnološko istraživanje; usluge istraživanja za razvoj novih proizvoda; usluge računalnog istraživanja; usluge savjetnika na području znanstvenog istraživanja; usluge savjetovanja i istraživanja u svezi s računalnim softverom; usluge savjetovanja i istraživanja u svezi s računalnim hardverom; usluge tehničkog istraživanja; vođenje inženjerskih istraživanja; znanstvena istraživanja; znanstvene usluge i istraživanja s njima u svezi; znanstveno istraživanje; znanstveno istraživanje i analiza; znanstveno istraživanje i razvoj računalnim softverom; usluge savjetovanja o softveru koji se koristi u području e trgovine; usluge savjetovanja u području softvera kao usluge (SAAS); usluge softverskog inženjeringa za programe obrade podataka; usluge softverskog inženjerstva za obradu podataka; usluge stručnog savjetovanja u svezi s računalnim softverom; ažuriranje i dizajn računalnog softvera; ažuriranje i održavanje računalnog softvera; ažuriranje i održavanje računalnog softvera i programa; ažuriranje i unapređivanje računalnog softvera; ažuriranje računalnog softvera; ažuriranje računalnog softvera u svezi s računalnom sigurnosti i prevencijom računalnog rizika; ažuriranje računalnog softvera za druge; ažuriranje softvera; ažuriranje softvera za komunikacijske sustave; ažuriranje softvera za obradu podataka; ažuriranje softvera za ugrađene uređaje; ažuriranje softverskih baza podataka; dizajn, ažuriranje i održavanje računalnog softvera; dizajn grafičkih softverskih sustava; dizajn i ažuriranje računalnog softvera; dizajn i pisanje računalnog softvera; dizajn i razvoj arhitekture računalnog softvera; dizajn i razvoj operativnog softvera za pristup i korištenje mreža računarstva u oblaku; dizajn i razvoj operativnog softvera za računalne mreže i servere; dizajn i razvoj računalnog softvera; dizajn i razvoj računalnog softvera za upravljanje opskrbnim lancem; dizajn i razvoj računalnog softvera za upravljanje bazama podataka; dizajn, održavanje i ažuriranje računalnog softvera; dizajn, održavanje i ažuriranje računalnog softvera; dizajn, održavanje i ažuriranje računalnog softvera; dizajn online softvera za društvene mreže; dizajn računalnih strojeva i računalnog softvera za komercijalnu analizu i izvještavanje; dizajn računalnog softvera za druge; dizajn, razvoj i implementacija softvera; dizajn, skiciranje i pisanje računalnog softvera po narudžbi; dizajn softvera; dizajn softvera operativnog sustava; dizajn softvera računalnih igara; iznajmljivanje računalnog softvera za prikupljanje, analizu i organiziranje podataka u području dubokog učenja; iznajmljivanje softvera; iznajmljivanje softvera za uvoz i upravljanje podacima; iznajmljivanje softvera za razvoj internetskih stranica; iznajmljivanje softvera za upravljanje bazama podataka; iznajmljivanje softvera za računalne baze podataka; iznajmljivanje softvera za obradu podataka; iznajmljivanje softvera za računalne igre; izrada, održavanje i prilagođivanje softvera; izrada računalnih programa [softvera]; izrada računalnog softvera; konzultantske usluge u području sigurnosnog softvera; konzultantske usluge u svezi s računalima i softverom; konzultantske usluge u svezi sa softverom; konzultantske usluge u svezi s računalnim softverom; nadogradnja računalnog softvera; programiranje obrazovnog softvera; savjetodavne i konzultantske usluge u vezi sa softverom računala i videogrica; savjetodavne i razvojne usluge koje se odnose na računalni softver; savjetodavne usluge na području razvoja i poboljšanja kakvoće softverskih proizvoda; savjetodavne usluge u svezi s računalnim softverom korištenim u izdavaštvu; savjetodavne usluge u svezi s dizajnom računalnog softvera; savjetodavne usluge u svezi s računalnim softverom korištenim u grafičke svrhe; savjetodavne usluge u svezi sa sučeljima za interakciju čovjeka i stroja za računalni softver; savjetodavne usluge u svezi s računalnim softverom korištenim za ispis; savjetodavne usluge u svezi s korištenjem računalnog softvera; savjetodavne usluge u svezi s iznajmljivanjem računala ili računalnog

softvera; savjetovanje koje se odnosi na dizajn i razvoj softvera; savjetovanje u području dizajniranja softvera; softver kao usluga [SaaS] sa softverom za dubinsko učenje; usluge savjetovanja i istraživanja u svezi s dizajnom i razrada informatičkih sustava; dupliciranje informatičkih programa; hosting informatičkih stranica; informatičke stranice [ugošćavanje informatičkih stranica]; informatičko-tehnološke usluge za zaštitu podataka; informativne usluge u svezi s informacijskom tehnologijom; informativne usluge u svezi s računalima; informativne usluge u svezi s primjenom računalnih mreža; informativne usluge u svezi s razvojem računalnih mreža; informativne usluge u svezi s primjenom računalnih sustava; informativne usluge u svezi s razvojem računalnih sustava; iznajmljivanje informatičkih programa; iznajmljivanje informatičkih programa; konzultantske i informativne usluge koje se odnose na dizajn, programiranje i održavanje računalnog softvera; konzultantske i informativne usluge koje se odnose na dizajn računalnih programa; konzultantske i informativne usluge koje se odnose na integraciju računalnih sustava; konzultantske i informativne usluge koje se odnose na računalno programiranje; konzultantske i informativne usluge koje se odnose na održavanje računalnih programa; konzultantske i informativne usluge koje se odnose na informacijsku tehnologiju; konzultantske i informativne usluge koje se odnose na arhitekturu i infrastrukturu informacijske tehnologije; konzultantske i informativne usluge koje se odnose na iznajmljivanje računalnih programa; konzultantske usluge za analiziranje informativnih sustava; konzultantske usluge za projektiranje informativnih sustava; osmišljavanje informatičkih sustava; prikupljanje podataka u svezi s informativnim sustavima; pružanje stručnih izvještaja u svezi s računalstvom [informatika]; pružanje stručnih procjena u svezi s računalstvom [informatika]; savjetodavne i informativne usluge koje se odnose na računalne periferne uređaje; savjetodavne i informativne usluge koje se odnose na računalne programe; savjetodavne usluge u svezi s računalnim informativnim sustavima; upravljanje informatičkim projektima; zaštita od informatičkih virusa

(511)

41 podučavanje dizajna interijera

42 dizajn interijera; usluge dizajna interijera te informacije i savjetodavne usluge u svezi s tim; informativne usluge u svezi s usklađivanjem boja, slika i namještaja pri dizajnu interijera; informativne usluge u svezi s kombinacijom boja, slika i namještaja pri dizajnu interijera; savjetovanje u svezi s odabirom laganih prekrivača za namještaj [dizajn interijera]; savjetovanje u svezi s odabirom tkanina za namještaj [dizajn interijera]; savjetovanje u svezi s odabirom zavjesa [dizajn interijera]; konzultantske usluge u svezi s dizajnom interijera; tehničke konzultacije na polju dizajna interijera; usluge dizajna interijera i eksterijera; savjetodavne usluge za dizajn interijera; arhitektonski dizajn za ukrašavanje interijera; dizajn interijera trgovina; dizajn komercijalnog interijera; dizajn dekora interijera za trgovine

(210) Z20240068A

(220)

25.01.2024.

(442)

15.03.2024.

(731)

**Asja Kraljević**

Zamenhofova 8, 10000 Zagreb, HR

(540)



(591)

tamnoplava, crvena, tamnoroza, bordo

(531)

02.03.01; 02.03.23; 02.03.24; 27.05.01; 27.05.09; 27.05.10; 24.17.25

(511)

41 administriranje [organiziranje] kulturnih aktivnosti; administriranje [organiziranje] usluga za zabavu; dogovaranje, izvođenje i organizacija kongresa; dogovaranje, izvođenje i organizacija simpozija; dogovaranje, izvođenje i organizacija seminara; dopisni tečajevi, učenje na daljinu; dopunska poduka; informacije o obrazovanju; informacije u svezi s rekreacijom; izložbi (vođenje -) u obrazovne svrhe; izvođenje sportskih događanja uživo; konzultantske i informativne usluge koje se odnose na pripremu, izvođenje i organizaciju kongresa; konzultantske i informativne usluge koje se odnose na pripremu, izvođenje i organizaciju seminara; konzultantske usluge koje se odnose na obrazovanje i osposobljavanje; objavljivanje tekstova; objavljivanje priručnika; objavljivanje obrazovnih tekstova; objavljivanje tiskovina, uključujući u elektroničkom obliku, osim za reklamne svrhe; objavljivanje tiskanog materijala i tiskanih publikacija; objavljivanje tiskanog materijala; vođenje tečajeva, seminara i radionica; vođenje seminara i kongresa; vođenje tečajeva; vođenje predavanja o kontroli tjelesne težine; vođenje predavanja o tjelovježbi; vođenje radionica i seminara za procjenu osobne svijesti; vođenje radionica i seminara na temu samosvijesti

(210) Z20231249A

(220)

19.12.2023.

(442)

15.03.2024.

(731)

**L.A.N.A. Banely d.o.o.**

Hercegovačka ulica 81, 10000 Zagreb, HR

(740)

Barbara Banely, Zagreb, HR

(540)



(591)

zlatna, svijetlo zlatna, tamno zlatna

(531)

27.05.01

## Kazalo brojeva prijava žigova

Broj prijave žiga (210)	Klasifikacijska oznaka razreda (511)	Broj prijave žiga (210)	Klasifikacijska oznaka razreda (511)
Z20220472A	29, 30, 33	Z20231287A	9, 37
Z20230978A	9, 11, 37	Z20240003A	34, 35
Z20230988A	9	Z20240004A	9, 14, 42
Z20231042A	5	Z20240006A	9
Z20231077A	12, 35	Z20240012A	4, 5, 14, 16, 20, 21, 22, 24, 25, 26, 28, 29, 30, 31, 32, 33, 36, 39, 41, 43
Z20231089A	30, 32, 35, 43	Z20240030A	35, 37, 39, 43
Z20231090A	9, 42	Z20240031A	35, 37, 39, 43
Z20231128A	41, 42	Z20240032A	35, 37, 39, 43
Z20231133A	36, 42	Z20240034A	28
Z20231134A	36, 42	Z20240035A	35, 39, 41, 42
Z20231136A	36, 42	Z20240036A	35, 39, 41, 42
Z20231137A	36, 42	Z20240039A	35, 43
Z20231139A	36, 42	Z20240063A	30
Z20231140A	36, 42	Z20240065A	9, 37, 42
Z20231157A	5, 10, 35, 39, 41, 44	Z20240066A	5
Z20231162A	9	Z20240067A	35, 41, 44
Z20231210A	2, 4, 7, 8, 9, 12, 17, 36, 39	Z20240068A	41
Z20231249A	41, 42	Z20240105A	9, 42
Z20231268A	16, 32, 39	Z20240128A	36
Z20231269A	16, 32, 39	Z20240130A	32
Z20231279A	29	Z20240131A	32
Z20231280A	29	Z20240164A	29
Z20231281A	29	Z20240165A	29
Z20231284A	30		
Z20231285A	30		

# Kazalo klasifikacijskih oznaka prijave žigova

Klasifikacijska oznaka razreda (511); Podnositelj prijave (731) Broj prijave žiga (210)

Klasifikacijska oznaka razreda (511); Podnositelj prijave (731) Broj prijave žiga (210)

**RAZRED 2**

AUTO HRVATSKA dioničko društvo ..... Z20231210A

**RAZRED 4**

AUTO HRVATSKA dioničko društvo ..... Z20231210A  
 JAVNA USTANOVA "PARK  
 PRIRODE LONJSKO POLJE" ..... Z20240012A

**RAZRED 5**

Corteva Agriscience LLC ..... Z20240066A  
 JAVNA USTANOVA "PARK  
 PRIRODE LONJSKO POLJE" ..... Z20240012A  
 Ljekarna Pablo ..... Z20231157A  
 TEVA PHARMACEUTICALS  
 EUROPE B.V. .... Z20231042A

**RAZRED 7**

AUTO HRVATSKA dioničko društvo ..... Z20231210A

**RAZRED 8**

AUTO HRVATSKA dioničko društvo ..... Z20231210A

**RAZRED 9**

ABC Informatic d.o.o. .... Z20231090A  
 ADNETH d.o.o. .... Z20240105A  
 AUTO HRVATSKA dioničko društvo ..... Z20231210A  
 Enhance Production Limited ..... Z20240004A  
 Helb d.o.o. .... Z20240065A  
 Hvaljen Budi d.o.o. .... Z20231162A  
 Jobs d.o.o. .... Z20240006A  
 NOVAMINA centar inovativnih  
 tehnologija, d.o.o. .... Z20231287A  
 QUANTUM BIT d.o.o. .... Z20230988A  
 SOLAR LEKTUS d.o.o. .... Z20230978A

**RAZRED 10**

Ljekarna Pablo ..... Z20231157A

**RAZRED 11**

SOLAR LEKTUS d.o.o. .... Z20230978A

**RAZRED 12**

AUTO HRVATSKA dioničko društvo ..... Z20231210A  
 Banić Neno ..... Z20231077A

**RAZRED 14**

Enhance Production Limited ..... Z20240004A  
 JAVNA USTANOVA "PARK  
 PRIRODE LONJSKO POLJE" ..... Z20240012A

**RAZRED 16**

JAVNA USTANOVA "PARK  
 PRIRODE LONJSKO POLJE" ..... Z20240012A  
 PLODINE d.d. za trgovinu i usluge ..... Z20231268A, Z20231269A

**RAZRED 17**

AUTO HRVATSKA dioničko društvo ..... Z20231210A

**RAZRED 20**

JAVNA USTANOVA "PARK  
 PRIRODE LONJSKO POLJE" ..... Z20240012A

**RAZRED 21**

JAVNA USTANOVA "PARK  
 PRIRODE LONJSKO POLJE" ..... Z20240012A

**RAZRED 22**

JAVNA USTANOVA "PARK  
 PRIRODE LONJSKO POLJE" ..... Z20240012A

**RAZRED 24**

JAVNA USTANOVA "PARK  
 PRIRODE LONJSKO POLJE" ..... Z20240012A

**RAZRED 25**

JAVNA USTANOVA "PARK  
 PRIRODE LONJSKO POLJE" ..... Z20240012A

**RAZRED 26**

JAVNA USTANOVA "PARK  
 PRIRODE LONJSKO POLJE" ..... Z20240012A

**RAZRED 28**

JAVNA USTANOVA "PARK  
 PRIRODE LONJSKO POLJE" ..... Z20240012A  
 Mattel Inc. .... Z20240034A

**RAZRED 29**

ATELIER ECOSTYLE j.d.o.o. .... Z20220472A  
 GRAD ROVINJ-ROVIGNO ..... Z20220472A  
 JAVNA USTANOVA "PARK  
 PRIRODE LONJSKO POLJE" ..... Z20240012A  
 PIK VRBOVEC plus d.o.o. .... Z20240164A, Z20240165A  
 PUĐA d.o.o. .... Z20231279A, Z20231280A  
 ..... Z20231281A  
 TURISTIČKA ZAJEDNICA GRADA  
 ROVINJA-ROVIGNO ..... Z20220472A

**RAZRED 30**

ATELIER ECOSTYLE j.d.o.o. .... Z20220472A  
 FITSTOP BAR j.d.o.o. .... Z20231089A  
 GRAD ROVINJ-ROVIGNO ..... Z20220472A  
 JAVNA USTANOVA "PARK  
 PRIRODE LONJSKO POLJE" ..... Z20240012A  
 Kandit d.o.o. .... Z20240063A  
 Reizl d.o.o. .... Z20231284A, Z20231285A  
 TURISTIČKA ZAJEDNICA GRADA  
 ROVINJA-ROVIGNO ..... Z20220472A

Klasifikacijska oznaka razreda (511); Podnositelj prijave (731) Broj prijave žiga (210)

**RAZRED 31**JAVNA USTANOVA "PARK  
PRIRODE LONJSKO POLJE" ..... Z20240012A**RAZRED 32**ATLANTIC CEDEVITA d.o.o. .... Z20240130A, Z20240131A  
FITSTOP BAR j.d.o.o. .... Z20231089A  
JAVNA USTANOVA "PARK  
PRIRODE LONJSKO POLJE" ..... Z20240012A  
PLODINE d.d. za trgovinu i usluge ..... Z20231268A, Z20231269A**RAZRED 33**ATELIER ECOSTYLE j.d.o.o. .... Z20220472A  
GRAD ROVINJ-ROVIGNO ..... Z20220472A  
JAVNA USTANOVA "PARK  
PRIRODE LONJSKO POLJE" ..... Z20240012A  
TURISTIČKA ZAJEDNICA GRADA  
ROVINJA-ROVIGNO ..... Z20220472A**RAZRED 34**

TDR d.o.o. .... Z20240003A

**RAZRED 35**Banić Neno ..... Z20231077A  
FITSTOP BAR j.d.o.o. .... Z20231089A  
Ljekarna Pablo ..... Z20231157A  
Milijević Nikola ..... Z20240035A, Z20240036A  
Raguž Ivan ..... Z20240067A  
TDR d.o.o. .... Z20240003A  
TECTUS d.o.o. .... Z20240035A, Z20240036A  
Trgovina Krk d.d. .... Z20240030A, Z20240031A  
..... Z20240032A  
UDRUGA JEDINSTVENIH  
HRVATSKIH HOTELA STORIES ..... Z20240039A**RAZRED 36**AUTO HRVATSKA dioničko društvo ..... Z20231210A  
JAVNA USTANOVA "PARK  
PRIRODE LONJSKO POLJE" ..... Z20240012A  
Nova Investment Management  
Limited ..... Z20240128A  
Plejić Stipe ..... Z20231133A, Z20231134A  
..... Z20231136A, Z20231137A  
..... Z20231139A, Z20231140A**RAZRED 37**Helb d.o.o. .... Z20240065A  
NOVAMINA centar inovativnih  
tehnologija, d.o.o. .... Z20231287A  
SOLAR LEKTUS d.o.o. .... Z20230978A

Klasifikacijska oznaka razreda (511); Podnositelj prijave (731) Broj prijave žiga (210)

Trgovina Krk d.d. .... Z20240030A, Z20240031A  
..... Z20240032A**RAZRED 39**AUTO HRVATSKA dioničko društvo ..... Z20231210A  
JAVNA USTANOVA "PARK  
PRIRODE LONJSKO POLJE" ..... Z20240012A  
Ljekarna Pablo ..... Z20231157A  
Milijević Nikola ..... Z20240035A, Z20240036A  
PLODINE d.d. za trgovinu i usluge ..... Z20231268A, Z20231269A  
TECTUS d.o.o. .... Z20240035A, Z20240036A  
Trgovina Krk d.d. .... Z20240030A, Z20240031A  
..... Z20240032A**RAZRED 41**JAVNA USTANOVA "PARK  
PRIRODE LONJSKO POLJE" ..... Z20240012A  
Kraljević Asja ..... Z20240068A  
L.A.N.A. Banely d.o.o. .... Z20231249A  
Ljekarna Pablo ..... Z20231157A  
Milijević Nikola ..... Z20240035A, Z20240036A  
Radas Nataša ..... Z20231128A  
Raguž Ivan ..... Z20240067A  
TECTUS d.o.o. .... Z20240035A, Z20240036A**RAZRED 42**ABC Informatic d.o.o. .... Z20231090A  
ADNET d.o.o. .... Z20240105A  
Enhance Production Limited ..... Z20240004A  
Helb d.o.o. .... Z20240065A  
L.A.N.A. Banely d.o.o. .... Z20231249A  
Milijević Nikola ..... Z20240035A, Z20240036A  
Plejić Stipe ..... Z20231133A, Z20231134A  
..... Z20231136A, Z20231137A  
..... Z20231139A, Z20231140A  
Radas Nataša ..... Z20231128A  
TECTUS d.o.o. .... Z20240035A, Z20240036A**RAZRED 43**FITSTOP BAR j.d.o.o. .... Z20231089A  
JAVNA USTANOVA "PARK  
PRIRODE LONJSKO POLJE" ..... Z20240012A  
Trgovina Krk d.d. .... Z20240030A, Z20240031A  
..... Z20240032A  
UDRUGA JEDINSTVENIH  
HRVATSKIH HOTELA STORIES ..... Z20240039A**RAZRED 44**Ljekarna Pablo ..... Z20231157A  
Raguž Ivan ..... Z20240067A

# Kazalo podnositelja prijava žigova

Podnositelj prijave (731)	Broj prijave žiga (210)	Podnositelj prijave (731)	Broj prijave žiga (210)
ABC Informatic d.o.o.	Z20231090A	PIK VRBOVEC plus d.o.o.	Z20240164A, Z20240165A
ADNET d.o.o.	Z20240105A	Plejić Stipe	Z20231133A, Z20231134A
ATELIER ECOSTYLE j.d.o.o.	Z20220472A		Z20231136A, Z20231137A
ATLANTIC CEDEVITA d.o.o.	Z20240130A, Z20240131A		Z20231139A, Z20231140A
AUTO HRVATSKA dioničko društvo	Z20231210A	PLODINE d.d. za trgovinu i usluge	Z20231268A, Z20231269A
Banić Neno	Z20231077A	PUĐA d.o.o.	Z20231279A, Z20231280A
Corteva Agriscience LLC	Z20240066A		Z20231281A
Enhance Production Limited	Z20240004A	QUANTUM BIT d.o.o.	Z20230988A
FITSTOP BAR j.d.o.o.	Z20231089A	Radas Nataša	Z20231128A
GRAD ROVINJ-ROVIGNO	Z20220472A	Raguž Ivan	Z20240067A
Helb d.o.o.	Z20240065A	Reizl d.o.o.	Z20231284A, Z20231285A
Hvaljen Budi d.o.o.	Z20231162A	SOLAR LEKTUS d.o.o.	Z20230978A
JAVNA USTANOVA "PARK PRIRODE LONJSKO POLJE"	Z20240012A	TDR d.o.o.	Z20240003A
Jobs d.o.o.	Z20240006A	TECTUS d.o.o.	Z20240035A, Z20240036A
Kandit d.o.o.	Z20240063A	TEVA PHARMACEUTICALS EUROPE B.V.	Z20231042A
Kraljević Asja	Z20240068A	Trgovina Krk d.d.	Z20240030A, Z20240031A
L.A.N.A. Banely d.o.o.	Z20231249A		Z20240032A
Ljekarna Pablo	Z20231157A	TURISTIČKA ZAJEDNICA GRADA ROVINJA-ROVIGNO	Z20220472A
Mattel Inc.	Z20240034A	UDRUGA JEDINSTVENIH HRVATSKIH HOTELA STORIES	Z20240039A
Milljević Nikola	Z20240035A, Z20240036A		
Nova Investment Management Limited	Z20240128A		
NOVAMINA centar inovativnih tehnologija, d.o.o.	Z20231287A		



# Objava upisa promjena u Registru prijava žigova













## Ograničenje popisa proizvoda i usluga

Broj prijave žiga	Datum objave prijave za registraciju žiga	Popis proizvoda i usluga za koje žig nastavlja vrijediti	Datum upisa promjene
(210)	(442)	(511)	(580)
Z20220664A	23.12.2022	<p>1 kemijske i organske mješavine i tvari za obradu kože i tekstila; deterdženti za uporabu u proizvodnji i industriji; prirodni i sintetički mediji za uzgoj bilja; prirodni mikroorganizmi za održavanje ribnjaka; polisaharidi za uporabu u konzerviranju; polisaharidi za uporabu u vezivanju; polisaharidi za potrebe aromatiziranja; biološki pripravci za uporabu u proizvodnji; proteini za uporabu u fermentacijskoj tehnologiji; proteini za vezivanje protutijela [nisu za medicinsku uporabu]; proteini za uporabu u proizvodnji; škrobovi za uporabu u proizvodnji i industriji; soli za industrijske svrhe; neprerađene umjetne i sintetičke smole; neprerađena plastika; materijali za filtriranje [mineralne tvari]; materijali za filtriranje [kemijski, mineralni, biljni i ostali neprerađeni materijali]; kitovi, punila i paste za uporabu u industriji; kitovi i druga punila u obliku paste; kitovi [ispune]; kemijski pripravci i materijali za film, fotografiju i tiskanje; kemijski pripravci za brtvljenje; kemijske tvari, kemijski materijali i kemijski pripravci te prirodni elementi; deterdženti za uporabu u industrijskim procesima; deterdženti za uporabu u proizvodnim procesima; biorazgradljivi deterdženti za uporabu u proizvodnim procesima; polimeri za uporabu u analizi proteina; kemijske i organske mješavine za korištenje u proizvodnji hrane i pića; polisaharidi za uporabu u proizvodnji hrane; organski spojevi za uporabu u proizvodnji dječjih pelena; aditivi (kemijski i organski) za uporabu u obrađivanju plastike; aditivi (kemijski i organski) za uporabu u plastici; organski prah i pripravci za poboljšavanje tla; mješavine kemijskih proizvoda i mikroorganizama za obogaćivanje komposta; organska zemlja za lončanice; mješavine komposta obogaćene organskim tvarima; organski komposti; organski sulfonati; organski digestat [gnojivo]; gnojiva (Organska -); organska gnojiva; organski halogenidi; kemijski aditivi za insekticide; aditivi (Kemijski -) za tlo; sirovi proteini za uporabu u industriji; sirovi proteini za uporabu u proizvodnji; proteini za uporabu u znanosti; protein koji se koristi u izradi kozmetike; proteini za uporabu u proizvodnji dodataka prehrani; proteini za uporabu u industriji; proteini za ljudsku hranu koji stvaraju emulzije kao dio proizvodnog procesa; proteini za ljudsku hranu koji stvaraju gelove kao dio proizvodnog procesa; protein za ljudsku hranu [sirovina]; proteini za prehrambenu industriju; prehrambeni protein kao sirovina; proteinska plastika; sirovi proteini; protein [sirovina]; hrana za lišće; hrana za biljke s mikroelementima; hrana za biljke; nadomjesci za šećer (Kemijski -); biljke (pripravci za reguliranje rasta biljaka); pripravci za regulaciju rasta biljaka; biljni supstrati; bakteriološki preparati za uporabu u poljoprivredi; bakteriološki preparati za uporabu u hortikulturi; bakterijski preparati [osim za medicinske ili veterinarske potrebe]; bakterijski preparati za uporabu u poljoprivredi; bakterijski preparati za uporabu u hortikulturi; bakterijski preparati za uporabu u šumarstvu; aktivatori rasta biljaka koji sadrže mikroorganizme; aditivi za silažu [konzervansi]; aditivi za sadnju za lakše puštanje korijenja; aditivi za tlo [gnojiva]; aditivi za tlo; aktivatori komposta; biognojiva za obradu sjemena; biognojiva za obradu tla; dušična biognojiva; biognojiva; mediji za uzgajanje biljaka; mediji za uzgajanje, gnojiva i kemikalije za primjenu u poljoprivredi, hortikulturi i šumarstvu; gnojivo</p> <p>5 biološki pripravci za liječenje raka; mikrobnii pripravci protiv raka; proteinski prehrambeni dodaci za životinje</p> <p>9 informacijska tehnologija te uređaji za reprodukciju zvučnih zapisa, videozapisa i multimedijских sadržaja te uređaji za fotografiranje; uređaji za mjerenje, otkrivanje, praćenje i kontroliranje; softver za poslovnu tehnologiju</p> <p>19 vrata, ulazna vrata, prozori i pokrovi za prozore, ne od metala; strukture i prijenosne konstrukcije, ne od metala; kipovi i umjetnička djela od materijala kao što su kamen, beton i mramor, obuhvaćeni ovim razredom; građevinski i konstrukcijski materijali i elementi izrađeni od pijeska, kamena, stijena, gline, minerala i betona; nemetalni građevinski materijali za zaštitu od propuha; nemetalni građevinski materijali za ravnanje; nemetalni građevinski materijali koji imaju akustična svojstva; nemetalni građevinski i konstrukcijski materijali; nemetalni krovni obrubi; obrubi (Nemetalni -); vlaknate [građevinski materijali]; nemetalni gotovi građevinski elementi; montažni građevinski elementi (Nemetalni -); obrubi [nemetalni građevinski elementi]; nemetalni građevinski fasadni elementi; nemetalni građevinski materijali; agregati [građevinski materijali]; agregat [građevinski materijal]; građevinski materijali (nemetalni)</p> <p>29 escamoles [jestive ličinke mrava, pripremljene]; pripremljeni kukci i ličinke; jestivi kukci, neživi</p> <p>30 tortilla grickalice; polisaharidi kao prehrana za ljudsku konzumaciju; nadomjesci za šećer</p> <p>31 mamci za ribe u obliku kuglica [živi ili prirodni]; prirodni mamac; živi insekti; hrana i stočna hrana; hrana za morske životinje; hrana za domaće životinje; hrana za životinje; prerađene žitarice za životinjsku prehranu; jestivi kukci, živi</p> <p>32 pivo i pivarski proizvodi; pripravci za pripremu pića; pivo i bezalkoholno pivo; bezalkoholno pivo; pivo; bezalkoholna pića</p>	06.03.2024

# Objava informacija o međunarodnim registracijama žigova za koje je zatražena zaštita u Republici Hrvatskoj

Gazette OMPI des marques internationales/  
WIPO Gazette of International Marks  
broj 07/2024 (veljača 2024.)

## 1. Registracije (Enregistrements/Registration):

Broj m.r.: 1777595 Datum reg.: 01.09.2023. Znak:	Podrijetlo: RU Razred(i): 9	Podrijetlo: JP Razred(i): 28	Nositelj: KRKA, tovarna zdravil, d.d., Novo mesto
	Broj m.r.: 1777707 Datum reg.: 22.12.2023. Znak:	Broj m.r.: 1777937 Datum reg.: 27.09.2023. Znak:	Podrijetlo: SI Razred(i): 5
Nositelj: BLOOMAGE BIOTECHNOLOGY CORPORATION LIMITED	היה עצמך בכל נשימה	STOLI SPIRIT OF CHANGE	Broj m.r.: 1778424 Datum reg.: 15.11.2023. Znak:
Podrijetlo: CN Razred(i): 1, 3, 5	Nositelj: Zielinski and Rozen perfumerie LLC	Nositelj: ST 1 IP Sàrl Podrijetlo: CH Razred(i): 33	
Broj m.r.: 1777664 Datum reg.: 06.12.2023. Znak:	Podrijetlo: RU Razred(i): 3	Broj m.r.: 1778082 Datum reg.: 09.10.2023. Znak:	Nositelj: Illyrian Cigars. Inc. Podrijetlo: US Razred(i): 34
	Broj m.r.: 1777711 Datum reg.: 09.11.2023. Znak:		Broj m.r.: 1778586 Datum reg.: 02.09.2023. Znak:
Nositelj: Proizvodno-uslužno preduzeće Export- Import "FLUIDI CORPORATION" d.o.o.		Nositelj: Manxi (Shandong) Cosmetics Co., Ltd. Podrijetlo: CN Razred(i): 3	
Podrijetlo: RS Razred(i): 32	Nositelj: Deutsche Telekom AG Podrijetlo: DE Razred(i): 9, 37, 38, 42	Broj m.r.: 1778266 Datum reg.: 01.02.2024. Znak:	Nositelj: ANHUI COOL BABY SCIENCE & TECHNOLOGY DEVELOPMENT CORPORATION.
Broj m.r.: 1777681 Datum reg.: 04.10.2023. Znak:	Broj m.r.: 1777732 Datum reg.: 07.12.2023. Znak:		Podrijetlo: CN Razred(i): 12, 20
		Nositelj: FERRERO INTERNATIONAL S.A. Podrijetlo: BX Razred(i): 41	Broj m.r.: 1778368 Datum reg.: 15.01.2024. Znak:
Nositelj: Obshchestvo s ogranichennoy otvetstvennostyu "Set data-tsentrov "Selektel"	Nositelj: Koshelev Aleksandr Anatolyevich		Nositelj: KRKA, tovarna zdravil, d.d., Novo mesto
Podrijetlo: RU Razred(i): 3	Broj m.r.: 1777743 Datum reg.: 17.01.2024. Znak:	Nositelj: SI Razred(i): 5	Podrijetlo: SI Razred(i): 5
	Broj m.r.: 1777743 Datum reg.: 17.01.2024. Znak:	Broj m.r.: 1778370 Datum reg.: 15.01.2024. Znak:	
Nositelj: TAMASU CO., LTD.			

## 2. Naknadne designacije (Désignation postérieures/ Subsequent designations)

---

Broj m.r.: 1628870  
Datum reg.: 08.02.2024.  
Znak:



Nositelj: MATRIS TARIM MAKINELERI ZIRAI ÜRÜNLER VEMET.SAN.TİC.LTD.ŞTİ.  
Podrijetlo: TR  
Razred(i): 7, 35

# Objava informacija o međunarodnim registracijama žigova za koje je zatražena zaštita u Republici Hrvatskoj

Gazette OMPI des marques internationales/  
WIPO Gazette of International Marks  
broj 08/2024 (ožujak 2024.)

## 1. Registracije (Enregistrements/Registration):

Broj m.r.: 1778659  
Datum reg.: 27.10.2023.  
Znak:

**marketmind**

Nositelj: marketmind GmbH  
Podrijetlo: AT  
Razred(i): 9, 35, 42

Broj m.r.: 1778856  
Datum reg.: 09.01.2024.  
Znak:

**CLIMBER B.C.**

Nositelj: CÜNO TEKSTİL  
KONFEKSIYON  
SANAYİ VE  
TİCARET LİMİTED  
ŞİRKETİ  
Podrijetlo: TR  
Razred(i): 18, 25

Broj m.r.: 1778964  
Datum reg.: 17.01.2024.  
Znak:

**S.NATURE**

Nositelj: CHO, Yi Seo  
Podrijetlo: KR  
Razred(i): 3

Broj m.r.: 1779058  
Datum reg.: 22.11.2023.  
Znak:



Nositelj: Friotech Kft.  
Podrijetlo: HU  
Razred(i): 11

Broj m.r.: 1779230  
Datum reg.: 26.11.2023.  
Znak:

**eZebra**

Nositelj: EZEBRA.PL  
SPÓŁKA Z  
OGRANICZONĄ  
ODPOWIEDZIALNO  
ŚCIĄ  
Podrijetlo: PL  
Razred(i): 35

Broj m.r.: 1779310  
Datum reg.: 13.11.2023.  
Znak:



Nositelj: BOĞAZIÇI ZİL  
SANAYİ VE  
TİCARET LİMİTED  
ŞİRKETİ  
Podrijetlo: TR  
Razred(i): 15

Broj m.r.: 1779476  
Datum reg.: 09.11.2023.  
Znak:



Nositelj: Deutsche Telekom  
AG  
Podrijetlo: DE  
Razred(i): 35, 38

Broj m.r.: 1779539  
Datum reg.: 18.12.2023.  
Znak:

**PILOTAGE**

Nositelj: MDVF, dizajn in  
trgovina, d.o.o.  
Podrijetlo: SI  
Razred(i): 33

## 2. Naknadne designacije (Désignation postérieures/ Subsequent designations)

---

Broj m.r.: 1518158  
Datum reg.: 26.01.2024.  
Znak:

# Reno

Nositelj: GUANGDONG OPPO MOBILE TELECOMMUNICATIONS CORP., LTD.  
Podrijetlo: CN  
Razred(i): 7, 11, 12, 14, 25, 28, 35, 37, 38, 41, 42

# Objava žigova

## RAZRED 1

(111)	<b>Z20200330</b>	(151)	07.03.2024.
		(450)	15.03.2024.
(210)	Z20200330A	(220)	04.03.2020.
		(181)	<b>04.03.2030.</b>
(732)	<b>PEVEX maloprodaja neprehrambene robe dioničko društvo</b>		
	Savska cesta 84, 10360 Sesvete, HR		
(740)	Vukić, Jelušić, Šulina, Stanković, Jurcan & Jabuka odvjetničko društvo d.o.o., Rijeka, HR		
(540)			



(591) bijela, zelena

(531) 27.05.01; 27.05.10; 29.01.03; 29.01.06

(511)

- 1 kemijski proizvodi za industriju, znanost i fotografsku djelatnost, kao i za ratarstvo, povrtlarstvo, šumarstvo; sirova plastika i umjetna smola; gnojivo; kemijski proizvodi za konzerviranje hrane; ljepila za industriju; mješavine za gašenje požara; preparati za zavarivanje, kaljenje i lemljenje metala; sredstva za štavljenje kože; destilirana voda; etilni alkohol; biološki preparati; kemikalije za fotografije; gnojiva; humus; kemikalije za industriju; hormoni za dozrijevanje voća; proizvodi za uklanjanje kamenca; kiseline; lijepak; otapala za lakove; kemijski proizvodi za konzerviranje prehrambenih namirnica
- 2 boje, lakovi i glazure; zaštita od hrđe te od propadanja i truljenja drva; tvari za bojanje; nagrizajuće tvari; prirodne sirove smole; metali u listovima i prahu
- 3 brusni papir
- 5 proizvodi za uništavanje životinjskih štetočina; fungicidi i herbicidi; dezinfekcijska sredstva; farmaceutski i veterinarski proizvodi; higijenski proizvodi za upotrebu u medicini; dezinfekcijska sredstva; proizvodi za uništavanje štetočina; sredstva za uništavanje nametnika; herbicidi; fungicidi; proizvodi protiv moljaca; ogrlice protiv nametnika; dezinfekcijski proizvodi za higijenske potrebe; veterinarski proizvodi; proizvodi za osvježavanje i pročišćavanje zraka
- 6 čelik; čelične cijevi; obični metali i njihove legure; metalni građevinski materijali; metalne prenosive konstrukcije; metalni materijali za tračnice; metalna užad i neelektrične metalne žice; metalni bravarski proizvodi i sitni metalni predmeti; metalne cijevi; metalne blagajne; rudače; metalni građevinski materijali; metalne prijenosne konstrukcije; metalna užad; metalni bravarski proizvodi i sitni metalni predmeti; metalni okovi; metalne cijevi; metalne blagajne; neelektrični metalni kablovi i žice; sitna željezna roba; metalne armature za građevinarstvo; antenske žice; metalne armature za pokućstvo; metalne armature za prozore i vrata; metalne bačve; metalna postolja za bačve; metalne slavine za bačve; metalne armature za beton; sefovi; metalne boce za plin; metalne posude; čelik; čelične cijevi; metalni kalupi; ključevi; metalna korita; metalni kotačići za namještaj; metalna oprema za krevete; metalni krovni vijenci; kuke; kutije od metala; lanci; metalne letve; lim; lokoti; metalne ljestve; metalna stubišta; metalne rešetke; nakovnji; metalne ograde; škripci; tračnice; vijci; zasuni; metalni zatvarači za boce i posude; zvona; okviri (metalni okviri prozora); kabine za kupanje (metalne kabine za kupanje); metalni kapci za prozore; klinovi (sitna metalna roba); klinovi (metalni klinovi); metalna koljena za cijevi; metalne košarice; metalni krovni materijali; kvake (metalne kvake za

7

vrata); metalni rukohvati; metalne automatske brave s ključem; metalni ventil koji nisu dijelovi strojeva  
alatni strojevi; motori (osim motora za kopnena vozila); spojke; prijenosni uređaji (osim onih za kopnena vozila); poljoprivredni aparati i strojevi; inkubatori za jaja; strojni alat; bageri; miješalice za beton; strojevi za bojanje; brodski motori; brodski strojevi; električne miješalice za kućanstvo; električni strojevi za glačanje; bušilice; centrifugalne crpke; cilindri strojeva; crpke; čekići obuhvaćeni ovim razredom; dizala; dizalice; dljeta (dijelovi strojeva); drolilice; držači alata (dijelovi strojeva); dubilice; ekspanzijske posude (obuhvaćene ovim razredom); električni mlinci za kućanstvo; električni motori (osim onih za kopnena vozila); električni generatori; glačalice; grablje (dio stroja); strojevi za graviranje; hidraulični motori i turbine; ispušne grane motora; karteri za strojeve i motore; kompresori; kosilice; kućišta strojeva; kuglični ležajevi; električni kuhinjski strojevi; lančane pile; držači ljepljivih traka (strojevi); strojevi za mljevenje mesa; strojevi za obradu metala; mikseri (kuhinjski strojevi); mlinovi; mlatilice; motokultivatori; dijelovi motora; noževi (dijelovi strojeva); opruge (dijelovi strojeva); osovine strojeva; električni otvarači za konzerve; svječice za paljenje; parni strojevi; parni strojni kotlovi; pile; pletači strojevi; pištolji (strojevi) za ekstruziju kita; pištolji za raspršivanje (strojevi); uređaji za zavarivanje; plugovi; poljoprivredni strojevi; strojevi za pranje posuđa; usisivači za prašinu; preše; prijenosni remeni; pročišćivači; ventilatori motora; ralice; rashladni uređaji za motore; remenice; rezačice; sita (strojevi); strojevi za cijedenje rublja; šivači strojevi; tiskarski strojevi; tkalački strojevi; kosilice za travnjake (strojevi); turbine; udarni čekići (strojevi); vrećice za usisivače; vakumske crpke (strojevi); valjci (strojevi); motori (osim motora za kopnena vozila); glodalice (strojevi); blanjalice (strojevi); grozdovi (strojevi za skidanje zrnja s grozdova); hortikulturalni strojevi; kultivatori (strojevi); miješalice (strojevi); pranje sagova (električni strojevi za pranje sagova); rublje (strojevi za pranje rublja); sušilice za rublje (strojevi)

8 ručni alati i sprave s ručnim pokretanjem; jedači pribor; hladno oružje; mehaničke i električne sprave za brijanje; brijači pribor; alat; britve; brusevi; dizalice; bačvarske i tesarske sjekirice; blanje; brijači uređaji; brusevi; svrdla; rezači cijevi; čekići; ručne dizalice; dljeta; držači pila; držači svrdala; grablje; jedači pribor; brusni kameni; ključevi (alat); sprave za uklanjanje korova; kose za košnju; kosilice za travnjake; krampovi; kuhinjske sjekirice; kutno željezo; lopate; mačevi; maljevi; manikerski pribor; matrice (alat); sjeckalice za meso; naprave za mljevenje mesa; noževi; obarači za voće; odvlači; osti; pribor za oštrenje; oštrice; pijuci; pile; pincete; poluge; ručni poljoprivredni alat; sprave za sjeckanje povrća; pribor za graviranje; probijači; prskalice za insekticide; rezači; sablje; sjeckalice za povrće; sjekire; sjekirice; srpovi; stezačice; šila; škare; škripci; turpije; vile; vrtlarske škare; zidarski čekići; žarači

9 aparati za snimanje, prijenos i reprodukciju zvuka i slika; registarske blagajne; računari; oprema za obradu podataka; aparati i instrumenti za vođenje, distribuiranje, transformiranje, akumuliranje, podešavanje i upravljanje električne energije; znanstveni, nautički, geodetski, fotografski i optički aparati i instrumenti; instrumenti za vaganje, mjerenje, signalizaciju, inspekciju, spašavanje i obuku; magnetne podloge za snimanje; akustičke ploče; uređaji za gašenje požara; akumulatori; akustični prekidači; akustične ploče; alarmni uređaji; antene; azbestna odjeća za zaštitu od vatre; azbestne rukavice; bakrena izolirana žica; barometri; baterije; električne brave; brzinomjer; čitači kazeta; čitači kompaktnih diskova; dalekozori; daljinski pisaci; daljinski prekidači; uređaji za daljinsko upravljanje; detektori; diskete; dubinomjeri; dojavljivači požara; električna zvonca; električne utičnice; električne zujalice; električne žice; električni kablovi; električni vodovi; elektrode za zavarivanje

- 11 uređaji za rasvjetu, grijanje, proizvodnju pare, kuhanje, hlađenje, sušenje, ventilaciju, vodoopskrbu i sanitarna oprema; uređaji za klimatizaciju; grijalice; električni uređaji za kuhanje; svjetla za bicikle; toplinske crpke; električni radijatori; grijači vode; grijača tijela; hidranti; hladnjaci; kabine za tuširanje; kade za kupanje; kamini; rashladne komore; kotlovi za grijanje; kuhala; lusteri; mikrovadne pećnice; rashladni ormari; peći; plamenici; plinske svjetiljke; pržionice; pročišćivači; električni roštilji; sanitarne instalacije; slavine; sušilice; svjetiljke; štednjaci; umivaonici; ventilatori; filtri za vodu; zahodi; grijači vode
- 12 vozila za kretanje po zemlji, vodi i zraku; motori za kopnena vozila; automobili; bicikli; brodovi; električna vozila; čamci; vozila hladnjače; kamioni; motocikli; dječja kolica; saonice; traktori; tricikli; ostala vozila i prijevozna sredstva
- 16 papir, karton; ambalaža (za oblaganje i punjenje) od papira ili kartona; pisma (papir za pisma); papirnato stolno rublje; plakati (poster); ručnici papirnati; stolni kompleti od papira; toaletni papir; toaletni ubrusi od papira; papirne maramice; papirne vrećice; papirnati ubrusi; papirnati stolnjaci; papirnati blokovi; podmetači za stol od kartona; kartonski stolni podlošci; kartonski stolni podmetači; tiskarski proizvodi; proizvodi za uvez knjiga; fotografije; pribor za pisanje; ljepljiva za papirne proizvode ili za kućanstvo; slikarski pribor; kistovi; pisači strojevi i uredski pribor (osim namještaja); oprema za podučavanje i poduku (osim aparata); plastični materijali za ambalažu koji nisu obuhvaćeni drugim razredima; tiskarska slova; klišeji; papirnati higijenski rupčići
- 19 nemetalni građevinski materijali; krute nemetalne cijevi za gradnju; asfalt; katran; bitumen; nemetalne prenosive konstrukcije; šperploča; furnir; poluobrađeno drvo (grede, daske, ploče); građevinsko staklo; beton; crijep; daske; dimnjaci; građevno drvo; gips; rezana građa; izolacijsko staklo (za građevinarstvo); kamen; katran; granit; gorski kristal; nemetalna krovista; mramor; opeka; parketi; pijesak; pluto; smola; šindra; šljunak; vapno
- 20 namještaj; zrcala; okviri; dječji krevetići; drvo za grebanje za mačke; drveni paneli za namještaj; ukrasni drveni paneli (namještaj); konzole (namještaj); stoličice bez naslona (taburei); školski namještaj; sjenila za bambus; namještaj od bambusa; drvene bačve; čepovi za boce; drvene panel ploče za pokućstvo; drveni okviri za krevete; hodalice za djecu; jastuci; klupe; stalci za knjige; komode; koralji; košare za rublje; košnice; krojačke lutke; kućice za ptice; kuke za zavjese; drvene ili plastične kutije; ljestve; ladice; lepeze; madrac; ljesovi; naslonjači; vješalice za odjeću; ogledala; okviri za slike; ormari; paravani; pisači stolovi; ploče za oglašavanje; pokućstvo; pseće kućice; postolja računskih strojeva; pultovi; drveni ili plastični sanduci; stalci; stolice; stolovi; šipke za zavjese; trake od drva; uredski namještaj; vosak za košnice; zastori (obuhvaćeni ovim razredom)
- 21 pribor i posuđe za kućanstvo ili za kuhinju, stakleni proizvodi, porculanski i keramički proizvodi koji nisu obuhvaćeni drugim razredima, pribor za čišćenje, češljevi, spužve i četke, sirovo i poluobrađeno staklo; kuhinjsko metalno posuđe, boce, demižoni, čaše, kozmetički pribor, lonci, neelektrični pribor za kućanstvo; metle, košarice za kruh
- 22 šatori
- 31 krmivo (ispaša)
- 35 posredovanje u trgovini; posredovanje u prometu roba i usluga; prodaja i kupnja na malo ili veliko kemijskih proizvoda, boja, bojajućih tvari, preparata za zaštitu od korozije, preparata za bijeljenje i ostalih tvari za pranje rublja, preparata za čišćenje, farmaceutskih preparata i ostalih preparata za medicinske potrebe, običnih sirovih i poluobrađenih metala, proizvoda izrađenih od metala, strojeva, alatnih strojeva i motora, sprava s ručnim pokretanjem koje imaju ulogu alata u raznim profesijama, aparati za snimanje, prijenos ili reprodukciju zvuka ili slike, uređaja za rasvjetu, grijanje, proizvodnju pare, kuhanje, hlađenje, sušenje, ventilaciju, vozila, uređaja za kretanje po vodi ili zraku, proizvoda od papira i kartona, uredske opreme, proizvoda napravljenih od kože, imitacije kože, nemetalnih građevinskih elemenata, namještaja i njegovih dijelova, proizvoda napravljenih od kože, imitacije kože, nemetalnih građevinskih elemenata, namještaja i njegovih dijelova, proizvoda napravljenih od drva, pluta, trske, šiblja, plastičnih proizvoda, sitnog pribora i aparata za kućanstvo i za kuhinju koji se pokreću ručno, toaletnog pribora, staklenih proizvoda, proizvoda od porculana, keramike, gline ili stakla,

tekstila i tekstilnih pokrivača za kućnu uporabu, proizvoda za pokrivanje ili oblaganje u svrhu uređenja već izgrađenih podova i zidova, polica, regala i opreme za izlaganje i skladištenje robe; marketinške usluge; reklamiranje i oglašavanje; agencijski komercijalni poslovi s inozemstvom; domaći agencijski komercijalni poslovi; istraživanje tržišta i ispitivanje javnog mijenja; vršenje trgovačkog posredovanja na domaćem i inozemnom tržištu; oglašavanje i reklamiranje; upravljanje komercijalnih poslova; komercijalna administracija; uredski poslovi

- 36 upravljanje nekretninama; financijski poslovi; monetarni poslovi; osiguranje; usluge iznajmljivanja i procjene nekretnina; financijske usluge "holding" kompanija; krediti; izdavanje kreditnih kartica; usluge osiguranja; financijske analize; iznajmljivanje poljoprivrednih gospodarstava; obročna otpлата; financijske procjene; financijske transakcije; ulaganje sredstava; upravljanje imovinom; zajam na temelju zaloga; zakup nekretnina; lizing
- 37 izgradnja; iznajmljivanje strojeva za gradilišta; iznajmljivanje alata i građevinskog materijala; usluge izgradnje; usluge popravaka ili preinaka objekata; usluge popravaka elektrike, pokretnina, strojeva i alata; nadzor građevinskih radova; održavanje i popravak automobila; usluge održavanja objekata; nadziranje građevinskih radova
- 39 prijevoz, ambalažiranje i skladištenje roba i proizvoda; organiziranje putovanja; ambalažiranje proizvoda; isporuka paketa; istovar; iznajmljivanje skladišta; iznajmljivanje vozila; usluge otpreme; pakiranje proizvoda; pomoć pri prijevozu; posredovanje u prijevozu; prijevoz kamionima, željeznicom i brodom; usluge preseljenja; skladištenje

### RAZRED 3

(111)	<b>Z20230869</b>	(151)	08.03.2024.
		(450)	15.03.2024.
(210)	Z20230869A	(220)	15.09.2023.
		(181)	<b>15.09.2023.</b>
(732)	<b>KERN PHARMA, S.L.</b>		
	c. Venus, 72-Polígono Industrial Colón II, 08228 Terrassa, ES		
(740)	PETOŠEVIĆ d.o.o., Zagreb, HR		
(540)			

## KERNNABIS CBD

(511)	<b>3</b>	nemedicinska kozmetika i toaletni pripravci na bazi konoplje; sapuni; esencijalna ulja
	<b>5</b>	farmaceutski preparati; ulja na bazi konoplje za medicinsku uporabu; probiotski bakterijski pripravci za medicinsku uporabu; dijetalni dodaci ljudskoj prehrani; higijenski pripravci za medicinsku uporabu; dijetetska hrana prilagođena za medicinske potrebe; dijetne tvari na bazi konoplje za ljude

### RAZRED 4

(111)	<b>Z20230541</b>	(151)	08.03.2024.
		(450)	15.03.2024.
(210)	Z20230541A	(220)	01.06.2023.
		(181)	<b>01.06.2023.</b>
(732)	<b>Calima Engineering d.o.o.</b>		
	Josipa Lenca Spodolčeva 10, 51000 Rijeka, HR		
(540)			

## INOMAD.WORLD

(511)	<b>4</b>	vodik [gorivo]
	<b>39</b>	skladištenje električne energije
	<b>42</b>	arhitektura
	<b>43</b>	smještaj za turiste

## RAZRED 5

(111)	<b>Z20230753</b>	(151)	27.02.2024.
		(450)	15.03.2024.
(210)	Z20230753A	(220)	04.08.2023.
		(181)	<b>04.08.2033.</b>
(732)	<b>ATLANTIC CEDEVITA d.o.o.</b>		
(540)	Planinska 15, 10000 Zagreb, HR		

## ONE - obrok za preživljavanje

(511)	<b>5</b>	bomboni za medicinske potrebe; dijetetski šećerni proizvodi prilagođeni za medicinske svrhe; dijetetski i prehrambeni pripravci; dodaci prehrani i dijetetski pripravci; mineralni dodaci prehrani; mješoviti vitaminski pripravci; pića kao dodaci prehrani; pločice za podizanje energije kao zamjena za obrok; pripravci od glukoze za medicinske svrhe; šumeće vitaminske tablete; tablete za suzbijanje apetita; vitaminski pripravci; vitaminski pripravci u obliku prehrambenih dodataka; vitaminski i mineralni pripravci; vitaminski napici; vitaminske tablete; zamjenski obrok u prahu
	<b>30</b>	bomboni; bomboni koji nisu za medicinske svrhe; dražeje [nemedicinski konditorski proizvodi]; nemedicinske pastile; nemedicinski bomboni; pastile [bomboni]; pastile [nemedicinski konditorski proizvodi]; slatkiši (nemedicinski) u obliku bombona; šećerni bomboni (nemedicinski); šećerni bomboni [za prehranu]; tvrdi bomboni
	<b>32</b>	sirupi i ostali bezalkoholni pripravci za pripremanje napitaka; bezalkoholni napitci obogaćeni vitaminima

(111)	<b>Z20230760</b>	(151)	01.03.2024.
		(450)	15.03.2024.
(210)	Z20230760A	(220)	09.08.2023.
		(181)	<b>09.08.2033.</b>
(732)	<b>ALKALOID AD Skopje</b>		
(740)	bul. Aleksandar Makedonski 12, 1000 Skopje, MK		
(540)	ALKALOID LGL d.o.o., Zagreb, HR		

## TOLYZANO

(511)	<b>5</b>	kardiovaskularni farmaceutski proizvodi; farmaceutski pripravci za liječenje hiperkolesterolemije
-------	----------	---

(111)	<b>Z20230863</b>	(151)	01.03.2024.
		(450)	15.03.2024.
(210)	Z20230863A	(220)	13.09.2023.
		(181)	<b>13.09.2033.</b>
(732)	<b>ALKALOID AD Skopje</b>		
(740)	bul. Aleksandar Makedonski 12, 1000 Skopje, MK		
(540)	ALKALOID LGL d.o.o., Zagreb, HR		

## SIWOPSI

(511)	<b>5</b>	protuupalni proizvodi; pripravci za ublažavanje boli; encimi kao dijetni dodatak prehrani
-------	----------	---

(111)	<b>Z20230864</b>	(151)	01.03.2024.
		(450)	15.03.2024.
(210)	Z20230864A	(220)	13.09.2023.
		(181)	<b>13.09.2033.</b>
(732)	<b>ALKALOID AD Skopje</b>		
(740)	bul. Aleksandar Makedonski 12, 1000 Skopje, MK		
(540)	ALKALOID LGL d.o.o., Zagreb, HR		

## LOTIMEZ

(511) **5** protugljivična sredstva

(111)	<b>Z20230867</b>	(151)	08.03.2024.
		(450)	15.03.2024.
(210)	Z20230867A	(220)	15.09.2023.
		(181)	<b>15.09.2033.</b>
(732)	<b>KERN PHARMA, S.L.</b>		
(740)	c. Venus, 72-Polígono Industrial Colón II, 08228 Terrassa, ES		
(540)	PETOŠEVIĆ d.o.o., Zagreb, HR		

## REDIGEST PRO

(511)	<b>5</b>	farmaceutski preparati; digestivna sredstva za farmaceutske potrebe; hranjivi dodaci za medicinske potrebe; probiotički pripravci za medicinske potrebe kao pomoć pri održavanju prirodne ravnoteže flore u probavnom sustavu; farmaceutski preparati za liječenje poremećaja probavnog sustava; farmaceutski pripravci i tvari za liječenje gastrointestinalnih bolesti; gastrointestinalni pripravci; sredstva za čišćenje (purgativi); antacidi; laksativi; prehrambena vlakna za pomoć probavi; farmaceutska sredstva koja utječu na probavne organe; lijekovi za crijevne poremećaje
-------	----------	---

(111)	<b>Z20230868</b>	(151)	29.02.2024.
		(450)	15.03.2024.
(210)	Z20230868A	(220)	15.09.2023.
		(181)	<b>15.09.2033.</b>
(732)	<b>KERN PHARMA, S.L.</b>		
(740)	c. Venus, 72-Polígono Industrial Colón II, 08228 Terrassa, ES		
(540)	PETOŠEVIĆ d.o.o., Zagreb, HR		

## REDILAX PRO

(511)	<b>5</b>	farmaceutski preparati; digestivna sredstva za farmaceutske potrebe; hranjivi dodaci za medicinske potrebe; probiotički pripravci za medicinske potrebe kao pomoć pri održavanju prirodne ravnoteže flore u probavnom sustavu; farmaceutski preparati za liječenje poremećaja probavnog sustava; farmaceutski pripravci i tvari za liječenje gastrointestinalnih bolesti; gastrointestinalni pripravci; sredstva za čišćenje (purgativi); antacidi; laksativi; prehrambena vlakna za pomoć probavi; farmaceutska sredstva koja utječu na probavne organe; lijekovi za crijevne poremećaje
-------	----------	---

(111)	<b>Z20230921</b>	(151)	08.03.2024.
		(450)	15.03.2024.
(210)	Z20230921A	(220)	27.09.2023.
		(181)	<b>27.09.2033.</b>
(732)	<b>BGP Products Operations GmbH</b>		
(740)	Turmstrasse 24, 6312 Steinhausen, CH		
(540)	ZMP IP d.o.o., Zagreb, HR		

## CORRECTIRON

(511)	<b>5</b>	farmaceutski pripravci i proizvodi; lijekovi; medicinski pripravci; dijetetski dodaci; dodaci prehrani
-------	----------	--

## RAZRED 6

(111)	<b>Z20230788</b>	(151)	01.03.2024.
		(450)	15.03.2024.
(210)	Z20230788A	(220)	22.08.2023.
		(181)	<b>22.08.2033.</b>
(732)	<b>Trinapower Co., Ltd.</b>		
	2 Tianhe Road. Xinbei District, Changzhou City, Jiangsu Province, CN		



(740) Igor Dlačić, Zagreb, HR  
(540)

Fujia

(591) crna  
(531) 27.05.01  
(511)

- 6** metalni konzolni nosač; podupirači od metala; metalni nosač cijevi; metalne spojnice za cijevi; krovni pokrivači od metala; metalna krovna ploča; krovne konstrukcije od metala; metalni krovovi sa ugrađenim fotonaponskim ćelijama; metalni okviri za građevinarstvo; metalne ograde za građevinske i montažne panele
- 9** fotonaponski inverteri; superkondenzatori za pohranu energije; elektrolizeri; oprema za proizvodnju fotonaponske energije; fotonaponski uređaji i oprema za proizvodnju solarne energije; fotonaponski paneli; fotonaponske ćelije; solarne ploče za proizvodnju električne energije; akumulatori, električni; solarne baterije
- 19** pločice za stakleni krov; staklena opeka; krovni pokrivači, nemetalni; krovništa, nemetalna, s ugrađenim fotonaponskim fotoćelijama; obloženo staklo; modificirano ravno staklo za gradnju; građevinsko staklo; sigurnosno staklo; laminirano ravno staklo; izolacijsko staklo za građevinarstvo

(111) **Z20230923** (151) 07.03.2024.  
(450) 15.03.2024.  
(210) Z20230923A (220) 27.09.2023.  
(181) **27.09.2033.**

(732) **Trinapower Co., Ltd**  
2 Tianhe Road, 213031 Xinbei District, Changzhou City, CN

(740) Igor Dlačić, Zagreb, HR  
(540)

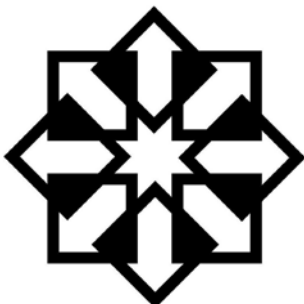
(531) 24.15.03; 24.15.08; 24.15.11; 24.15.15; 26.04.01; 26.04.07;  
26.04.09; 26.04.12

- (511) **6** metalni konzolni nosač; podupirači od metala; metalni nosač cijevi; metalne spojnice za cijevi; krovni pokrivači od metala; metalna krovna ploča; krovne konstrukcije od metala; metalni krovovi sa ugrađenim fotonaponskim ćelijama; metalni okviri za građevinarstvo; metalne ograde za građevinske i montažne panele
- 9** fotonaponski inverter; superkondenzatori za pohranu energije; elektrolizeri; oprema za proizvodnju fotonaponske energije; fotonaponski uređaji i oprema za proizvodnju solarne energije; fotonaponski paneli; fotonaponske ćelije; solarne ploče za proizvodnju električne energije; akumulatori, električni; solarne baterije
- 19** pločice za stakleni krov; staklena opeka; krovni pokrivači, nemetalni; krovništa, nemetalna, s ugrađenim fotonaponskim fotoćelijama; obloženo staklo; modificirano ravno staklo za gradnju; građevinsko staklo; sigurnosno staklo; laminirano ravno staklo; izolacijsko staklo za građevinarstvo

## RAZRED 9

(111) **Z20230552** (151) 27.02.2024.  
(450) 15.03.2024.  
(210) Z20230552A (220) 07.06.2023.  
(181) **07.06.2033.**

(732) **POSLOVNA INTELIGENCIJA d.o.o. za dizajn i implementaciju inteligentnih informacijskih sustava**  
Ulica Krste Pavletića 1, 10000 Zagreb, HR

(540)



(591) crvena, crna  
(531) 03.07.21; 03.07.24; 27.05.01; 27.05.07; 27.05.10; 29.01.01;  
29.01.08

- (511) **9** aplikacije za računalne programe koje se mogu preuzeti s interneta; čitači (informatika); memorije za računalna; monitori (računalna oprema); monitori (računalni programi); nosiva računala; nosivi monitori za prikazivanje videosadržaja; obrada podataka (uređaji za obradu podataka); pretražnici (sceneri) (informatika); prijenosna računala; računala; računalne softverske platforme, snimljene ili koje se može preuzimati s interneta; računalni programi (radni); računalni programi (snimljeni); računalni programi koji se mogu preuzeti; nijedan od prethodno navedenih proizvoda ne koristi se u području navodnjavanja, zalijevanja, korištenja vode, distribucije vode, opskrbe vodom, upravljanja vodom, hortikulture, poljoprivrede, uređenja krajobraza, ili uzgoja biljaka ili za korištenje u vezi s kontrolom, nadzorom, vođenjem, upravljanjem, automatizacijom ili analiziranjem sustava za navodnjavanje, sustava prskalice, navodnjavanja, korištenja vode, opskrbe vodom, distribucije vode, obrade vode, podataka o okolišu, ili uvjeta rasta biljaka
- 42** analiza računalnih sustava; cloud računarstvo; daljinski nadzor računalnih sustava; dupliranje informatičkih programa; instaliranje računalnih programa; iznajmljivanje informatičkih programa; izrada (koncipiranje) računalnih programa; konverzija informatičkog programa i podataka (nije fizička konverzija); konzultacije u svezi računalnih programa (softvera); platforma kao usluga (PaaS); pohrana elektroničkih podataka; praćenje računalnih sustava za otkrivanje nedozvoljenog pristupa ili povrede podataka; programiranje za računala; računalni programi (održavanje računalnih programa); računalni programi (softveri) (osuvremenjivanje računalnih programa); razvijanje računalnih platformi; razvoj softvera u okviru izdavanja softvera; savjetodavne usluge u vezi s računalnom tehnologijom; savjetovanje na području informacijske tehnologije (IT); softver kao usluga u oblaku (SaaS); spašavanje računalnih podataka; usluge enkripcije podataka; usluge informacijske tehnologije koje pružaju vanjski pružatelji usluga; usluge savjetovanja u području sigurnosti podataka; nijedna od prethodno navedenih usluga ne pruža se u području navodnjavanja, zalijevanja, korištenja vode, distribucije vode, opskrbe vodom, upravljanja vodom, hortikulture, poljoprivrede, uređenja krajobraza, ili uzgoja biljaka, ili za korištenje u vezi s kontrolom, nadzorom, vođenjem, upravljanjem, automatizacijom ili analiziranjem sustava za navodnjavanje, sustava prskalice, navodnjavanja, korištenja vode, opskrbe vodom, distribucije vode, obrade vode, podataka o okolišu, ili uvjeta rasta biljaka

(111) **Z20230585** (151) 29.02.2024.  
(450) 15.03.2024.  
(210) Z20230585A (220) 16.06.2023.  
(310) 40-2022-0231475 (320) 16.12.2022. (330) **16.12.2023.**

(732) **Kia Corporation** (181) **16.06.2033.**  
 12, Heolleung-ro, Seocho-gu, 06797 Seoul, KR  
 (740) Hraste & Partneri odvjetničko društvo d.o.o., Zagreb, HR  
 (540)



(531) 27.05.01; 27.05.09; 27.05.19  
 (511) **9** softver za instant plaćanja putem ugradbene audiovizualne navigacije u vozilima; audiovizualni navigacijski softver za instant plaćanja u vozilima; audiovizualna navigacija za vozila s funkcijom instant plaćanja u vozilima; ugrađeni programi za platforme instant plaćanja u vozilima; aplikacijski softver za pametne telefone za instant plaćanja u vozilima; daljinski upravljači za instant plaćanja u vozilima; računalni programi za instant plaćanja u vozilima; aplikacijski softver za pametne telefone za spajanja sa sustavom u vozilima; uređaj za obradu podataka za obradu elektroničkih plaćanja u vozilima; sigurnosni terminali za elektroničke transakcije u vozilima; aplikacijski softver za pametne telefone u vozilima koji omogućava upotrebu i instant plaćanja za gorivo, parkiranja, cestarine, hranu i piće, kao i u drugim trgovinama; računalni program u vozilima koji omogućava upotrebu i instant plaćanja za gorivo, parkiranja, cestarine, garažu, hranu i piće, kao i u drugim trgovinama; terminali za elektroničke transakcije ugrađeni u vozila; računalni programi za e-trgovinu

(111) **Z20230712** (151) 05.03.2024.  
 (450) 15.03.2024.  
 (210) Z20230712A (220) 24.07.2023.  
 (181) **24.07.2033.**  
 (732) **ADNET d.o.o.**  
 (540) Ulica Gustava Krkleca 28, 10000 Zagreb, HR



ADVANCED POWER SYSTEM MANAGEMENT  
 IN CONDITIONS OF UNCERTAINTY  
 ARISING FROM CLIMATE CHANGES

(591) crvena, crna, bijela  
 (531) 26.03.23; 27.05.01; 27.05.05; 27.05.11; 27.05.09; 27.05.10;  
 29.01.01  
 (511) **9** softver

(111) **Z20230887** (151) 05.03.2024.  
 (450) 15.03.2024.  
 (210) Z20230887A (220) 21.09.2023.  
 (181) **21.09.2033.**  
 (732) **Moberg d.o.o.**  
 (540) Strojarska cesta 20, 10000 Zagreb, HR



**RAVA**  
 Počinje od tebe

(531) 03.07.16; 03.07.24; 26.01.01; 26.01.15; 26.01.24; 27.05.01;  
 27.05.02; 27.05.09; 27.05.10; 29.01.08  
 (511) **9** znanstveni, istraživački, naučni, geodetski, fotografski, kinematografski, audiovizualni i optički aparati i instrumenti, kao i aparati i instrumenti za vaganje, mjerenje, signalizaciju, otkrivanje, testiranje, inspekciju, za pomoć (spašavanje) i za obuku; uređaji za računanje  
**35** oglašavanje

(111) **Z20230900** (151) 08.03.2024.  
 (450) 15.03.2024.  
 (210) Z20230900A (220) 22.09.2023.  
 (181) **22.09.2033.**

(732) **E-GLAS d.o.o.**  
 (740) Miroslava Krlježe 4, 51000 Rijeka, HR  
 (540) Anamari Laškarin, Rijeka, HR



(591) zelena, crvena, žuta, plava, bijela, narančasta, crna  
 (531) 27.05.01  
 (511) **9** računalni programi koji se mogu preuzeti; računalne softverske platforme, snimljene ili koje se može preuzimati sa interneta; računalni programi (radni)  
**42** softver kao usluga u oblaku (Saas)  
**44** logopedska terapija

## RAZRED 11

(111) **Z20230840** (151) 01.03.2024.  
 (450) 15.03.2024.  
 (210) Z20230840A (220) 04.09.2023.  
 (181) **04.09.2033.**  
 (732) **Volim Ljuto j.d.o.o.**  
 (540) Gajeva 37, 10297 Jakovlje, HR



(591) zelena, crvena, smeđa, tamno crvena, bijela  
 (531) 13.03.07; 01.15.05; 06.07.25; 07.03.25; 27.05.01; 27.05.05;  
 27.05.17; 26.05.01; 26.05.19; 26.05.18  
 (511) **11** roštilji; roštilj ploče; roštilj tave; plinski roštilji; električni roštilji; roštilj na ugljen; roštilji za meso; roštilji na ugljen; upaljači za roštilje; naprave za paljenje roštilja; uređaji za pripremanje roštilja; roštilji, električni  
**30** roštilj sos; umak za roštilj; umak [jestiv]; čili umak; sojin umak; koncentrirani umak; pikantni umak; worchester umak; ljuti umak  
**43** restorani brze hrane; catering u restoranima brze hrane; usluge restorana; catering; usluge cateringa; usluge mobilnog cateringa; usluge cateringa u vanjskom prostoru; usluge cateringa za pružanje hrane; usluge cateringa za poslovne svrhe; usluge pokretnih restorana

## RAZRED 16

(111)	<b>Z20230691</b>	(151)	01.03.2024.
		(450)	15.03.2024.
(210)	Z20230691A	(220)	19.07.2023.
		(181)	<b>19.07.2033.</b>

(732) **Modepack d.o.o.**  
Ulica Fausta Vrančića 33, 10410 Velika Gorica, HR

(540)



# MODEPACK

THE WHOLE PACKAGE

(591) tamno zelena  
(531) 15.01.13; 19.19; 26.01.05; 05.05.19; 05.05.20; 01.15.23;  
27.05.01; 27.05.10; 29.01.03  
(511) **16** papirna ambalaža  
**17** vrećice od gume za pakiranje  
**39** pakiranje proizvoda  
**42** dizajn proizvoda

(111)	<b>Z20230715</b>	(151)	01.03.2024.
		(450)	15.03.2024.
(210)	Z20230715A	(220)	24.07.2023.
		(181)	<b>24.07.2033.</b>

(732) **Modepack d.o.o.**  
Ulica Fausta Vrančića 33, 10410 Velika Gorica, HR

(540)



(591) tamno zelena  
(531) 24.05.01; 26.02.19; 26.02.01; 27.05.01; 27.05.05; 29.01.03;  
29.01.11  
(511) **16** ambalaža (papir za ambalažu); ambalaža [za oblaganje i punjenje] od papira ili kartona; pakiranje hrane (folije od papira ili plastike za održavanje vlage, za pakiranje hrane); vrećice [omotnice, đepovi] od papira ili plastike za ambalažu; vrećice, papirate  
**17** ambalaža [gumeni ili plastični materijali za ispunu pri ambalažiranju]

(111)	<b>Z20230843</b>	(151)	07.03.2024.
		(450)	15.03.2024.
(210)	Z20230843A	(220)	06.09.2023.
		(181)	<b>06.09.2033.</b>

(732) **HP - Hrvatska pošta d.d.**  
Jurišićeva ulica 13, 10000 Zagreb, HR

(540)



# ARTISTIC

(591) crna  
(531) 26.03.01; 26.01.01; 26.01.03; 26.01.19; 27.05.21; 27.05.17  
(511) **16** bojice; flomasteri u boji; glina za modeliranje; grafitne olovke u boji; gumice za brisanje; instrumenti za crtanje; kemijske gel olovke; kemijske olovke u boji; kistovi; kompleti boja za umjetnost i zanatstvo; kreda u boji; ljepljivo i ljepljiva sredstva za uredsku ili kućansku uporabu; ljepljiva traka; ljepljiva traka za uredske svrhe; markeri s bojom; mine za

tehničke olovke; naprava za rezanje papira (uredska oprema); palete za vodene boje; paste; pernice; pribor za crtanje (set); samoljepljivi blokovi; šiljila za olovke; spajalice za papir; tehničke olovke; uredski pribor; uredski strojevi; vodene boje (gotovo slikanje)

**35** distribucija letaka; distribucija oglasnog, marketinškog i promotivnog materijala; distribucija promidžbenih materijala, odnosno, letaka, prospekata, brošura, uzoraka, posebno za katalošku prodaju na veliku udaljenost izvan granica ili u zemlji; distribucija reklamnih materijala; distribucija reklamnog materijala putem pošte; distribucija reklamnog materijala za druge putem online komunikacijske mreže na internetu; istraživanje tržišta; istraživanje tržišta i marketinško istraživanje; izložbe (organiziranje -) u trgovačke svrhe; iznajmljivanje oglasnog prostora; iznajmljivanje oglasnog prostora na internetu; iznajmljivanje prodajnih štandova; iznajmljivanje reklamnih prostora; iznajmljivanje reklamnih panoa [reklamnih ploča]; iznajmljivanje reklamnog prostora na internetu; izravno oglašavanje putem pošte; izvođenje, pripremanje i organiziranje trgovačkih priredbi i trgovačkih sajmova u komercijalne i reklamne svrhe; marketing; novine (usluge pretplate novina) za treće osobe; objavljivanje promidžbenih tekstova; oglašavanje vezano uz transport i dostavu; online oglašavanje na računalnim mrežama; organiziranje, izvršavanje i nadziranje programa potrošačke vjernosti; posredovanje u oglašavanju; posredovanje u trgovinskim poslovima za treće osobe; pribavljanje prostora na web stranicama za oglašavanje robe i usluga; pripremanje i postavljanje reklama; pripremanje popisa poštanskih adresa za usluge izravnog oglašavanja putem pošte [osim prodaje]; provođenje ispitivanja javnog mnijenja; pružanje oglasnog prostora, vremena i usluge oglasnih medija; pružanje prostora na internetskim stranicama za oglašavanje robe i usluga; razdioba promidžbenih materijala putem pošte; razvrstavanje, rukovanje i prijem pošte; reklamiranje putem pošte; reklamna pošta; reklamni oglasi (širenje reklamnih oglasa); sakupljanje statističkih podataka vezanih uz oglašavanje; televizijsko reklamiranje; tisak (praćenje tiska); umnožavanje dokumenata; upravljanje poticajnim, promotivnim ili programima vjernosti korisnika; usluge izravnog oglašavanja putem pošte; usluge marketinškog istraživanja; usluge obrade podataka; usluge odnosa s javnošću; usluge oglašavanja i marketinga; usluge oglašavanja izravnom poštom koje pružaju poštanski uredi; usluge oglašavanja, marketinga i promidžbe; usluge oglašavanja, marketinga i promotivnog savjetovanja i podrške; usluge poslovne administracije; usluge poslovne analize, istraživanja i poslovnih informacija; usluge poslovne pomoći, upravljanja i administracije; usluge poslovnih savjetovanja; usluge poslovnog upravljanja; usluge posredovanja u trgovini; usluge programa vjernosti, motivacije i bonusa; usluge reprodukcije dokumenata

**38** dostava poruka pomoću elektroničkog prijenosa; ponuda elektroničkog poštanskog sandučića; poštanske usluge putem interneta i drugih komunikacijskih mreža; prikupljanje i dostavljanje poruka putem elektroničke pošte; pružanje usluga e-pošte; usluge e-pošte i poštanskog sandučića; usluge elektroničke komunikacije za pripremanje financijskih podataka; usluge mobilne telekomunikacije; usluge telekomunikacije između financijskih institucija

**39** distribucija pošiljaka; dostava pošiljaka; dostavljačke usluge [prijevoz pošte ili robe]; organiziranje preuzimanja pošiljaka; poštanske usluge; usluge dostave pošiljaka; usluge praćenja i sljedećih pisama i pošiljaka; usluge primanja pošiljaka

**40** tiskanje na majice; tiskanje reklamnog materijala; tiskanje tekstila

(111)	<b>Z20230844</b>	(151)	07.03.2024.
		(450)	15.03.2024.
(210)	Z20230844A	(220)	06.09.2023.
		(181)	<b>06.09.2033.</b>

(732) **HP - Hrvatska pošta d.d.**  
Jurišićeva ulica 13, 10000 Zagreb, HR

(540)



(591) crna, bijela, žuta, crvena, plava  
 (531) 26.03.01; 26.01.01; 26.01.03; 26.01.19; 27.05.21; 27.05.17;  
 27.05.24

(511) **16** bojice; flomasteri u boji; glina za modeliranje; grafitne olovke u boji; gumice za brisanje; instrumenti za crtanje; kemijske gel olovke; kemijske olovke; kemijske olovke u boji; kistovi; kompleti boja za umjetnost i zanatstvo; kreda u boji; ljepilo i ljepiliva sredstva za uredsku ili kućansku uporabu; ljepiliva traka; ljepiliva traka za uredske svrhe; markeri s bojom; mine za tehničke olovke; naprava za rezanje papira (uredska oprema); palete za vodene boje; paste; pernice; pribor za crtanje (set); samoljepljivi blokovi; šiljila za olovke; spajalice za papir; tehničke olovke; uredski pribor; uredski strojevi; vodene boje (gotovo slikanje)

**35** distribucija letaka; distribucija oglasnog, marketinškog i promotivnog materijala; distribucija promidžbenih materijala, odnosno, letaka, prospekata, brošura, uzoraka, posebno za katalošku prodaju na veliku udaljenost izvan granica ili u zemlji; distribucija reklamnih materijala; distribucija reklamnog materijala putem pošte; distribucija reklamnog materijala za druge putem online komunikacijske mreže na internetu; istraživanje tržišta; istraživanje tržišta i marketinško istraživanje; izložbe (organiziranje -) u trgovačke svrhe; iznajmljivanje oglasnog prostora; iznajmljivanje oglasnog prostora na internetu; iznajmljivanje prodajnih štandova; iznajmljivanje reklamnih prostora; iznajmljivanje reklamnih panoa [reklamnih ploča]; iznajmljivanje reklamnog prostora na internetu; izravno oglašavanje putem pošte; izvođenje, pripremanje i organiziranje trgovačkih priredbi i trgovačkih sajmova u komercijalne i reklamne svrhe; marketing; novine (usluge pretplate novina) za treće osobe; objavljivanje promidžbenih tekstova; oglašavanje vezano uz transport i dostavu; online oglašavanje na računalnim mrežama; organiziranje, izvršavanje i nadziranje programa potrošačke vjernosti; posredovanje u oglašavanju; posredovanje u trgovinskim poslovima za treće osobe; pribavljanje prostora na web stranicama za oglašavanje robe i usluga; pripremanje i postavljanje reklama; pripremanje popisa poštanskih adresa za usluge izravnog oglašavanja putem pošte [osim prodaje]; provođenje ispitivanja javnog mnijenja; pružanje oglasnog prostora, vremena i usluge oglasnih medija; pružanje prostora na internetskim stranicama za oglašavanje robe i usluga; razdioba promidžbenih materijala putem pošte; razvrstavanje, rukovanje i prijem pošte; reklamiranje putem pošte; reklamna pošta; reklamni oglasi (širenje reklamnih oglasa); sakupljanje statističkih podataka vezanih uz oglašavanje; televizijsko reklamiranje; tisak (praćenje tiska); umnožavanje dokumenata; upravljanje poticajnim, promotivnim ili programima vjernosti korisnika; usluge izravnog oglašavanja putem pošte; usluge marketinškog istraživanja; usluge obrade podataka; usluge odnosa s javnošću; usluge oglašavanja i marketinga; usluge oglašavanja izravnom poštom koje pružaju poštanski uredi; usluge oglašavanja, marketinga i promidžbe; usluge oglašavanja, marketinga i promotivnog savjetovanja i podrške; usluge poslovne administracije; usluge poslovne analize, istraživanja i poslovnih informacija; usluge poslovne pomoći, upravljanja i administracije; usluge poslovnih savjetovanja; usluge poslovnog upravljanja; usluge posredovanja u trgovini; usluge programa vjernosti, motivacije i bonusa; usluge reprodukcije dokumenata

**38** dostava poruka pomoću elektroničkog prijenosa; ponuda elektroničkog poštanskog sandučića; poštanske usluge putem interneta i drugih komunikacijskih mreža; prikupljanje i dostavljanje poruka putem elektroničke pošte; pružanje usluga e-pošte; usluge e-pošte i poštanskog sandučića; usluge elektroničke komunikacije za pripremanje financijskih podataka; usluge mobilne telekomunikacije; usluge telekomunikacije između financijskih institucija

**39** distribucija pošiljaka; dostava pošiljaka; dostavljačke usluge [prijevoz pošte ili robe]; organiziranje preuzimanja pošiljaka; poštanske usluge; usluge dostave pošiljaka; usluge praćenja i slijeđenja pisama i pošiljaka; usluge primanja pošiljaka  
**40** tiskanje na majice; tiskanje reklamnog materijala; tiskanje tekstila

(111) **Z20230915** (151) 07.03.2024.  
 (450) 15.03.2024.  
 (210) Z20230915A (220) 26.09.2023.  
 (732) **HRVATSKI GOLF SAVEZ** (181) **26.09.2033.**  
 Mihanovićeve ulica 1, 10000 Zagreb, HR

(540)



(591) bijela, plava, zelena, siva  
 (531) 27.05.01

(511) **16** ambalaža (papir za ambalažu); ambalaža (za oblaganje i punjenje) od papira i kartona; bilježnice; blokovi (povezani listovi papira); blokovi za crtanje; brošure; časopisi (periodike); časopisi (revije); čestitke; fascikli; kalendari; klaseri (uređaji pribor); knjige; košuljice za spise; letci; listovi (papirni proizvodi); naljepnice (ne od tkanine); novine; obavijesti (papirni proizvodi); obrasci; okružnice; omotnice (papirni proizvodi); papir (pergament papir); papir; papir za kopiranje; pečati; pečati (žigovi); pisma (papir za pisma); plakati (poster); plakati, papirni ili kartonski; podlošci za boce, papirni; podlošci za pivske čaše; precrti (kopije); prospekti; publikacije; registri (knjige); upijači (bunjače); vrećice, papirne; zastavice od papira  
**18** futrole za ključeve; kišobrani; kovčezi od kože i od kože i kartona; kovčezi, ručni; lisnice; navlake za kišobrane; novčanici za kreditne kartice; putni kovčezi; putovanje (torbe za putovanje; ručke za kišobrane; ručke za kovčege; suncobrani; školske torbe; torbe (ručne torbe); torbe (sportske torbe); torbe na kotačićima; torbe za spise [aktovke]; torbe - navlake za odijela [za putovanja]  
**21** bombonjere; čaše (velike šalice); čaše za piće; čaše za pivo; kalupi za pravljenje kockica leda; kristalni proizvodi; podlošci za čaše; podlošci za posude s jelom (stolni pribor); poslužavnici; predmeti od kineskog porculana; pribor za jelo (posuđe); servisi za čaj; servisi za kavu (stolno posuđe); sportske bočice za vodu; tanjuri (posuđe); vaze (posuđe)  
**24** jastučnice; plahte; popluni; zastave (barjaci); zastavice, nepapirne  
**25** čarape; džemper; džersej (odjevni predmet); hlače; kabanice; kape za glavu; konfekcijska odjeća; košulje; košulje s kratkim rukavima; kratke hlače; kratki kaputi (sakoi); kravate; umjetničke kravate; livreve (odore); odjeća\*; odjevni predmeti\*; parke (kratki sportski kaputi s kapuljačom); prsluci; sportska obuća\*; sportske cipele\*; šeširi; tee-shirts (majice); viziri (pokrivala za glavu); vrpce za glavu (odjevni predmeti)  
**27** prekrivači podova od vinila; prekrivači za podove; travnjaci, umjetni  
**28** igraće karte; kolica za torbe za golf; rukavice za golf; štاپови za golf; torbe za štاپove za golf, sa ili bez kotačića  
**41** golf (stavljanje na raspolaganje igrališta za golf); iznajmljivanje opreme za igranje; iznajmljivanje sportske opreme; iznajmljivanje sportskih terena; kampovi za sportsko usavršavanje; organiziranje sportskih natjecanja; praktična obuka (demonstriranje); profesionalna orijentacija (savjeti u svezi odgoja ili osposobljavanja); razonoda; slobodno vrijeme (usluge za ispunjavanje slobodnog vremena); sportska oprema

(stavljanje na raspolaganje sportske opreme);  
tjelovježbe (fizička kultura); treniranje (tjelovježba)

(111)	<b>Z20230916</b>	(151)	07.03.2024.
		(450)	15.03.2024.
(210)	Z20230916A	(220)	26.09.2023.
		(181)	<b>26.09.2033.</b>
(732)	<b>HRVATSKI GOLF SAVEZ</b>		
(540)	Mihanovićeveca ulica 1, 10000 Zagreb, HR		



(591) bijela, plava, zelena, crvena, žuta, siva  
(531) 29.01.01

- (511) **16** ambalaža (papir za ambalažu); ambalaža (za oblaganje i punjenje) od papira i kartona; bilježnice; blokovi (povezani listovi papira); blokovi za crtanje; brošure; časopisi (periodike); časopisi (revije); čestitke; fascikli; kalendari; klaseri (uredajni pribor); knjige; košuljice za spise; letci; listovi (papirni proizvodi); naljepnice (ne od tkanine); novine; obavijesti (papirni proizvodi); obrasci; okružnice; omotnice (papirni proizvodi); papir (pergament papir); papir; papir za kopiranje; pečati; pečati (žigovi); pisma (papir za pisma); plakati (poster); plakati, papirni ili kartonski; podlošci za boce, papirni; podlošci za pivske čaše; precrti (kopije); prospekti; publikacije; registri (knjige); upijači (bugačice); vrećice, papirne; zastavice od papira
- 18** futrole za ključeve; kišobrani; kovčezi od kože i od kože i kartona; kovčezi, ručni; lisnice; navlake za kišobrane; novčanici za kreditne kartice; putni kovčezi; putovanje (torbe za putovanje; ručke za kišobrane; ručke za kovčege; suncobrani; školske torbe; torbe (ručne torbe); torbe (sportske torbe); torbe na kotačićima; torbe za spise [aktovke]; torbe - navlake za odijela [za putovanja])
- 21** bombonjere; čaše (velike šalice); čaše za piće; čaše za pivo; kalupi za pravljenje kockica leda; kristalni proizvodi; podlošci za čaše; podlošci za posude s jelom (stolni pribor); poslužavnici; predmeti od kineskog porculana; pribor za jelo (posuđe); servisi za čaj; servisi za kavu (stolno posuđe); sportske bočice za vodu; tanjuri (posuđe); vaze (posuđe)
- 24** jastučnice; plahte; popluni; zastave (barjaci); zastavice, nepapirne
- 25** čarape; džemper; džersei (odjevni predmet); hlače; kabanice; kape za glavu; konfekcijska odjeća; košulje; košulje s kratkim rukavima; kratke hlače; kratki kaputi (sakoi); kravate; umjetničke kravate; livreve (odore); odjeća\*; odjevni predmeti\*; parke (kratki sportski kaputi s kapuljačom); prsluci; sportska obuća\*; sportske cipele\*; šeširi; tee-shirts (majice); viziri (pokrivala za glavu); vrpce za glavu (odjevni predmeti)
- 27** prekrivači podova od vinila; prekrivači za podove; travnjaci, umjetni
- 28** igrače karte; kolica za torbe za golf; rukavice za golf; štapovi za golf; torbe za štapove za golf, sa ili bez kotačića
- 41** golf (stavljanje na raspolaganje igrališta za golf); iznajmljivanje opreme za igranje; iznajmljivanje sportske opreme; iznajmljivanje sportskih terena; kampovi za sportsko usavršavanje; organiziranje sportskih natjecanja; praktična obuka (demonstriranje); profesionalna orijentacija (savjeti u svezi odgoja ili osposobljavanja); razonoda; slobodno vrijeme (usluge za ispunjavanje slobodnog vremena); sportska oprema (stavljanje na raspolaganje sportske opreme); tjelovježbe (fizička kultura); treniranje (tjelovježba)

## RAZRED 19

(111)	<b>Z20230629</b>	(151)	29.02.2024.
		(450)	15.03.2024.
(210)	Z20230629A	(220)	28.06.2023.
		(181)	<b>28.06.2033.</b>
(732)	<b>Mladen Percan</b>		
(740)	Medulinska cesta 18D, 52100 Pula, HR		
(540)	Aleksandar Puh, Pula, HR		

## Kamen Percan

- (511) **19** građevinski i konstrukcijski materijali i elementi, ne od metala; kipovi i umjetnička djela od materijala kao što su kamen, beton i mramor, obuhvaćeni ovim razredom; kamen, glina i minerali; kamena ili drvena sitnež; strukture i prijenosne konstrukcije, ne od metala; kamen; kamenje; pješčenjak [kamen]; zidni kamen; rekonstruirani kamen; silicijski kamen; keramički kamen; građevinski kamen; kamen lomljenac; usitnjeni kamen; prirodni kamen; kameni škriljevac; kameni spomenici; kameni ukrasi; kamene skulpture; kameni kipovi; kameni fenjeri [vrtni kameni ukrasi]; obrađeni prirodni kamen; ukrasi od kamena; biste od kamena; spomenici od kamena; skulpture od kamena; predmeti isklesani iz kamena; spomeničke ploče od kamena; kameni furniri [građevinski materijali]; stupići od prirodnog kamena; stupići od umjetnog kamena; pločice od prirodnog kamena; ploče od prirodnog kamena; suhe završne obrade za kamen; ukrasi od kamena za bazene; kameni, betonski ili mramorni pokali; kamene skulpture
- 21** kamene posude; kamene podne vaze za cvijeće
- 40** iznajmljivanje opreme za obrađivanje i preinačavanje materijala, proizvodnju energije i izrađivanje po mjeri; mljevenje kamena; rezbarenje kamena; sastavljanje proizvoda za klijente

## RAZRED 20

(111)	<b>Z20230852</b>	(151)	27.02.2024.
		(450)	15.03.2024.
(210)	Z20230852A	(220)	08.09.2023.
		(181)	<b>08.09.2033.</b>
(732)	<b>Anton Stepanchenko</b>		
(540)	Smoković 282, Smoković, 23222 Zemunik Donji, HR		



- (591) žuta, crna  
(531) 03.07.21; 03.07.24; 27.03.01; 27.03.03; 27.05.01; 27.05.05; 27.05.09; 27.05.10; 29.01.02; 29.01.08
- (511) **20** figurice od drva, voska, gipsa ili od plastike  
**28** ukrasi za božićna drvca (osim lampica, svijeća i slatkiša)

## RAZRED 25

(111)	<b>Z20230797</b>	(151)	27.02.2024.
		(450)	15.03.2024.
(210)	Z20230797A	(220)	23.08.2023.
		(181)	<b>23.08.2033.</b>

(732) **CARLSBERG CROATIA društvo s ograničenom odgovornošću**  
Ulica Danica 3, 48000 Koprivnica, HR  
(740) Sven Barac, Zagreb, HR  
(540)

# PAN. PONOSNI POKROVITELJ REKREATIVACA

(511) **25** čarape; dijelovi odjeće, obuće i pokrivala za glavu; jakne; kostimi; kupače gaćice; kupači kostimi; maska za lice [odjeća]; nogometne majice; nogometni dresovi; obuća; odjeća; rukavice; šalovi; skafanderi; sportska obuća; sportska odjeća; tenisice; trake za glavu  
**32** bezalkoholna pića; bezalkoholna pića s okusom piva; bezalkoholno pivo; ekstrakti hmelja za pripremu napitaka; ekstrakti hmelja za proizvodnju piva; kokteli na bazi piva; mošt; napici (Bezalkoholni -); niskoalkoholno pivo; pića na bazi piva; piva s okusima; pivo; pivo i bezalkoholno pivo; pivski mošt; radler; vode; sokovi  
**35** oglašavanje; marketing; promidžba; maloprodajne usluge vezane uz bezalkoholna pića i pivo; veleprodajne usluge vezane uz bezalkoholna pića i pivo; organiziranje događanja, izložbi, sajmovi i priredbi u komercijalne, promotivne i reklamne svrhe  
**39** ambalažiranje i usluge pakiranja; ambalažiranje proizvoda; dostava i skladištenje robe; informativne usluge u svezi s skladištenjem; informativne usluge u svezi s prijevozom; isporuka [distribucija] robe; iznajmljivanje skladišta; najam vozila; otprema robe; otprema tereta; pakiranje i skladištenje robe; pakiranje proizvoda i robe; pakiranje tereta; preuzimanje, prijevoz i dostava paketa i robe; prijevoz i skladištenje; prijevoz tereta; raščišćavanje [uklanjanje i prijevoz] otpada; skladištenje; umatanje robe; usluge u svezi s teretom; utovar i istovar robe; utovar tereta; zamatanje i pakiranje robe

(111) **Z20230798** (151) 27.02.2024.  
(450) 15.03.2024.  
(210) Z20230798A (220) 23.08.2023.  
(181) **23.08.2033.**  
(732) **CARLSBERG CROATIA društvo s ograničenom odgovornošću**  
Ulica Danica 3, 48000 Koprivnica, HR  
(740) Sven Barac, Zagreb, HR  
(540)



(591) zelena, tamno zelena, bijela  
(531) 27.05.01; 27.05.08; 27.05.09; 27.05.10; 27.05.11; 27.05.12; 27.05.15; 26.01.02; 26.01.12; 26.01.16; 26.01.18; 26.01.20; 29.01.03; 29.01.06

(511) **25** čarape; dijelovi odjeće, obuće i pokrivala za glavu; jakne; kostimi; kupače gaćice; kupači kostimi; maska za lice [odjeća]; nogometne majice; nogometni dresovi; obuća; odjeća; rukavice; šalovi; skafanderi; sportska obuća; sportska odjeća; tenisice; trake za glavu  
**32** bezalkoholna pića; bezalkoholna pića s okusom piva; bezalkoholno pivo; ekstrakti hmelja za pripremu napitaka; ekstrakti hmelja za proizvodnju piva; kokteli na bazi piva; mošt; napici (Bezalkoholni -); niskoalkoholno pivo; pića na bazi piva; piva s okusima;

pivo; pivo i bezalkoholno pivo; pivski mošt; radler; vode; sokovi

**35** oglašavanje; marketing; promidžba; maloprodajne usluge vezane uz bezalkoholna pića i pivo; veleprodajne usluge vezane uz bezalkoholna pića i pivo; organiziranje događanja, izložbi, sajmovi i priredbi u komercijalne, promotivne i reklamne svrhe  
**39** ambalažiranje i usluge pakiranja; ambalažiranje proizvoda; dostava i skladištenje robe; informativne usluge u svezi s skladištenjem; informativne usluge u svezi s prijevozom; isporuka [distribucija] robe; iznajmljivanje skladišta; najam vozila; otprema robe; otprema tereta; pakiranje i skladištenje robe; pakiranje proizvoda i robe; pakiranje tereta; preuzimanje, prijevoz i dostava paketa i robe; prijevoz i skladištenje; prijevoz tereta; raščišćavanje [uklanjanje i prijevoz] otpada; skladištenje; umatanje robe; usluge u svezi s teretom; utovar i istovar robe; utovar tereta; zamatanje i pakiranje robe

## RAZRED 28

(111) **Z20230872** (151) 08.03.2024.  
(450) 15.03.2024.  
(210) Z20230872A (220) 15.09.2023.  
(181) **15.09.2033.**  
(732) **TECHNOSMART j.d.o.o.**  
Tadije Smičiklasi 5C, 47000 Karlovac, HR  
(740) Odvjetničko društvo Ivković & Kruc j.t.d., Zagreb, HR  
(540)

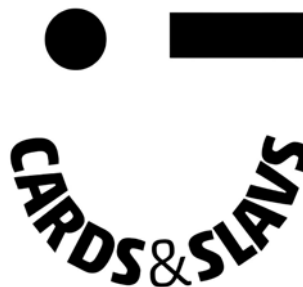

(591) crna  
(531) 29.01.08  
(511) **28** igre; društvene igre

(111) **Z20230873** (151) 08.03.2024.  
(450) 15.03.2024.  
(210) Z20230873A (220) 15.09.2023.  
(181) **15.09.2033.**  
(732) **TECHNOSMART j.d.o.o.**  
Tadije Smičiklasi 5C, 47000 Karlovac, HR  
(740) Odvjetničko društvo Ivković & Kruc j.t.d., Zagreb, HR  
(540)



(591) bijela  
(531) 29.01.08  
(511) **28** igre; društvene igre

(111) **Z20230874** (151) 08.03.2024.  
(450) 15.03.2024.  
(210) Z20230874A (220) 15.09.2023.  
(181) **15.09.2033.**  
(732) **TECHNOSMART j.d.o.o.**  
Tadije Smičiklasi 5C, 47000 Karlovac, HR  
(740) Odvjetničko društvo Ivković & Kruc j.t.d., Zagreb, HR

(540)

## Cards and Slavs

(511) 28 igre; društvene igre

### RAZRED 29

(111) **Z20230757** (151) 07.03.2024.  
(450) 15.03.2024.  
(210) Z20230757A (220) 08.08.2023.  
(181) 08.08.2023.

(732) **ORADA ADRIATIC d.o.o.**  
Turion 22, 51557 Cres, HR  
(740) Anamari Laškarin, Rijeka, HR  
(540)



(591) crna, plava, žuta  
(531) 03.09.01; 03.09.24; 24.09.02; 24.09.03; 24.09.09; 27.05.01;  
27.05.10; 27.05.24; 29.01.02; 29.01.04; 29.01.08

(511) 29 dagnje za jelo, nežive; riblji fileti; ljuskari (rakovi) neživi;  
riba; riba usoljena; školjke, nežive; riba konzervirana;  
konzerve riblje; marinirana riba; riba očišćena

31 proizvodi uzgoja

39 ambalažiranje proizvoda; isporuka proizvoda;  
skladištenje

(111) **Z20230778** (151) 01.03.2024.  
(450) 15.03.2024.  
(210) Z20230778A (220) 17.08.2023.  
(181) 17.08.2023.

(732) **CLARUM d.o.o.**  
Ulica I industrijski odvojak 9, 35400 Nova Gradiška, HR  
(540)

## CLARUM

(511) 29 meso; riba; perad i divljač; mesni ekstrakti;  
konzervirano, sušeno i kuhano voće i povrće; hladetina  
(želei); džemovi; kompoti; jaja; mlijeko i mliječni  
proizvodi; jestiva ulja i masti

30 kava; čaj; kakao; šećer; riža; tapioka; sago; nadomjesci  
kave; brašno i proizvodi od žitarica; kruh; kolači;  
slastice; bomboni; sladoled; med; sirup od melase;  
kvasac; prašak za dizanje; sol; slačica (senf); ocat;  
umaci (začini); mirodije; led za hlađenje

(111) **Z20230856** (151) 29.02.2024.  
(450) 15.03.2024.  
(210) Z20230856A (220) 11.09.2023.  
(181) 11.09.2023.

(732) **PIK VRBOVEC plus d.o.o.**  
Zagrebačka 148, 10340 Vrbovec, HR  
(740) Odvjetničko društvo VUKINA & PARTNERI d.o.o., Zagreb, HR  
(540)

## BOOM BURGER

(511) 29 meso i mesni proizvodi; pljeskavice; mesni proizvodi u  
obliku burgera

(111) **Z20230857** (151) 29.02.2024.  
(450) 15.03.2024.  
(210) Z20230857A (220) 11.09.2023.  
(181) 11.09.2023.

(732) **PIK VRBOVEC plus d.o.o.**  
Zagrebačka 148, 10340 Vrbovec, HR  
(740) Odvjetničko društvo VUKINA & PARTNERI d.o.o., Zagreb, HR  
(540)



(591) bijela, crna, crvena, koraljno crvena  
(531) 03.04.01; 03.04.13; 03.04.04; 21.01.01; 27.05.17; 27.05.24;  
26.04.02; 26.04.05

(511) 29 meso i mesni proizvodi; pljeskavice; mesni proizvodi u  
obliku burgera

(111) **Z20230858** (151) 29.02.2024.  
(450) 15.03.2024.  
(210) Z20230858A (220) 11.09.2023.  
(181) 11.09.2023.

(732) **PIK VRBOVEC plus d.o.o.**  
Zagrebačka 148, 10340 Vrbovec, HR  
(740) Odvjetničko društvo VUKINA & PARTNERI d.o.o., Zagreb, HR  
(540)



(591) svijetlo smeđa, zlatna, bež, smeđa bež, crvena, bijela  
(531) 25.01.15; 25.01.19; 21.01.01; 21.01.04; 27.05.01; 27.05.02;  
27.05.04; 27.05.08; 27.05.09; 27.05.10; 29.01.01; 29.01.02;  
29.01.06; 29.01.07

(511) 29 meso i mesni proizvodi; gotova jela napravljena od  
mesa (meso prevladava); svinjska koljenica; svinjski  
kottleti; svinjska leđa; svinjski odresci; obrađeni mesni  
proizvodi; pripremljeno meso; mesni ekstrakti; mesni  
naresci; hladetina (želei); jestiva ulja i masti

### RAZRED 30

(111) **Z20230845** (151) 29.02.2024.  
(450) 15.03.2024.  
(210) Z20230845A (220) 07.09.2023.  
(181) 07.09.2023.

(732) **PEKARNA STARI ZAGREB d.o.o.**  
Dankovečka ulica 104, 10040 Zagreb (Grad Zagreb), HR  
(740) Dolores Svitlanović, Zagreb-Dubrava, HR  
(540)

## PEKARNA STARI ZAGREB

(511) 30 prerađene žitarice, škrobovi i njihovi proizvodi,  
pripravci za pečenje i kvasci; aromatizirani šećerni  
konditorski proizvodi; aromatizirani žele u kristalima za

pripremu slastica od želea; bademi u čokoladi; bezglutenski pekarski proizvodi; biljno-medne pastile [slatkiši]; bobičasto voće preliveno čokoladom; čips od krumpira prekriven čokoladom; čokolada; čokolada s alkoholom; čokolada s mješuricama zraka; čokolada za konditorske proizvode i kruh; čokoladne dekoracije za kolače; čokoladne kore koje sadrže mljevena zrna kave; čokoladne kreme; čokoladne mrvice; čokoladni deserti; čokoladni konditorski proizvodi koji imaju okus pralina; čokoladni marcipan; čokoladni namazi; čokoladni namazi s orašastim plodovima; čokoladni namazi za kruh; crumble [britanski kolač od voća i žitarica]; desertni moussevi [slastičarski proizvodi]; desertni nabujci; čokoladni orašasti plodovi; čokoladni ukrasi za kolače; čokoladni umak; čokoladni vafli; čokoladni zečici; gotovi deserti [konditorski proizvodi]; gotovi deserti [na bazi čokolade]; gotovi pudinzi; graham krekeri; grickalice koje se uglavnom sastoje od slatkiša; halva; hrana koja sadržava kakao [kao glavni sastojak]; hrana koja sadržava čokoladu [kao glavni sastojak]; hrana na bazi kakaa; imitacija kreme od vanilije; imitacija čokolade; instant desertni pudinzi; jestivi papir; jestivi papirnati vafli; kanapei [mali slani zalogaji]; kapljice od karamela i maslaca; kikiriki konditorski proizvod; konditorski proizvodi (nemedicinski); konditorski proizvodi koji sadrže džem; konditorski proizvodi koji sadrže žele; konditorski proizvodi na bazi naranče; konditorski proizvodi od kuhanog šećera; konditorski proizvodi od orašćica; konditorski čips na bazi kakaa; imitacija kreme od vanilije; konditorski proizvodi od leda; konditorski proizvodi preliveni čokoladom; konditorski proizvodi s krumpirovim brašnom; konditorski proizvodi s okusom metvice (nemedicinski -); konditorski proizvodi s okusom sladića; konditorski proizvodi s okusom slatkog korijena; konditorski proizvodi s okusom čokolade; konditorski proizvodi s tekućim alkoholnim punjenjem; konditorski proizvodi s tekućim voćnim punjenjem; konditorski proizvodi s vinskim punjenjem; konditorski proizvodi za ukrašavanje božićnih drvca; konditorski sladoledi; kore za pitu od krekeru graham; krekeri; kruh; krekeri [jestivi]; krekeri s okusom voća; kreme na bazi kakaa u obliku namaza; kreme od jaja [pečene slastice]; kreme od jaja, prelivene s karamelnim sirupom; kroasani; krokant od kikirikija; kuglice zobi sa sušenim voćem; kuhani konditorski proizvodi; kukuruzni krekeri s aromom sira; ledena pića na bazi kakaa; ledena pića na bazi čokolade; ledeni konditorski proizvodi; ledeni slatkiši; lješnjaci prekriveni čokoladom; makadamia orašćici obloženi čokoladom; marcipan; marshmallow preljev; meringue [slastica od tučenog bjelanceta i šećera]; mješavina za kheer (indijski puding od riže); mješavina za vruću čokoladu; mliječna krema nizozemskog podrijetla [vla]; mliječni konditorski proizvodi; mousse pjena (slatka); moussevi [slastice]; musli deserti; namaz za sendvič od čokolade i orašćica; namazi na bazi čokolade; namazi na bazi kreme od nugata; nemedicinska čokolada; nemedicinski konditorski proizvodi kao dio kalorijski kontrolirane dijetle; nemedicinski konditorski proizvodi od brašna; nemedicinski konditorski proizvodi od brašna koji sadržavaju imitaciju čokolade; nemedicinski konditorski proizvodi od brašna koji sadrže čokoladu; nemedicinski konditorski proizvodi od brašna prekriveni čokoladom; nemedicinski konditorski proizvodi od brašna premazani imitacijom čokolade; nemedicinski konditorski proizvodi od metvice; nemedicinski konditorski proizvodi s okusom mljeka; nemedicinski konditorski proizvodi s punjenjem od karamela; nemedicinski konditorski proizvodi sa čokoladom; nemedicinski konditorski proizvodi u obliku jaja; nemedicinski konditorski proizvodi u obliku želea; nemedicinski čokoladni konditorski proizvodi; nemedicinski konditorski proizvodi; nemedicinski konditorski proizvodi s mljekom; nugat; nugat pločice s preljevom od čokolade; orašasti plodovi obloženi čokoladom; pandoro (tradicionalni kolač iz verone); panetone [božićni talijanski kolač s grožđicama]; panetone [vrsta dizanog kolača s grožđicama]; papad [indijski tanki kruh]; papadum [indijski tanki kruh]; pavlova torte od lješnjaka; pavlova torte s okusom lješnjaka; peciva od lisnatog tijesta s čokoladom; peciva s džemom; pekarske slastice; pločice od žitarica i energetske pločice; pekarski proizvodi; pite od smrznutog jogurta; pjenice [slastice]; pletenice od prženog tijesta; pločice od prosa ili napuhane riže u šećeru (okoshi); popadoms - tanki indijski kruh; poppadoms - tanki indijski kruh; poppadum - hrskavi indijski kruh; praline od oblatni; preliveni orašćici [konditorski]; pripravci za izradu slatkiša; proizvodi na

bazi čokolade; puding desert na bazi riže; puding od kruha; puding od krupice; puding od riže; pudinzi; pudinzi kao deserti; pudinzi od riže; pudinzi od riže koji sadrže grožđice i muškati orašćici; riža na mljeku; rolnice sa cimetom; sastojci na bazi kakaa za konditorske proizvode; scones [britansko slatko pecivo s voćem]; šećerna vuna; šećerni proizvodi za ukrašavanje božićnih drvca; slastice, torte, pite i keksi; slatkiši (bomboni), čokoladice i guma za žvakanje; bademovi kolačići; baklava; bavarske kreme; bečke slastice od tijesta; biskvit kuhan na pari (fagao); biskviti s glazurom; božićni puding [tradicionalni engleski božićni desert]; brioshi; brownies [kolači od čokolade]; čajni kolačići s mliječnom čokoladom; čokoladne oblatne; čokoladne paste; čokoladne slastice; čokolada za preljeve; čokoladice punjene likerom; slani keksi; slani keksi od oblatni; slani krekeri; slastice s niskim udjelom ugljikohidrata; slastice u obliku pjenica; slastičarske kaplice za pečenje; slatke žele pločice od paste od mahunarki [yohkan]; slatkiši od badema; slatkiši s čokoladnim preljevom; šnenokle; soljeni keksi; sopapillas [prženo tijesto sa šećerom]; sopapillas [prženi kruh] - jelo iz južne amerike; sušeni ušećerani kolači od rižinog brašna (rakugan); tekući konditorski proizvodi; tijesto za kekse biscotti; tiramisu; turski rahat lokum; turski rahat lokum preliven čokoladom; ukrasi za božićna drvca [jestivi]; uštipci s jabukom; vafli; vafli s čokoladnim preljevom; štipci od tijesta prženi u dubokom ulju (youtiao); varenci; varenci [pudinzi]; voće s preljevom od čokolade; voćni želei [konditorski proizvod]; zamjene za marcipan; zamjene za čokoladu; zamrznuti konditorski proizvodi; zamrznuti konditorski proizvodi koji sadržavaju sladoled; zamrznuti konditorski proizvodi na štipiću; zamrznuti mliječni konditorski proizvodi; zrna kakaa; zrna kave prelivena šećerom; želei (voćni -) [slatkiši]; žuti šećer

43 opskrba hrane i pića u pekarama

(111)	<b>Z20230895</b>	(151)	01.03.2024.
		(450)	15.03.2024.
(210)	Z20230895A	(220)	22.09.2023.
		(181)	<b>22.09.2033.</b>
(732)	<b>BOBIS d.o.o.</b>		
	Matoševa 50, 21210 Solin, HR		
(540)			

## HAJDUČKI KRUH

(511)	<b>30</b> beskvasni kruh; beskvasni kruh tanko narezan; čokolada za konditorske proizvode i kruh; čokoladni namazi za kruh; danski kruh; djelomično pečeni kruh; francuski kruh [baguette]; grickalice koje se uglavnom sastoje od kruha; integralni kruh; integralni kruh - crni kruh; koncentrat za kruh; kore od kruha punjene voćem; kruh; kruh aromatiziran začinicima; kruh bez glutena; kruh i peciva; kruh nan (indijski kruh); kruh od slada; kruh od slada s voćem; kruh od više vrsta žitarica; kruh pripremljen na pari; kruh s češnjakom; kruh s grožđicama; kruh s malo soli; kruh s natrijevim karbonatom; kruh sa slatkim crvenim grahamom; kruh sa sojinim zrnom; matzo [beskvasni kruh]; mekana peciva [kruh]; mješavina za sladni kruh; mješavine za integralni kruh; mješavine za kruh; mješavine za pripremu kruha; mješavine za punjenja na bazi kruha; mješavine za punjenje koje sadržavaju kruh; mornarski kruh; nefermentirani kruh; papad [indijski tanki kruh]; papadum [indijski tanki kruh]; pečene kukuruzne okruglice [kruh]; pita [arapski kruh]; plosnati kruh; plosnati kruh na bazi krumpira; pohani kruh; polu pečeni kruh; popadoms - tanki indijski kruh; poppadoms - tanki indijski kruh; poppadum - hrskavi indijski kruh; pripravci na bazi žitarica za poboljšanje kruha; puding od kruha; punjeni francuski kruh; raženi kruh; smjesa za kukuruzni kruh; smotuljak za sendvič [kruh]; sopapillas [prženi kruh] - jelo iz Južne Amerike; svježi kruh; tanki štipići kruha; tijesta za kruh; tost (preprženi kruh); tostirani kruh; voćni kruh		
-------	--	--	--

(111)	<b>Z20230929</b>	(151)	05.03.2024.
		(450)	15.03.2024.
(210)	Z20230929A	(220)	29.09.2023.
		(181)	<b>29.09.2033.</b>
(732)	<b>UDRUGA ŽENA MARUŠA, MARUŠEVEC</b>		



(540) Maruševec 75, 42243 Maruševec, HR



(591) smeđa, bež  
(531) 26.01.01; 26.01.04; 26.01.05; 26.01.06; 26.01.12; 26.01.15; 26.01.16; 26.01.18; 26.01.21; 27.05.01; 27.05.02; 27.05.08; 27.05.11; 27.05.12; 29.01.02; 29.01.07  
(511) 30 kolači  
35 oglašavanje  
41 obuka za područje pravljenja kolača (za kojega se vrši zaštita); prikazivanje javnosti umjetničkih i literarnih dijela u kulturne i odgojne svrhe; stručno osposobljavanje; razonoda

### RAZRED 31

(111) **Z20230769** (151) 29.02.2024.  
(450) 15.03.2024.  
(210) Z20230769A (220) 14.08.2023.  
(181) 14.08.2033.  
(732) **BİBERCİLER İÇ DIŞ GIDA MADDELERİ PAZARLAMA TİCARET LİMİTED ŞİRKETİ**  
Kulak Mahallesi, 7101 Sokak, Biberçiler, No:2 A, 33270 Akdeniz - Mersin, TR  
(740) ZMP IP d.o.o., Zagreb, HR  
(540)



(591) zelena, svjetlozelena, svjetlocrvena, crvena, tamno crvena, smeđa  
(531) 05.07.13; 05.07.21; 27.05.01; 29.01.01; 29.01.06; 29.01.07  
(511) 31 poljoprivredni i hortikulturni proizvodi koji nisu obuhvaćeni drugim razredima, sjeme; šumarski proizvodi koji nisu obuhvaćeni drugim razredima; žive životinje; oplodena jaja za nasad; biljke; sušene biljke za ukras; svježe vrtno bilje; sušeno vrtno bilje za ukras; hrana za životinje; slad za pivovare i destilerije; pješčani papir [stelja] za kućne ljubimce; stelja za mačke

### RAZRED 32

(111) **Z20230854** (151) 29.02.2024.  
(450) 15.03.2024.  
(210) Z20230854A (220) 08.09.2023.  
(181) 08.09.2033.  
(732) **Ličanka proizvodnja pića d.o.o.**  
Novoselija 70A, 53213 Donje Pazarište, HR  
(540)



(591) crna, zlatna, zelena, smeđa, boja pijeska, plava, crvena  
(531) 25.01.01; 09.01.10; 26.01.02; 26.01.14; 26.01.15; 18.01.12; 18.01.01; 27.01.12  
(511) 32 pivo

### RAZRED 33

(111) **Z20230849** (151) 29.02.2024.  
(450) 15.03.2024.  
(210) Z20230849A (220) 08.09.2023.  
(181) 08.09.2033.  
(732) **KONZUM plus društvo s ograničenom odgovornošću za trgovinu**  
Marijana Čavića 1/a, 10000 Zagreb, HR  
(740) Odvjetničko društvo VUKINA & PARTNERI d.o.o., Zagreb, HR  
(540)



(531) 27.05.01; 27.05.13; 29.01.08  
(511) 33 alkoholna pića (osim piva)

### RAZRED 34

(111) **Z20230936** (151) 08.03.2024.  
(450) 15.03.2024.  
(210) Z20230936A (220) 03.10.2023.  
(181) 03.10.2033.  
(732) **Dunhill Tobacco of London Limited**  
Globe House, 4 Temple Place, WC2R 2PG London, GB  
(740) ZMP IP d.o.o., Zagreb, HR  
(540)



(531) 26.04.02; 26.04.07; 26.04.12; 26.04.16; 26.04.18; 26.04.24; 27.05.01; 27.05.08; 27.05.09; 27.05.10; 27.05.11; 27.05.12; 27.05.24; 29.01.06; 29.01.08  
(511) 34 cigarete; cigare; cigarilosi; duhan za motanje; duhan za lulu; duhanski proizvodi i elektronički uređaji i njihovi dijelovi za zagrijavanje duhana

### RAZRED 35

(111) **Z20230108** (151) 07.03.2024.  
(450) 15.03.2024.  
(210) Z20230108A (220) 10.02.2023.  
(181) 10.02.2033.  
(732) **HAKL SPORT d.o.o.**  
Savska opatovina 36, 10090 Zagreb, HR  
(540)

### HAKL

(511) 35 pružanje internetskog tržišnog prostora za kupce i prodavatelje proizvoda i usluga  
42 informatički sustavi (osmišljavanje informatičkih sustava); razvoj softvera u okviru izdavanja softvera

(111) **Z20230214** (151) 01.03.2024.  
(450) 15.03.2024.  
(210) Z20230214A (220) 07.03.2023.  
(181) 07.03.2033.  
(732) **Ivan Jurić-Kačunić**

Radmanovačka ulica 6P, 10000 Zagreb, HR  
 Kristina Rakuša, Zagreb, HR

(740)  
 (540)

## MyMusic

(511) 35 oglašavanje i reklamiranje; vođenje komercijalnih poslova; komercijalna administracija; uredski poslovi

(111)	<b>Z20230555</b>	(151)	29.02.2024.
		(450)	15.03.2024.
(210)	Z20230555A	(220)	05.06.2023.
		(181)	<b>05.06.2033.</b>

(732) **Antun Najcer**  
 Torbarova 16, 10000 Zagreb, HR

(540)

## SOUL KITCHEN

(511) 35 oglašavanje i reklamiranje; vođenje komercijalnih poslova; komercijalna administracija; uredski poslovi; agencije za komercijalne obavijesti; agencije za uvoz-izvoz; analiza proizvodne cijene; iznajmljivanje automata; daktilografske usluge; prodaja na dražbi; gospodarska predviđanja/prognoze; heliografsko umnožavanje; administrativno upravljanje hotelima; poslovne informacije; vođenje informatičkih kartoteka; pretraživanje podataka u informatičkoj kartoteci za treće; umnožavanje isprava; istraživanja za poslove; istraživanje javnog mišljenja; istraživanje za poslove; izbor osoblja psihotehničkim postupkom; uređivanje izloga; organiziranje izložbi u komercijalne ili reklamne svrhe; iznajmljivanje automata za prodaju sitne robe; iznajmljivanje fotokopirnih uređaja; iznajmljivanje reklamnih prostora; iznajmljivanje reklamnog materijala; iznajmljivanje uredskih strojeva i aparata; iznajmljivanje vremena za reklamiranje na svim komunikacijskim sredstvima; izrada poreznih prijava; izrada izvadaka iz računa; agencije za uvoz-izvoz; istraživanje javnog mijenja/anketiranje; prikupljanje podataka u središnju kartoteku; sistematiziranje podataka za središnju kartoteku; vođenje knjiga; pomoć u vođenju komercijalnih ili industrijskih poduzeća; konzultacije u svezi vođenja poslova; lociranje teretnih vagona pomoću računala; manekenske usluge za reklamiranje ili promicanje prodaje; usluge nabave za treće/kupnja proizvoda i usluga za druga poduzeća; usluge pretplate na novine za treće osobe; uredi za komercijalne obavijesti; obavještenja o poslovima; objavljivanje reklamnih tekstova; odnosi s javnošću/propaganda; širenje reklamnih oglasa; oglašavanje/reklamiranje; organiziranje izložbi u komercijalne ili reklamne svrhe; savjetovanje o organiziranju poslova; biranje osoblja psihotehničkim postupkom; savjetovanje o osoblju; zapošljavanje osoblja; plakatiranje/oglašavanje; izrada platnih listova; pomoć u vođenju komercijalnih ili industrijskih poduzeća; usluge preseljenja za poduzeća; pomoć u upravljanju industrijskim ili trgovačkim poduzećima; pomoć u vođenju poslova; ispunjavanje poreznih prijava; istraživanje za poslove; izviđanje za poslove; konzultacije za vođenje poslova; savjetovanje o organizaciji i vođenju poslova; vještačenje poslova/ekspertize; poslovne obavijesti; usluge praćenja tiska; predstavljanje proizvoda/demonstracija; usluge pretplate na novine za treće osobe; prijepisi priopćenja; procjene komercijalnih poslova; promicanje prodaje za treće osobe; prodaja na dražbi; analiza proizvodnih cijena; propagandni poslovi; proučavanje tržišta/marketing; provjera računa; psihotehnički izbor osoblja; računovodstveni poslovi; reklamiranje putem radija; razdioba (raspačavanje) reklamnih materijala/letaka, prospekata, tiskanica, uzoraka; razdioba reklamnih oglasa; iznajmljivanje prostora za potrebe reklamiranja; reklamiranje dopisnim putem; reklamiranje on-line na informatičkoj mreži; reklamiranje putem radija; reklamiranje putem televizije; uređenje reklamne dokumentacije; reklamna pošta; iznajmljivanje reklamnog materijala; razdioba reklamnog materijala (traktata, prospekata, tiskanica i uzoraka); raznošenje reklamnog materijala; objavljivanje reklamnih tekstova; organiziranje sajмова u reklamne ili komercijalne svrhe; savjeti o organizaciji ili vođenju poslova; stručno

savjetovanje o poslovima; savjetovanje o osoblju; statističko obavještanje; stenografske usluge; stručne poslovne konzultacije; tajništvo (tajničke usluge); obrada teksta; služba za telefonski odgovora za odsutne pretplatnike; televizijsko reklamiranje; praćenje tiska; procjene trgovačkih poslova; proučavanje tržišta; traženje tržišta; profesionalno upravljanje umjetničkim poslovima; umnožavanje isprava; uredi za reklamiranje; uredi za zapošljavanje; iznajmljivanje uredski strojeva i aparata; uređenje izloga; agencije za uvoz-izvoz; razdioba uzoraka; vođenje knjiga; pomoć u vođenju poslova; savjetodavne službe za vođenje poslova; savjetovanje o vođenju poslova; uredi za zapošljavanje; zapošljavanje osoblja

41 obuka; stručno osposobljavanje; razonoda; sportske i kulturne djelatnosti; agencije za modele za slikare i kipare; akademije/obuka; cirkusi; cirkusi/zabavni parkovi; usluge digitalnog snimanja; usluge diskoteka; obuka putem dopisivanja; iskorištavanje elektroničkih publikacija koje se ne mogu kopirati; elektroničko on-line objavljivanje knjiga i časopisa; proizvodnja filmova; serija i drugih audiovizualnih materijala; fizička kultura; fotografiranje; fotografske reportaže; gimnastička obuka; iskorištavanje igrališta za golf; iskorištavanje dvorana za igre; iskorištavanje kinodvorana; izdavanje knjiga; organiziranje izložbi u kulturne ili odgojne svrhe; iznajmljivanje audiouređaja; iznajmljivanje kinematografskih filmova; iznajmljivanje kinoaparature i pribora; iznajmljivanje magnetoskopa; iznajmljivanje radijskih i televizijskih aparata; iznajmljivanje rasvjetnih uređaja za kazališnu dekoraciju i za televizijska studija; iznajmljivanje ronilačke opreme; iznajmljivanje stadiona; iznajmljivanje športske opreme/osim vozila; iznajmljivanje teniskih igrališta; iznajmljivanje ukrasa za priredbe; iznajmljivanje videokamera; iznajmljivanje videotraka; iznajmljivanje zvučnih snimaka; usluge kampova za ljetovanje/zabava; kampovi za športsko usavršavanje; stavljanje na raspolaganje opreme za karaoke; kazališne predstave; iznajmljivanje kazališnog dekora; usluge kazališnih glumaca; usluge kazališnih poduzetnika/impresarija; iznajmljivanje kinematografskih filmova; iznajmljivanje kinoaparature i pribora; iskorištavanje kinodvorana, kinostudija; usluge klubova/zabava ili odgoj; izdavanje knjiga; posuđivanje knjiga; usluge kockarnica/igre; komponiranje glazbe; organiziranje i vođenje konferencija; organiziranje i vođenje kongresa; kročenje životinja; organiziranje lutrije; usluge kampova za ljetovanje/razonoda; iznajmljivanje magnetoskopa; snimanje na mikrofilmove; mikroizdavaštvo; mjerenje vremena na športskim natjecanjima; montaža radijskih i televizijskih programa; muzejske usluge/predstavljanje; izložbe; organiziranje natječaja/obuka ili zabava; noćni klubovi; obavijesti o odgoju; obavijesti o razonodi; obavijesti u svezi rekreacije; objavljivanje tekstova/osim reklamnih tekstova; obuka; obuka putem dopisivanja; obuka za predškolski uzrast; obavijesti o odgoju; odgoj/obuka; odgojni zavodi/internati; organiziranje i vođenje konferencija; organiziranje koncerata; organiziranje i vođenje kongresa; organiziranje i vođenje razgovora; organiziranje i vođenje seminara; organiziranje izložaba u kulturne i odgojne svrhe; organiziranje natječaja/obrazovanje ili razonoda; organiziranje natječaja ljepote; organiziranje plesova; organiziranje spektakla/usluge impresarija; organiziranje športskih natjecanja; usluge orkestra; pedagoški pokusi; planiranje prijema/zabava; posuđivanje knjiga; poučavanje/instrukcije; praktična obuka/demonstriranje; predškolska obuka; prevodilačke usluge; prijemi (planiranje prijema)/razonoda; iznajmljivanje ukrasa za priredbe; održavanje priredbi; organiziranje priredbi/usluge impresarija; proizvodnja priredbi; profesionalna orijentacija (savjeti u svezi odgoja ili osposobljavanja); proizvodnja filmova; proizvodnja filmova na videotrakama; usluge putujućih biblioteka; montaža radijskih i televizijskih programa; iznajmljivanje radioaparata i televizora; radiofonija (montaža televizijskih i radio programa); razonoda putem radiofonije; organiziranje i vođenje razgovora; razonoda; obavijesti u svezi razonode; razonoda posredstvom radija; razonoda posredstvom televizije; obavijesti u svezi rekreacije; religiozni odgoj; fotografske reportaže; reporterske usluge; rezerviranje mjesta za priredbe; iznajmljivanje ronilačke opreme; izrada scenarija; organiziranje i vođenje seminara; organiziranje i vođenje simpozija; sinkronizacija; usluge za ispunjavanje slobodnog vremena; snimanje na videotrake; iznajmljivanje stadiona; usluge studija za snimanje; mjerenje

vremena na športskim natjecanjima; organiziranje športskih natjecanja; iskorištavanje športske opreme; iznajmljivanje športske opreme osim vozila; športski kampovi za usavršavanje u športu; objavljivanje tekstova/osim u reklamne svrhe; rasonoda na televiziji; montaža radijskih i televizijskih programa; iznajmljivanje televizora i radioaparata; titlovanje filmova; tumačenje govora pokreta; iznajmljivanje ukrasa za priredbe; varijete/music-hall; iznajmljivanje videotraka; proizvodnja filmova na videotrakama; snimanje na videotrake; zabavni parkovi; zabavni parkovi/cirkusi; zdravstveni klubovi/održavanje fizičkog zdravlja; iskorištavanje zooloških vrtova; iznajmljivanje zvučnih snimaka; kročenje životinja; organiziranje i vođenje radionica za stručno osposobljavanje

- 43** usluge pružanja hrane i pića; pružanje privremenog smještaja; barovi (usluge barova); gostioničari (usluge gostioničara); hotelske rezervacije (usluge rezerviranja hotela); hotelske usluge; iznajmljivanje aparata za kuhanje; iznajmljivanje dvorana za sastanke; iznajmljivanje prenosivih građevinskih objekata, iznajmljivanje privremenog smještaja; iznajmljivanje rasvjetnih uređaja; iznajmljivanje stolaca, stolova, stalnog rublja i staklenog posuđa; iznajmljivanje šatora; iznajmljivanje uređaja za pitku vodu; jasllice [dječji vrtići]; kampiranje (stavljanje na raspolaganje terena za kampiranje); kampovi za ljetovanje (usluge kampova za ljetovanje)[smještaj]; nargila barovi; oblikovanje hrane; pension za životinje; pružanje informacija i savjeta u vezi s pripremanjem obroka; rezerviranje pensiona; rezerviranje privremenog smještaja; ukrašavanje hrane; ukrašavanje kolača; usluge iznajmljivanja smještaja [hotelski, pensionski]; usluge kafeterija; usluge kafića; usluge kantina; usluge kuća za odmor; usluge motela; usluge osobnog šefa kuhinje; usluge pansiona; usluge prijma za privremeni smještaj [upravljanje dolascima i odlascima]; usluge restorana; usluge restorana sa samoposluživanjem; usluge restorana u kojima se nude rezanci udon i soba; usluge snek barova; usluge ustanova za smještaj starijih osoba; usluge washoku restorana

(111)	<b>Z20230625</b>	(151)	08.03.2024.
		(450)	15.03.2024.
(210)	Z20230625A	(220)	26.06.2023.
		(181)	<b>26.06.2033.</b>
(732)	<b>Davorin Purgarić</b>		
(540)	Supilova 50b, 42000 Varaždin, HR		

## Konceptura

- (511) **35** marketinški poslovni savjeti; poslovni savjeti; poslovni savjeti u svezi strateškog marketinga; poslovni savjeti u svezi financiranja razvoja; savjeti u svezi s poslovnim upravljanjem; savjeti u svezi s organizacijom i upravljanjem poslovnim djelatnostima; poslovno upravljanje; upravljanje ljudskim potencijalima; uređivanje promidžbenih tekstova; usluge preustroja poslovnih procesa; razvoj marketinških koncepata; razvoj koncepata za poslovno gospodarstvo; priprema i izvedba medijskih i reklamnih planova i koncepata; konzultantske usluge u području razvoja koncepata oglašavanja; poslovno planiranje; planiranje marketinških strategija; planiranje poslovnog upravljanja; strateško planiranje poslovanja; poslovna organizacija; organizacija i provedba promotivnih događanja; poslovno istraživanje; marketinška istraživanja; istraživanje tržišta i analize tržišnih istraživanja; izrada poslovnih istraživanja; istraživanja o poslovnoj učinkovitosti; savjetovanje u svezi poslovne učinkovitosti
- 41** upravljanje obrazovnim uslugama; obrazovne usluge u svezi s očuvanjem okoliša; obrazovanje i osposobljavanje u vezi s očuvanjem prirode i okoliša; provođenje edukativnih radionica na području poslovanja; pružanje obrazovanja i poduke; savjetodavne usluge u svezi s obrazovanjem; organiziranje sastanaka u svezi s obrazovanjem; organiziranje simpozija u svezi s obrazovanjem; organiziranje konferencija u svezi s obrazovanjem; organiziranje seminara u svezi s obrazovanjem; izdavanje priručnika za obrazovanje i osposobljavanje; konzultantske usluge u svezi s poslovnim obrazovanjem; izdavanje publikacija; izdavanje obrazovnog materijala; izdavanje obrazovnih knjiga;

izdavanje elektroničkih časopisa; uređivanje fotografija; uređivanje pisanih tekstova; uređivanje tekstova [osim promidžbenih tekstova]; uređivanje tiskanog materijala koji sadrži slike, osim za reklamne svrhe; organizacija webinara; organizacija tečajeva; organizacija konvencija; organizacija osposobljavanja; organizacija tečajeva izobrazbe; simpoziji (organizacija i vođenje simpozija); dogovaranje, izvođenje i organizacija konferencija; dogovaranje, izvođenje i organizacija kongresa; organizacija i izvođenje tečajeva osposobljavanja; organizacija i vođenje kulturnih aktivnosti; radionice u kulturne svrhe; organiziranje prezentacija u kulturne svrhe; organiziranje priredbi u kulturne svrhe; organiziranje izložbi u kulturne svrhe; organizacija zabavnih i kulturnih događaja; organiziranje seminara u svezi s kulturnim aktivnostima; organiziranje konferencija u svezi s kulturnim aktivnostima; organizacija kongresa i konferencija za kulturne i obrazovne svrhe

- 42** urbanistički razvoj; upravljanje arhitektonskim projektima; prikupljanje podataka o uvjetima u okolišu; istraživanje u području održavanja okoliša; savjetodavne usluge u svezi sa zaštitom okoliša; arhitektonsko savjetovanje; arhitektura; arhitektonske savjetodavne usluge; usluge arhitektonskog i urbanističko planiranja; planiranje u svezi s urbanim planiranjem i planiranjem komercijalnog dijela grada; upravljanje poslovnim sadržajem; razvoj industrijskih procesa; koncepcija audiovizualnih stvaralačkih djela; urbano planiranje; projektno planiranje; usluge istraživanja; izrada [koncipiranje] računalnih programa; savjetodavne usluge u svezi s energetskom učinkovitosti

(111)	<b>Z20230762</b>	(151)	07.03.2024.
		(450)	15.03.2024.
(210)	Z20230762A	(220)	11.08.2023.
		(181)	<b>11.08.2033.</b>
(732)	<b>CHECKSUM d.o.o.</b>		
(540)	Ulica Augusta Harambašića 19, 10434 Strmec, HR		



- (591) plava
- (531) 24.17.20; 26.03.02; 26.04.01; 27.05.01; 29.01.04
- (511) **35** usluge oglašavanja, marketinga i promidžbe; usluge poslovne pomoći, upravljanja i administracije
- 42** usluge informacijske tehnologije; računalne usluge; usluge projektiranja; ispitivanje, provjera autentičnosti i kontrola kvalitete; usluge znanosti i tehnologije; usluge dizajna

(111)	<b>Z20230785</b>	(151)	27.02.2024.
		(450)	15.03.2024.
(210)	Z20230785A	(220)	21.08.2023.
		(181)	<b>21.08.2033.</b>
(732)	<b>DENTON ADRIA d.o.o.</b>		
(740)	Gundulićeva ulica 50, 10000 Zagreb, HR		
(540)	Petra Đerek Ivezić, Zagreb, HR		



**LABINECA**  
HOTEL

- (591) plava
- (531) 26.01.01; 26.01.03; 26.01.18; 27.05.01; 27.05.19; 27.05.22; 27.05.09; 27.05.10
- (511) **35** poslovno upravljanje hotelima; usluge oglašavanja u svezi s hotelima; konzultantske usluge povezane s administracijom i upravljanjem hotelima; upravljanje hotelima za druge; administrativno upravljanje hotelom; tajničke usluge koje pružaju hoteli; usluge oglašavanja;

oglašavanje i marketing; usluge oglašavanja, marketinga i promidžbe; usluge oglašavanja u svezi s turističkim industrijama; usluge recepcije za posjetitelje [uredski poslovi]; usluge uredskih funkcija; digitalni marketing; marketinške usluge u području putovanja; distribucija oglasnog, marketinškog i promotivnog materijala

- 39 organiziranje prijevoza do i od hotela; rezervacije putovanja; planiranje putovanja; organiziranje putovanja; rezervacije (putovanja); usluge rezervacije turističkih putovanja; organizacija i rezervacija putovanja; informativne usluge u svezi s putovanjem; davanje turističkih putnih informacija putem interneta; iznajmljivanje garaža i parkirnih mjesta; usluge razgledavanja i izleta; organizacija prijevoza i putovanja
- 41 zabavne usluge hotela; hoteljerske usluge [zabava]; pružanje zabavnih sadržaja u hotelima; ponuda zabavnih objekata u hotelima; usluge kampa (turističke) [zabava]; ljetovanje (usluge kampova za ljetovanje) [razonoda]; animacijske usluge u kampovima za odmor; dogovaranje, izvođenje i organizacija konferencija; dogovaranje, izvođenje i organizacija koncerata; zabavne, sportske i kulturne aktivnosti; rekreacijske usluge; ponuda rekreacijskih aktivnosti; pružanje glazbene zabave
- 43 hotelske usluge; hotelske rezervacije; informacije o hotelima; usluge hotelskog smještaja; usluge hotelskih restorana; organiziranje hotelskog smještaja; ponuda hotelskog smještaja; pružanje hotelskog smještaja; rezervacija hotelskog smještaja; hoteljerske usluge [smještaj]; usluge hotela u odmaralištima; iznajmljivanje ručnika za hotele; pripremanje obroka u hotelima; usluge restorana koje pružaju hoteli; pružanje usluga hotela i motela; informacije u svezi s hotelima; hotelske usluge za povlaštene klijente; rezerviranje hotelskih soba za putnike; hoteljerske usluge [hrana i piće]; pružanje informacija u svezi s hotelima; hoteli, hosteli i pansioni i turistički smještaj; usluge pružanja elektroničkih informacija u svezi s hotelima; konzultantske usluge u svezi s hotelskim prostorijama i opremom; usluge turističkih kampova [smještaj]; ljetovanje [usluge kampova za ljetovanje]; parkirališta s infrastrukturom za kamp kućice (pružanje); usluge pružanja informacija, savjetovanja i rezervacija u vezi privremenog smještaja

putovanja; rezervacije (putovanja); usluge rezervacije turističkih putovanja; organizacija i rezervacija putovanja; informativne usluge u svezi s putovanjem; davanje turističkih putnih informacija putem interneta; iznajmljivanje garaža i parkirnih mjesta; usluge razgledavanja i izleta; organizacija prijevoza i putovanja

- 41 zabavne usluge hotela; hoteljerske usluge [zabava]; pružanje zabavnih sadržaja u hotelima; ponuda zabavnih objekata u hotelima; usluge kampa (turističke) [zabava]; ljetovanje (usluge kampova za ljetovanje) [razonoda]; animacijske usluge u kampovima za odmor; dogovaranje, izvođenje i organizacija konferencija; dogovaranje, izvođenje i organizacija koncerata; zabavne, sportske i kulturne aktivnosti; rekreacijske usluge; ponuda rekreacijskih aktivnosti; pružanje glazbene zabave
- 43 hotelske usluge; hotelske rezervacije; informacije o hotelima; usluge hotelskog smještaja; usluge hotelskih restorana; organiziranje hotelskog smještaja; ponuda hotelskog smještaja; pružanje hotelskog smještaja; rezervacija hotelskog smještaja; hoteljerske usluge [smještaj]; usluge hotela u odmaralištima; iznajmljivanje ručnika za hotele; pripremanje obroka u hotelima; usluge restorana koje pružaju hoteli; pružanje usluga hotela i motela; informacije u svezi s hotelima; hotelske usluge za povlaštene klijente; rezerviranje hotelskih soba za putnike; hoteljerske usluge [hrana i piće]; pružanje informacija u svezi s hotelima; hoteli, hosteli i pansioni i turistički smještaj; usluge pružanja elektroničkih informacija u svezi s hotelima; konzultantske usluge u svezi s hotelskim prostorijama i opremom; usluge turističkih kampova [smještaj]; ljetovanje [usluge kampova za ljetovanje]; parkirališta s infrastrukturom za kamp kućice (pružanje); usluge pružanja informacija, savjetovanja i rezervacija u vezi privremenog smještaja

(111)	<b>Z20230795</b>	(151)	27.02.2024.
(210)	Z20230795A	(450)	15.03.2024.
(732)	<b>DENTON ADRIA d.o.o.</b>	(220)	22.08.2023.
(740)	Gundulićeva ulica 50, 10000 Zagreb, HR	(181)	<b>22.08.2033.</b>
(540)	Petra Đerek Ivezić, Zagreb, HR		

(111)	<b>Z20230786</b>	(151)	27.02.2024.
(210)	Z20230786A	(450)	15.03.2024.
(732)	<b>DENTON ADRIA d.o.o.</b>	(220)	21.08.2023.
(740)	Gundulićeva ulica 50, 10000 Zagreb, HR	(181)	<b>21.08.2033.</b>
(540)	Petra Đerek Ivezić, Zagreb, HR		



**FARAON**  
HOTEL

- (591) plava
- (531) 26.01.01; 26.01.03; 26.01.18; 27.05.19; 27.05.22; 27.05.09; 27.05.10
- (511) 35 poslovno upravljanje hotelima; usluge oglašavanja u svezi s hotelima; konzultantske usluge povezane s administracijom i upravljanjem hotelima; upravljanje hotelima za druge; administrativno upravljanje hotelom; tajničke usluge koje pružaju hoteli; usluge oglašavanja; oglašavanje i marketing; usluge oglašavanja, marketinga i promidžbe; usluge oglašavanja u svezi s turističkim industrijama; usluge recepcije za posjetitelje [uredski poslovi]; usluge uredskih funkcija; digitalni marketing; marketinške usluge u području putovanja; distribucija oglasnog, marketinškog i promotivnog materijala
- 39 organiziranje prijevoza do i od hotela; rezervacije putovanja; planiranje putovanja; organiziranje



**ADRIATIC**  
AUTOCAMP

- (591) plava, tamno plava
- (531) 07.01.20; 01.15.24; 05.03.20; 26.01.01; 26.01.10; 26.01.13; 26.01.15; 26.01.16; 27.05.10
- (511) 35 usluge oglašavanja u svezi s turističkim industrijama; usluge recepcije za posjetitelje [uredski poslovi]; usluge oglašavanja, marketinga i promidžbe
- 39 usluge rezervacije turističkih putovanja; organizacija i rezervacija putovanja; informativne usluge u svezi s putovanjem; davanje turističkih putnih informacija putem interneta; iznajmljivanje garaža i parkirnih mjesta; usluge razgledavanja i izleta; organizacija prijevoza i putovanja
- 41 usluge kampa (turističke) [zabava]; ljetovanje (usluge kampova za ljetovanje) [razonoda]; animacijske usluge u kampovima za odmor; dogovaranje, izvođenje i organizacija konferencija; dogovaranje, izvođenje i organizacija koncerata; zabavne, sportske i kulturne aktivnosti; rekreacijske usluge; ponuda rekreacijskih aktivnosti; pružanje glazbene zabave; animacijske usluge u kampovima za odmor
- 43 usluge turističkih kampova [smještaj]; ljetovanje [usluge kampova za ljetovanje]; parkirališta s infrastrukturom za kamp kućice (pružanje); usluge pružanja informacija, savjetovanja i rezervacija u vezi privremenog smještaja; pružanje hrane i pića

(111)	<b>Z20230796</b>	(151)	27.02.2024.
		(450)	15.03.2024.
(210)	Z20230796A	(220)	22.08.2023.
		(181)	<b>22.08.2033.</b>
(732)	<b>DENTON ADRIA d.o.o.</b>		
(740)	Gundulićeva ulica 50, 10000 Zagreb, HR		
(540)	Petra Đerek Ivezić, Zagreb, HR		



(591)	zelena, crna, siva		
(531)	05.03.20; 05.01.16; 26.01.01; 26.01.15; 27.05.01; 27.05.10		
(511)	35	poslovno upravljanje hotelima; usluge oglašavanja u svezi s hotelima; konzultantske usluge povezane s administracijom i upravljanjem hotelima; upravljanje hotelima za druge; administrativno upravljanje hotelom; tajničke usluge koje pružaju hoteli; usluge oglašavanja; oglašavanje i marketing; usluge oglašavanja, marketinga i promidžbe; usluge oglašavanja u svezi s turističkim industrijama; usluge recepcije za posjetitelje [uredski poslovi]; usluge uredskih funkcija; digitalni marketing; marketinške usluge u području putovanja; distribucija oglasnog, marketinškog i promotivnog materijala	
	39	organiziranje prijevoza do i od hotela; rezervacije putovanja; planiranje putovanja; organiziranje putovanja; rezervacije (putovanja); usluge rezervacije turističkih putovanja; organizacija i rezervacija putovanja; informativne usluge u svezi s putovanjem; davanje turističkih putnih informacija putem interneta; iznajmljivanje garaža i parkirnih mjesta; usluge razgledavanja i izleta; organizacija prijevoza i putovanja; usluge marine; usluge marine [pristanišne usluge]; usluge marine [pristanišne, vezivanje, skladištenje]; pružanje informacija u svezi s marinama	
	41	zabavne usluge hotela; hoteljerske usluge [zabava]; pružanje zabavnih sadržaja u hotelima; ponuda zabavnih objekata u hotelima; usluge kampa (turističke) [zabava]; ljetovanje (usluge kampova za ljetovanje) [razonoda]; animacijske usluge u kampovima za odmor; dogovaranje, izvođenje i organizacija konferencija; dogovaranje, izvođenje i organizacija koncerata; zabavne, sportske i kulturne aktivnosti; rekreacijske usluge; ponuda rekreacijskih aktivnosti; pružanje glazbene zabave	
	43	hotelske usluge; hotelske rezervacije; informacije o hotelima; usluge hotelskog smještaja; usluge hotelskih restorana; organiziranje hotelskog smještaja; ponuda hotelskog smještaja; pružanje hotelskog smještaja; rezervacija hotelskog smještaja; hoteljerske usluge [smještaj]; usluge hotela u odmaralištima; iznajmljivanje ručnika za hotele; pripremanje obroka u hotelima; usluge restorana koje pružaju hoteli; pružanje usluga hotela i motela; informacije u svezi s hotelima; hotelske usluge za povlaštene klijente; rezerviranje hotelskih soba za putnike; hoteljerske usluge [hrana i piće]; pružanje informacija u svezi s hotelima; hoteli, hosteli i pansioni i turistički smještaj; usluge pružanja elektroničkih informacija u svezi s hotelima; konzultantske usluge u svezi s hotelskim prostorijama i opremom; usluge turističkih kampova [smještaj]; ljetovanje [usluge kampova za ljetovanje]; parkirališta s infrastrukturom za kamp kućice (pružanje); usluge pružanja informacija, savjetovanja i rezervacija u vezi privremenog smještaja; pružanje hrane i pića	

(111)	<b>Z20230799</b>	(151)	27.02.2024.
		(450)	15.03.2024.
(210)	Z20230799A	(220)	24.08.2023.
		(181)	<b>24.08.2033.</b>
(732)	<b>DENTON ADRIA d.o.o.</b>		

Gundulićeva ulica 50, 10000 Zagreb, HR  
Petra Đerek Ivezić, Zagreb, HR

(740)  
(540)



**HVAR**  
HOTEL - JELSA

(591)	zelena		
(531)	26.01.01; 26.01.03; 26.01.15; 05.01.16; 05.01.05; 27.05.10		
(511)	35	poslovno upravljanje hotelima; usluge oglašavanja u svezi s hotelima; konzultantske usluge povezane s administracijom i upravljanjem hotelima; upravljanje hotelima za druge; administrativno upravljanje hotelom; tajničke usluge koje pružaju hoteli; usluge oglašavanja; oglašavanje i marketing; usluge oglašavanja, marketinga i promidžbe; usluge oglašavanja u svezi s turističkim industrijama; usluge recepcije za posjetitelje [uredski poslovi]; usluge uredskih funkcija; digitalni marketing; marketinške usluge u području putovanja; distribucija oglasnog, marketinškog i promotivnog materijala	
	39	organiziranje prijevoza do i od hotela; rezervacije putovanja; planiranje putovanja; organiziranje putovanja; rezervacije (putovanja); usluge rezervacije turističkih putovanja; organizacija i rezervacija putovanja; informativne usluge u svezi s putovanjem; davanje turističkih putnih informacija putem interneta; iznajmljivanje garaža i parkirnih mjesta; usluge razgledavanja i izleta; organizacija prijevoza i putovanja	
	41	zabavne usluge hotela; hoteljerske usluge [zabava]; pružanje zabavnih sadržaja u hotelima; ponuda zabavnih objekata u hotelima; usluge kampa (turističke) [zabava]; ljetovanje (usluge kampova za ljetovanje) [razonoda]; animacijske usluge u kampovima za odmor; dogovaranje, izvođenje i organizacija konferencija; dogovaranje, izvođenje i organizacija koncerata; zabavne, sportske i kulturne aktivnosti; rekreacijske usluge; ponuda rekreacijskih aktivnosti; pružanje glazbene zabave	
	43	hotelske usluge; hotelske rezervacije; informacije o hotelima; usluge hotelskog smještaja; usluge hotelskih restorana; organiziranje hotelskog smještaja; ponuda hotelskog smještaja; pružanje hotelskog smještaja; rezervacija hotelskog smještaja; hoteljerske usluge [smještaj]; usluge hotela u odmaralištima; iznajmljivanje ručnika za hotele; pripremanje obroka u hotelima; usluge restorana koje pružaju hoteli; pružanje usluga hotela i motela; informacije u svezi s hotelima; hotelske usluge za povlaštene klijente; rezerviranje hotelskih soba za putnike; hoteljerske usluge [hrana i piće]; pružanje informacija u svezi s hotelima; hoteli, hosteli i pansioni i turistički smještaj; usluge pružanja elektroničkih informacija u svezi s hotelima; konzultantske usluge u svezi s hotelskim prostorijama i opremom; usluge turističkih kampova [smještaj]; ljetovanje [usluge kampova za ljetovanje]; parkirališta s infrastrukturom za kamp kućice (pružanje); usluge pružanja informacija, savjetovanja i rezervacija u vezi privremenog smještaja	

(111)	<b>Z20230800</b>	(151)	27.02.2024.
		(450)	15.03.2024.
(210)	Z20230800A	(220)	24.08.2023.
		(181)	<b>24.08.2033.</b>
(732)	<b>DENTON ADRIA d.o.o.</b>		
(740)	Gundulićeva ulica 50, 10000 Zagreb, HR		
(540)	Petra Đerek Ivezić, Zagreb, HR		



**FONTANA**  
RESORT

- (591) plava  
(531) 07.01.01; 24.01.25; 24.01.11; 01.15.24; 26.11.13; 26.11.03; 27.05.10  
(511) **35** poslovno upravljanje hotelima; usluge oglašavanja u svezi s hotelima; konzultantske usluge povezane s administracijom i upravljanjem hotelima; upravljanje hotelima za druge; administrativno upravljanje hotelom; tajničke usluge koje pružaju hoteli; usluge oglašavanja; oglašavanje i marketing; usluge oglašavanja, marketinga i promidžbe; usluge oglašavanja u svezi s turističkim industrijama; usluge recepcije za posjetitelje [uredski poslovi]; usluge uredskih funkcija; digitalni marketing; marketinške usluge u području putovanja; distribucija oglasnog, marketinškog i promotivnog materijala  
**39** organiziranje prijevoza do i od hotela; rezervacije putovanja; planiranje putovanja; organiziranje putovanja; rezervacije (putovanja); usluge rezervacije turističkih putovanja; organizacija i rezervacija putovanja; informativne usluge u svezi s putovanjem; davanje turističkih putnih informacija putem interneta; iznajmljivanje garaža i parkirnih mjesta; usluge razgledavanja i izleta; organizacija prijevoza i putovanja  
**41** zabavne usluge hotela; hoteljerske usluge [zabava]; pružanje zabavnih sadržaja u hotelima; ponuda zabavnih objekata u hotelima; usluge kampa (turističke) [zabava]; ljetovanje (usluge kampova za ljetovanje) [razonoda]; animacijske usluge u kampovima za odmor; dogovaranje, izvođenje i organizacija konferencija; dogovaranje, izvođenje i organizacija koncerata; zabavne, sportske i kulturne aktivnosti; rekreacijske usluge; ponuda rekreacijskih aktivnosti; pružanje glazbene zabave  
**43** hotelske usluge; hotelske rezervacije; informacije o hotelima; usluge hotelskog smještaja; usluge hotelskih restorana; organiziranje hotelskog smještaja; ponuda hotelskog smještaja; pružanje hotelskog smještaja; rezervacija hotelskog smještaja; hoteljerske usluge [smještaj]; usluge hotela u odmaralištima; iznajmljivanje ručnika za hotele; pripremanje obroka u hotelima; usluge restorana koje pružaju hoteli; pružanje usluga hotela i motela; informacije u svezi s hotelima; hotelske usluge za povlaštene klijente; rezerviranje hotelskih soba za putnike; hoteljerske usluge [hrana i piće]; pružanje informacija u svezi s hotelima; hoteli, hosteli i pansioni i turistički smještaj; usluge pružanja elektroničkih informacija u svezi s hotelima; konzultantske usluge u svezi s hotelskim prostorijama i opremom; usluge turističkih kampova [smještaj]; ljetovanje [usluge kampova za ljetovanje]; parkirališta s infrastrukturom za kamp kućice (pružanje); usluge pružanja informacija, savjetovanja i rezervacija u vezi privremenog smještaja; pružanje hrane i pića

(111) **Z20230801** (151) 27.02.2024.  
(450) 15.03.2024.  
(210) Z20230801A (220) 24.08.2023.  
(181) **24.08.2033.**  
(732) **DENTON ADRIA d.o.o.**  
Gundulićeva ulica 50, 10000 Zagreb, HR  
(740) Petra Đerek Ivezić, Zagreb, HR  
(540)



**KREMİK**  
MARINA

- (591) plava, svijetloplava  
(531) 09.01.07; 26.01.01; 26.01.03; 26.01.18; 27.05.01; 27.05.05; 27.05.09; 27.05.10; 29.01.04; 29.01.08  
(511) **35** usluge oglašavanja u svezi s turističkim industrijama; usluge recepcije za posjetitelje [uredski poslovi]; digitalni marketing; marketinške usluge u području putovanja  
**39** usluge marine; usluge marine [pristanišne usluge]; usluge marine [pristajanje, vezivanje, skladištenje]; pružanje informacija u svezi s marinama; čarter jahti; iznajmljivanje brodova; iznajmljivanje [čarter] brodice; usluge opskrbe brodova gorivom [skladištenje]; parkiranje i skladištenje vozila, privezivanje plovila  
**41** informacije u svezi s rekreacijom; obavijesti u svezi rekreacije; obavijesti o razonodi; ponuda rekreacijskih aktivnosti  
**43** usluge restorana

(111) **Z20230901** (151) 29.02.2024.  
(450) 15.03.2024.  
(210) Z20230901A (220) 22.09.2023.  
(181) **22.09.2033.**

(732) **REMISENS HOTEL GROUP d.o.o.**  
Miramarska 24, 10000 Zagreb, HR  
(740) Valentina Vižintin, Rijeka, HR  
(540)



- (591) narančasta, bijela  
(531) 29.01.02  
(511) **35** oglašavanje i reklamiranje; vođenje komercijalnih poslova; komercijalna administracija; uredski poslovi  
**38** telekomunikacije  
**39** prijevoz; ambalažiranje i uskladištenje proizvoda; organiziranje putovanja  
**41** obuka; stručno osposobljavanje; razonoda; sportske i kulturne djelatnosti  
**43** usluge okrepe (hranjenje); privremeno primanje na stan  
**44** medicinske usluge; veterinarske usluge; higijenska njega i njega ljepote za ljude ili za životinje; poljoprivredne, povrtarske i šumarske usluge

(111) **Z20230902** (151) 29.02.2024.  
(450) 15.03.2024.  
(210) Z20230902A (220) 22.09.2023.  
(181) **22.09.2033.**

(732) **REMISENS HOTEL GROUP d.o.o.**  
Miramarska 24, 10000 Zagreb, HR  
(740) Valentina Vižintin, Rijeka, HR  
(540)



(591) narančasta, bijela  
(531) 27.05.01  
(511) **35** oglašavanje i reklamiranje; vođenje komercijalnih poslova; komercijalna administracija; uredski poslovi  
**38** telekomunikacije  
**39** prijevoz; ambalažiranje i uskladištenje proizvoda; organiziranje putovanja  
**41** obuka; stručno osposobljavanje; razonoda; sportske i kulturne djelatnosti  
**43** usluge okrepe (hranjenje); privremeno primanje na stan  
**44** medicinske usluge; veterinarske usluge; higijenska njega i njega ljepote za ljude ili za životinje; poljoprivredne, povrtlarske i šumarske usluge

(111) **Z20230903** (151) 29.02.2024.  
(450) 15.03.2024.  
(210) Z20230903A (220) 22.09.2023.  
(181) **22.09.2033.**  
(732) **REMISENS HOTEL GROUP d.o.o.**  
Miramarska 24, 10000 Zagreb, HR  
(740) Valentina Vižintin, Rijeka, HR  
(540)



(591) crna  
(531) 27.05.01  
(511) **35** oglašavanje i reklamiranje; vođenje komercijalnih poslova; komercijalna administracija; uredski poslovi  
**38** telekomunikacije  
**39** prijevoz; ambalažiranje i uskladištenje proizvoda; organiziranje putovanja  
**41** obuka; stručno osposobljavanje; razonoda; sportske i kulturne djelatnosti  
**43** usluge okrepe (hranjenje); privremeno primanje na stan  
**44** medicinske usluge; veterinarske usluge; higijenska njega i njega ljepote za ljude ili za životinje; poljoprivredne, povrtlarske i šumarske usluge

(111) **Z20230904** (151) 29.02.2024.  
(450) 15.03.2024.  
(210) Z20230904A (220) 22.09.2023.  
(181) **22.09.2033.**  
(732) **REMISENS HOTEL GROUP d.o.o.**  
Miramarska 24, 10000 Zagreb, HR  
(740) Valentina Vižintin, Rijeka, HR  
(540)



(591) crna  
(531) 29.01.08  
(511) **35** oglašavanje i reklamiranje; vođenje komercijalnih poslova; komercijalna administracija; uredski poslovi  
**38** telekomunikacije  
**39** prijevoz; ambalažiranje i uskladištenje proizvoda; organiziranje putovanja  
**41** obuka; stručno osposobljavanje; razonoda; sportske i kulturne djelatnosti  
**43** usluge okrepe (hranjenje); privremeno primanje na stan  
**44** medicinske usluge; veterinarske usluge; higijenska njega i njega ljepote za ljude ili za životinje; poljoprivredne, povrtlarske i šumarske usluge

## RAZRED 36

(111) **Z20230591** (151) 29.02.2024.  
(450) 15.03.2024.  
(210) Z20230591A (220) 16.06.2023.  
(310) 40-2022-0231476 (320) 16.12.2022. (330) KR  
(181) **16.06.2033.**  
(732) **Kia Corporation**  
12, Heolleung-ro, Seocho-gu, 06797 Seoul, KR  
(740) Hraste & Partneri odvjetničko društvo d.o.o., Zagreb, HR  
(540)



(531) 27.05.01; 27.05.09; 27.05.19  
(511) **36** izdavanje članskih kreditnih kartica; usluge banke koje uključuju davanje rabata i popusta kod participirajućih ustanova korisnicima članskih iskaznica; usluge plaćanja putem mobilnog interneta; usluge plaćanja putem bežičnih telekomunikacijskih aparata i uređaja; transakcije putem kreditne kartice; obrada platnih transakcija putem interneta; pružanje financijske analize za korisnike instant plaćanja u vozilima; instant plaćanja u vozilima uz funkciju autentifikacije i potvrde plaćanja; usluge mobilnog plaćanja i plaćanja putem interneta u vozilima; usluge automatiziranog plaćanja u vozilima; usluge instant plaćanja u vozilima uz funkciju akumulacije bodova i milja

## RAZRED 41

(111) **Z20230860** (151) 01.03.2024.  
(450) 15.03.2024.  
(210) Z20230860A (220) 11.09.2023.  
(181) **11.09.2033.**  
(732) **PARVE d.o.o.**  
Andrije Medulića 5, 51000 Rijeka, HR  
(540)



(531) 27.05.01  
(511) **41** organiziranje i vođenje koncerata

(111) **Z20230905** (151) 01.03.2024.  
(450) 15.03.2024.  
(210) Z20230905A (220) 25.09.2023.  
(181) **25.09.2033.**  
(732) **Dejvid Hadaš**  
Vladimira Nazora 46, 32261 Rajevo Selo, HR  
(740) Štefan Štefanek, Zagreb, HR  
(540)

# Lipa besida otvara vrata



(511) **43** privremeni smještaj; pružanje hrane i pića; usluge informiranja, savjetovanja i rezervacija u vezi opskrbe hranom i pićem; usluge pružanja informacija, savjetovanja i rezervacija u vezi privremenog smještaja; pružanje privremenog smještaja; usluge privremenog smještaja

(531) 27.05.01  
(511) **41** glazbene izvedbe uživo; glazbeni koncerti; glazbeni koncerti uživo; organiziranje festivala; organiziranje festivala u zabavne svrhe; organiziranje koncerata; organiziranje glazbenih koncerata; organiziranje i vođenje koncerata; zabavne usluge; zabavne usluge glazbenika; obavijesti o razonodi; izvedbe (prikazivanje uživo -); planiranje zabava; planiranje i izvođenje zabava; izdavanje publikacija; dogovaranje, izvođenje i organizacija koncerata; elektroničko online objavljivanje periodika i knjiga

## RAZRED 43

(111) **Z20230616** (151) 11.03.2024.  
(450) 15.03.2024.  
(210) Z20230616A (220) 23.06.2023.  
(181) **23.06.2033.**  
(732) **BOCCA PORTA j.d.o.o.**  
Dolinka 18, 52100 Pula, HR  
(740) Aleksandar Puh, Pula, HR  
(540)

## Boccaporta

(511) **43** pružanje hrane i pića; privremeni smještaj; usluge informiranja, savjetovanja i rezervacija u vezi opskrbe hranom i pićem; usluge pružanja informacija, savjetovanja i rezervacija u vezi privremenog smještaja; pružanje privremenog smještaja; usluge privremenog smještaja

(111) **Z20230617** (151) 01.03.2024.  
(450) 15.03.2024.  
(210) Z20230617A (220) 26.06.2023.  
(181) **26.06.2033.**  
(732) **BOCCA PORTA j.d.o.o.**  
Dolinka 18, 52100 Pula, HR  
(740) Aleksandar Puh, Pula, HR  
(540)

## Konoba starih okusa

(511) **43** privremeni smještaj; pružanje hrane i pića; usluge informiranja, savjetovanja i rezervacija u vezi opskrbe hranom i pićem; usluge pružanja informacija, savjetovanja i rezervacija u vezi privremenog smještaja; pružanje privremenog smještaja; usluge privremenog smještaja

(111) **Z20230618** (151) 11.03.2024.  
(450) 15.03.2024.  
(210) Z20230618A (220) 26.06.2023.  
(181) **26.06.2033.**  
(732) **BOCCA PORTA j.d.o.o.**  
Dolinka 18, 52100 Pula, HR  
(740) Aleksandar Puh, Pula, HR  
(540)

(111) **Z20230619** (151) 11.03.2024.  
(450) 15.03.2024.  
(210) Z20230619A (220) 26.06.2023.  
(181) **26.06.2033.**

(732) **BOCCA PORTA j.d.o.o.**  
Dolinka 18, 52100 Pula, HR  
(740) Aleksandar Puh, Pula, HR  
(540)

## Lijepa riječ otvara vrata

(511) **43** privremeni smještaj; pružanje hrane i pića; usluge informiranja, savjetovanja i rezervacija u vezi opskrbe hranom i pićem; usluge pružanja informacija, savjetovanja i rezervacija u vezi privremenog smještaja; pružanje privremenog smještaja; usluge privremenog smještaja

(111) **Z20230623** (151) 11.03.2024.  
(450) 15.03.2024.  
(210) Z20230623A (220) 26.06.2023.  
(181) **26.06.2033.**

(732) **BOCCA PORTA j.d.o.o.**  
Dolinka 18, 52100 Pula, HR  
(740) Aleksandar Puh, Pula, HR  
(540)



(591) plava, žuta, bijela  
(531) 17.02.17; 27.05.01; 27.05.09; 27.05.10; 27.05.24  
(511)

**43** privremeni smještaj; pružanje hrane i pića; usluge informiranja, savjetovanja i rezervacija u vezi opskrbe hranom i pićem; usluge pružanja informacija, savjetovanja i rezervacija u vezi privremenog smještaja; pružanje privremenog smještaja; usluge privremenog smještaja

(111) **Z20230927** (151) 08.03.2024.  
(450) 15.03.2024.  
(210) Z20230927A (220) 28.09.2023.  
(181) **28.09.2033.**

(732) **SOI FUSION d.o.o. za usluge**  
Ilica 50, 10000 Zagreb, HR  
(740) Bojan Čobanić, Zagreb, HR  
(540)

## SOI

(511) **43** usluge okrepe (pružanje hrane i pića); priprema hrane i pića; pružanje usluga prehrane; usluge restorana; usluge bistroa; pružanje privremenog smještaja



**RAZRED 44**

(111)	<b>Z20230505</b>	(151)	07.03.2024.
		(450)	15.03.2024.
(210)	Z20230505A	(220)	18.05.2023.
		(181)	<b>18.05.2033.</b>
(732)	<b>HRVATSKA UDRUGA MEDICINSKIH SESTARA</b>		
	Sortina 1A, 10000 Zagreb, HR		
(740)	Borna Okroša, Zagreb, HR		
(540)			



(591)	crvena, plava, siva
(531)	26.02.01; 26.02.12; 26.02.16; 26.02.19; 27.05.01; 27.05.25; 29.01.01; 29.01.04; 29.01.06
(511)	<b>44</b> medicinska pomoć

(111)	<b>Z20230506</b>	(151)	07.03.2024.
		(450)	15.03.2024.
(210)	Z20230506A	(220)	18.05.2023.
		(181)	<b>18.05.2033.</b>
(732)	<b>HRVATSKA UDRUGA MEDICINSKIH SESTARA</b>		
	Sortina 1A, 10000 Zagreb, HR		
(740)	Borna Okroša, Zagreb, HR		
(540)			



(591)	plava, crvena, siva
(531)	26.02.01; 26.02.12; 26.02.16; 26.02.19; 29.01.01; 29.01.04; 29.01.06
(511)	<b>44</b> medicinska pomoć

(111)	<b>Z20230802</b>	(151)	27.02.2024.
		(450)	15.03.2024.
(210)	Z20230802A	(220)	24.08.2023.
		(181)	<b>24.08.2033.</b>
(732)	<b>DRVOPLAST d.d.</b>		
	Ivana Sancina 3, 52420 Buzet, HR		
(540)			



(591)	zelena, plava
(531)	01.15.17; 07.03.11; 26.11.02; 26.11.05; 26.11.09; 26.03.23; 27.05.10
(511)	<b>44</b> uzgoj biljaka; uzgoj usjeva

# Kazalo brojeva žigova

Broj žiga (111)	Klasifikacijska oznaka razreda (511)	Broj žiga (111)	Klasifikacijska oznaka razreda (511)
Z20200330	1, 2, 3, 5, 6, 7, 8, 9, 11, 12, 16, 19, 20, 21, 22, 31, 35, 36, 37, 39	Z20230797	25, 32, 35, 39
Z20230108	35, 42	Z20230798	25, 32, 35, 39
Z20230214	35	Z20230799	35, 39, 41, 43
Z20230505	44	Z20230800	35, 39, 41, 43
Z20230506	44	Z20230801	35, 39, 41, 43
Z20230541	4, 39, 42, 43	Z20230802	44
Z20230552	9, 42	Z20230840	11, 30, 43
Z20230555	35, 41, 43	Z20230843	16, 35, 38, 39, 40
Z20230585	9	Z20230844	16, 35, 38, 39, 40
Z20230591	36	Z20230845	30, 43
Z20230616	43	Z20230849	33
Z20230617	43	Z20230852	20, 28
Z20230618	43	Z20230854	32
Z20230619	43	Z20230856	29
Z20230623	43	Z20230857	29
Z20230625	35, 41, 42	Z20230858	29
Z20230629	19, 21, 40	Z20230860	41
Z20230691	16, 17, 39, 42	Z20230863	5
Z20230712	9	Z20230864	5
Z20230715	16, 17	Z20230867	5
Z20230753	5, 30, 32	Z20230868	5
Z20230757	29, 31, 39	Z20230869	3, 5
Z20230760	5	Z20230872	28
Z20230762	35, 42	Z20230873	28
Z20230769	31	Z20230874	28
Z20230778	29, 30	Z20230887	9, 35
Z20230785	35, 39, 41, 43	Z20230895	30
Z20230786	35, 39, 41, 43	Z20230900	9, 42, 44
Z20230788	6, 9, 19	Z20230901	35, 38, 39, 41, 43, 44
Z20230795	35, 39, 41, 43	Z20230902	35, 38, 39, 41, 43, 44
Z20230796	35, 39, 41, 43		

Broj žiga (111)	Klasifikacijska oznaka razreda (511)	Broj žiga (111)	Klasifikacijska oznaka razreda (511)
Z20230903	35, 38, 39, 41, 43, 44	Z20230921	5
Z20230904	35, 38, 39, 41, 43, 44	Z20230923	6, 9, 19
Z20230905	41	Z20230927	43
Z20230915	16, 18, 21, 24, 25, 27, 28, 41	Z20230929	30, 35, 41
Z20230916	16, 18, 21, 24, 25, 27, 28, 41	Z20230936	34

# Kazalo klasifikacijskih oznaka žigova

Klasifikacijska oznaka razreda(511);Nositelj žiga(732)	Broj žiga(111)	Klasifikacijska oznaka razreda(511);Nositelj žiga(732)	Broj žiga(111)
<b>RAZRED 1</b>		<b>RAZRED 12</b>	
PEVEX maloprodaja neprehrambene robe dioničko društvo .....	Z20200330	PEVEX maloprodaja neprehrambene robe dioničko društvo .....	Z20200330
<b>RAZRED 2</b>		<b>RAZRED 16</b>	
PEVEX maloprodaja neprehrambene robe dioničko društvo .....	Z20200330	HP - Hrvatska pošta d.d. ....	Z20230843, Z20230844
<b>RAZRED 3</b>		HRVATSKI GOLF SAVEZ .....	Z20230915, Z20230916
KERN PHARMA, S.L. ....	Z20230869	Modepack d.o.o. ....	Z20230691, Z20230715
PEVEX maloprodaja neprehrambene robe dioničko društvo .....	Z20200330	PEVEX maloprodaja neprehrambene robe dioničko društvo .....	Z20200330
<b>RAZRED 4</b>		<b>RAZRED 17</b>	
Calima Engineering d.o.o. ....	Z20230541	Modepack d.o.o. ....	Z20230691, Z20230715
<b>RAZRED 5</b>		<b>RAZRED 18</b>	
ALKALOID AD Skopje .....	Z20230760, Z20230863, Z20230864	HRVATSKI GOLF SAVEZ .....	Z20230915, Z20230916
ATLANTIC CEDEVITA d.o.o. ....	Z20230753	<b>RAZRED 19</b>	
BGP Products Operations GmbH .....	Z20230921	Percan Mladen .....	Z20230629
KERN PHARMA, S.L. ....	Z20230867, Z20230868, Z20230869	PEVEX maloprodaja neprehrambene robe dioničko društvo .....	Z20200330
PEVEX maloprodaja neprehrambene robe dioničko društvo .....	Z20200330	Trinapower Co., Ltd. ....	Z20230923
<b>RAZRED 6</b>		Trinapower Co., Ltd. ....	Z20230788
PEVEX maloprodaja neprehrambene robe dioničko društvo .....	Z20200330	<b>RAZRED 20</b>	
Trinapower Co., Ltd. ....	Z20230923	PEVEX maloprodaja neprehrambene robe dioničko društvo .....	Z20200330
Trinapower Co., Ltd. ....	Z20230788	Stepanchenko Anton .....	Z20230852
<b>RAZRED 7</b>		<b>RAZRED 21</b>	
PEVEX maloprodaja neprehrambene robe dioničko društvo .....	Z20200330	HRVATSKI GOLF SAVEZ .....	Z20230915, Z20230916
<b>RAZRED 8</b>		Percan Mladen .....	Z20230629
PEVEX maloprodaja neprehrambene robe dioničko društvo .....	Z20200330	PEVEX maloprodaja neprehrambene robe dioničko društvo .....	Z20200330
<b>RAZRED 9</b>		<b>RAZRED 22</b>	
ADNET d.o.o. ....	Z20230712	PEVEX maloprodaja neprehrambene robe dioničko društvo .....	Z20200330
E-GLAS d.o.o. ....	Z20230900	<b>RAZRED 24</b>	
Kia Corporation .....	Z20230585	HRVATSKI GOLF SAVEZ .....	Z20230915, Z20230916
Moberg d.o.o. ....	Z20230887	<b>RAZRED 25</b>	
PEVEX maloprodaja neprehrambene robe dioničko društvo .....	Z20200330	CARLSBERG CROATIA društvo s ograničenom odgovornošću .....	Z20230797, Z20230798
POSLOVNA INTELIGENCIJA d.o.o. za dizajn i implementaciju inteligentnih informacijskih sustava .....	Z20230552	HRVATSKI GOLF SAVEZ .....	Z20230915, Z20230916
Trinapower Co., Ltd. ....	Z20230923	<b>RAZRED 27</b>	
Trinapower Co., Ltd. ....	Z20230788	HRVATSKI GOLF SAVEZ .....	Z20230915, Z20230916
<b>RAZRED 11</b>		<b>RAZRED 28</b>	
PEVEX maloprodaja neprehrambene robe dioničko društvo .....	Z20200330	HRVATSKI GOLF SAVEZ .....	Z20230915, Z20230916
Volim Ljuto j.d.o.o. ....	Z20230840	Stepanchenko Anton .....	Z20230852
		TECHNOSMART j.d.o.o. ....	Z20230872, Z20230873, Z20230874
		<b>RAZRED 29</b>	
		CLARUM d.o.o. ....	Z20230778

Klasifikacijska oznaka razreda(511);Nositelj žiga(732)	Broj žiga(111)	Klasifikacijska oznaka razreda(511);Nositelj žiga(732)	Broj žiga(111)
ORADA ADRIATIC d.o.o. ....	Z20230757	<b>RAZRED 38</b>	
PIK VRBOVEC plus d.o.o. ....	Z20230856, Z20230857	HP - Hrvatska pošta d.d. ....	Z20230843, Z20230844
.....	Z20230858	REMISENS HOTEL GROUP d.o.o. ....	Z20230901, Z20230902
<b>RAZRED 30</b>		.....	Z20230903, Z20230904
ATLANTIC CEDEVITA d.o.o. ....	Z20230753	<b>RAZRED 39</b>	
BOBIS d.o.o. ....	Z20230895	Calima Engineering d.o.o. ....	Z20230541
CLARUM d.o.o. ....	Z20230778	CARLSBERG CROATIA društvo s	
PEKARNA STARI ZAGREB d.o.o. ....	Z20230845	ograničenom odgovornošću.....	Z20230797, Z20230798
UDRUGA ŽENA MARUŠA,		DENTON ADRIA d.o.o. ....	Z20230785, Z20230786
MARUŠEVEC.....	Z20230929	.....	Z20230795, Z20230796
Volim Ljuto j.d.o.o. ....	Z20230840	.....	Z20230799, Z20230800
<b>RAZRED 31</b>		.....	Z20230801
BİBERCİLER İÇ DIŞ GIDA		HP - Hrvatska pošta d.d. ....	Z20230843, Z20230844
MADDELERİ PAZARLAMA TİCARET		Modepack d.o.o. ....	Z20230691
LIMITED ŞİRKETİ .....	Z20230769	ORADA ADRIATIC d.o.o. ....	Z20230757
ORADA ADRIATIC d.o.o. ....	Z20230757	PEVEX maloprodaja neprehrambene	
PEVEX maloprodaja neprehrambene		robe dioničko društvo .....	Z20200330
robe dioničko društvo.....	Z20200330	REMISENS HOTEL GROUP d.o.o. ....	Z20230901, Z20230902
<b>RAZRED 32</b>		.....	Z20230903, Z20230904
ATLANTIC CEDEVITA d.o.o. ....	Z20230753	<b>RAZRED 40</b>	
CARLSBERG CROATIA društvo s		HP - Hrvatska pošta d.d. ....	Z20230843, Z20230844
ograničenom odgovornošću.....	Z20230797, Z20230798	Percan Mladen .....	Z20230629
Ličanka proizvodnja pića d.o.o. ....	Z20230854	<b>RAZRED 41</b>	
<b>RAZRED 33</b>		DENTON ADRIA d.o.o. ....	Z20230785, Z20230786
KONZUM plus društvo s ograničenom		.....	Z20230795, Z20230796
odgovornošću za trgovinu.....	Z20230849	.....	Z20230799, Z20230800
<b>RAZRED 34</b>		.....	Z20230801
Dunhill Tobacco of London Limited .....	Z20230936	Hadaš Dejvid.....	Z20230905
<b>RAZRED 35</b>		HRVATSKI GOLF SAVEZ .....	Z20230915, Z20230916
CARLSBERG CROATIA društvo s		Najcer Antun .....	Z20230555
ograničenom odgovornošću.....	Z20230797, Z20230798	PARVE d.o.o. ....	Z20230860
CHECKSUM d.o.o. ....	Z20230762	Purgarić Davorin.....	Z20230625
DENTON ADRIA d.o.o. ....	Z20230785, Z20230786	REMISENS HOTEL GROUP d.o.o. ....	Z20230901, Z20230902
.....	Z20230795, Z20230796	.....	Z20230903, Z20230904
.....	Z20230799, Z20230800	UDRUGA ŽENA MARUŠA,	
.....	Z20230801	MARUŠEVEC .....	Z20230929
HAKL SPORT d.o.o. ....	Z20230108	<b>RAZRED 42</b>	
HP - Hrvatska pošta d.d. ....	Z20230843, Z20230844	Calima Engineering d.o.o. ....	Z20230541
Jurić-Kačunić Ivan .....	Z20230214	CHECKSUM d.o.o. ....	Z20230762
Moberg d.o.o. ....	Z20230887	E-GLAS d.o.o. ....	Z20230900
Najcer Antun .....	Z20230555	HAKL SPORT d.o.o. ....	Z20230108
PEVEX maloprodaja neprehrambene		Modepack d.o.o. ....	Z20230691
robe dioničko društvo.....	Z20200330	POSLOVNA INTELIGENCIJA d.o.o. za	
Purgarić Davorin.....	Z20230625	dizajn i implementaciju inteligentnih	
REMISENS HOTEL GROUP d.o.o. ....	Z20230901, Z20230902	informacijskih sustava .....	Z20230552
.....	Z20230903, Z20230904	Purgarić Davorin.....	Z20230625
UDRUGA ŽENA MARUŠA,		<b>RAZRED 43</b>	
MARUŠEVEC.....	Z20230929	BOCCA PORTA j.d.o.o. ....	Z20230616, Z20230617
<b>RAZRED 36</b>		.....	Z20230618, Z20230619
Kia Corporation .....	Z20230591	.....	Z20230623
PEVEX maloprodaja neprehrambene		Calima Engineering d.o.o. ....	Z20230541
robe dioničko društvo.....	Z20200330	DENTON ADRIA d.o.o. ....	Z20230785, Z20230786
<b>RAZRED 37</b>		.....	Z20230795, Z20230796
PEVEX maloprodaja neprehrambene		.....	Z20230799, Z20230800
robe dioničko društvo.....	Z20200330	.....	Z20230801
		Najcer Antun .....	Z20230555
		PEKARNA STARI ZAGREB d.o.o. ....	Z20230845
		REMISENS HOTEL GROUP d.o.o. ....	Z20230901, Z20230902
		.....	Z20230903, Z20230904
		SOI FUSION d.o.o. za usluge.....	Z20230927
		Volim Ljuto j.d.o.o. ....	Z20230840

Klasifikacijska oznaka razreda(511);Nositelj žiga(732) Broj žiga(111)

Klasifikacijska oznaka razreda(511);Nositelj žiga(732) Broj žiga(111)

**RAZRED 44**

DRVOPLAST d.d..... Z20230802  
E-GLAS d.o.o..... Z20230900  
HRVATSKA UDRUGA MEDICINSKIH  
SESTARA ..... Z20230505, Z20230506

REMISENS HOTEL GROUP d.o.o. .... Z20230901, Z20230902  
..... Z20230903, Z20230904

## Kazalo nositelja žigova

Nositelj žiga (732)	Broj žiga (111)	Nositelj žiga (732)	Broj žiga (111)
ADNET d.o.o.	Z20230712	Kia Corporation	Z20230585, Z20230591
ALKALOID AD Skopje	Z20230760, Z20230863 Z20230864	KONZUM plus društvo s ograničenom odgovornošću za trgovinu	Z20230849
ATLANTIC CEDEVITA d.o.o.	Z20230753	Ličanka proizvodnja pića d.o.o.	Z20230854
BGP Products Operations GmbH	Z20230921	Moberg d.o.o.	Z20230887
BİBERCİLER İÇ DIŞ GIDA MADDELERİ PAZARLAMA TİCARET LİMİTED ŞİRKETİ	Z20230769	Modepack d.o.o.	Z20230691, Z20230715
BOBIS d.o.o.	Z20230895	Najcer Antun	Z20230555
BOCCA PORTA j.d.o.o.	Z20230616, Z20230617 Z20230618, Z20230619 Z20230623	ORADA ADRIATIC d.o.o.	Z20230757
Calima Engineering d.o.o.	Z20230541	PARVE d.o.o.	Z20230860
CARLSBERG CROATIA društvo s ograničenom odgovornošću	Z20230797, Z20230798	PEKARNA STARI ZAGREB d.o.o.	Z20230845
CHECKSUM d.o.o.	Z20230762	Percan Mladen	Z20230629
CLARUM d.o.o.	Z20230778	PEVEX maloprodaja neprehrambene robe dioničko društvo	Z20200330
DENTON ADRIA d.o.o.	Z20230785, Z20230786 Z20230795, Z20230796 Z20230799, Z20230800 Z20230801	PIK VRBOVEC plus d.o.o.	Z20230856, Z20230857 Z20230858
DRVOPLAST d.d.	Z20230802	POSLOVNA INTELIGENCIJA d.o.o. za dizajn i implementaciju inteligentnih informacijskih sustava	Z20230552
Dunhill Tobacco of London Limited	Z20230936	Purgarić Davorin	Z20230625
E-GLAS d.o.o.	Z20230900	REMISENS HOTEL GROUP d.o.o.	Z20230901, Z20230902 Z20230903, Z20230904
Hadaš Dejvid	Z20230905	SOI FUSION d.o.o. za usluge	Z20230927
HAKL SPORT d.o.o.	Z20230108	Stepanchenko Anton	Z20230852
HP - Hrvatska pošta d.d.	Z20230843, Z20230844	TECHNOSMART j.d.o.o.	Z20230872, Z20230873 Z20230874
HRVATSKA UDRUGA MEDICINSKIH SESTARA	Z20230505, Z20230506	Trinapower Co., Ltd.	Z20230923
HRVATSKI GOLF SAVEZ	Z20230915, Z20230916	Trinapower Co., Ltd.	Z20230788
Jurić-Kačunić Ivan	Z20230214	UDRUGA ŽENA MARUŠA, MARUŠEVEC	Z20230929
KERN PHARMA, S.L.	Z20230867, Z20230868 Z20230869	Volim Ljuto j.d.o.o.	Z20230840

# Objava upisa promjena u Registru žigova

## Promjena adrese nositelja žiga

Broj žiga (111)	Raniji zapis (771)	Novi zapis (732)	Datum upisa promjene (580)
Ž940425	BAXI HEATING UK LIMITED, Pentagon House, Sir Frank Whittle Road, Derby, GB	BAXI HEATING UK LIMITED, Brooks House, Coventry Road, Warwickshire, CV34 4LL Warwick, GB	28.02.2024
Z20040277	COMMAX Co., Ltd., 513-11, Sangdaewon-Dong, Jungwon-Gu, Sungnam-Si, Kyunggi-Do, 462-120, KR	COMMAX Co., Ltd., 494, Dunchon-daero, Jungwon-gu, Seongnam-si, Gyeonggi-do, KR	28.02.2024
Z20040438	HONEYWELL International Inc., 101 Columbia Road, Morristown, NJ, US	Honeywell International Inc., 855 S. Mint Street, Charlotte, NC 28202, US	29.02.2024
Z20040661	Intervet Inc., 2 Giralda Farms, Madison, NJ 07940, US	Intervet Inc., 126 East Lincoln Avenue, Rahway, NJ 07065, US	29.02.2024
Z20140227	OLX B.V., Taurusavenue 105, 2132 LS Hoofddorp, NL	OLX B.V., Symphony Offices, Gustav Mahlerplein 5, 1082 MS Amsterdam, NL	28.02.2024
Z20140249	PICKBOX d.o.o., Radnička cesta 50, 10000 Zagreb, HR	PICKBOX d.o.o., Radnička cesta 52, 10000 Zagreb, HR	28.02.2024
Z20140250	PICKBOX d.o.o., Radnička cesta 50, 10000 Zagreb, HR	PICKBOX d.o.o., Radnička cesta 52, 10000 Zagreb, HR	28.02.2024
Z20140288	HERBAFARM-MAGNOLIJA d.o.o., Trnsko 23, 10000 Zagreb, HR	HERBAFARM-MAGNOLIJA d.o.o., Ulica Antuna Vramca 10, 10000 Zagreb, HR	08.03.2024
Z20140515	Hrvatski Telekom d.d., Roberta Frangeša Mihanovića 9, 10000 Zagreb, HR	Hrvatski Telekom d.d., Radnička cesta 21, 10000 Zagreb, HR	29.02.2024
Z20140720	Hrvatski Telekom d.d., Roberta Frangeša Mihanovića 9, 10000 Zagreb, HR	Hrvatski Telekom d.d., Radnička cesta 21, 10000 Zagreb, HR	29.02.2024
Z20140721	Hrvatski Telekom d.d., Roberta Frangeša Mihanovića 9, 10000 Zagreb, HR	Hrvatski Telekom d.d., Radnička cesta 21, 10000 Zagreb, HR	04.03.2024
Z20141080	Hrvatski Telekom d.d., Roberta Frangeša Mihanovića 9, 10000 Zagreb, HR	Hrvatski Telekom d.d., Radnička cesta 21, 10000 Zagreb, HR	28.02.2024
Z20141081	Hrvatski Telekom d.d., Roberta Frangeša Mihanovića 9, 10000 Zagreb, HR	Hrvatski Telekom d.d., Radnička cesta 21, 10000 Zagreb, HR	29.02.2024
Z20200332	ULTRA LINK d.o.o., Bolnička cesta 54, 10000 Zagreb, HR	ULTRA LINK d.o.o., Jagnedje 1, 10000 Zagreb, HR	05.03.2024
Z20210846	CUTTING EDGE VENTURES LIMITED, P.O.Box 1239 Offshore Incorporations Centre, Victoria, Mahe, SC	CUTTING EDGE VENTURES LIMITED, Trust Company Complex, Ajeltake Road, Ajeltake Island, Majuro, 96960 Marshall Islands, MH	28.02.2024
Z20210847	CUTTING EDGE VENTURES LIMITED, P.O.Box 1239 Offshore Incorporations Centre, Victoria, Mahe, SC	CUTTING EDGE VENTURES LIMITED, Trust Company Complex, Ajeltake Road, Ajeltake Island, 96960 Majuro, MH	28.02.2024

## Promjena imena nositelja žiga

Broj žiga (111)	Raniji zapis (771)	Novi zapis (732)	Datum upisa promjene (580)
Z20140352	Zavod za javno zdravstvo "Dr. Andrija Štampar", Mirogojska cesta 16, 10000 Zagreb, HR	Nastavni zavod za javno zdravstvo "Dr. Andrija Štampar", Mirogojska cesta 16, 10000 Zagreb, HR	11.03.2024
Z20140492	Irvida Plant Protection N.V., Pos Cabai Office Park Unit 13, Curacao, CW	ADAMA IRVITA N.V., Pos Cabai Office Park Unit 13, Curacao, CW	04.03.2024

## Prijenos prava

Broj žiga (111)	Raniji zapis (770)	Novi zapis (732)	Datum upisa promjene (580)
Ž933742	HIDROIZOLACIJA KATRAN d.o.o., Radnička cesta 27, 10000 Zagreb, HR	DRACO d.o.o., Draškovićeve 4, 21210 Solin, HR	26.02.2024
Ž934121	HIDROIZOLACIJA KATRAN d.o.o., Radnička cesta 27, 10000 Zagreb, HR	DRACO d.o.o., Draškovićeve 4, 21210 Solin, HR	26.02.2024
Ž934135	HIDROIZOLACIJA KATRAN d.o.o., Radnička cesta 27, 10000 Zagreb, HR	DRACO d.o.o., Draškovićeve 4, 21210 Solin, HR	26.02.2024
Ž934136	HIDROIZOLACIJA KATRAN d.o.o., Radnička cesta 27, 10000 Zagreb, HR	DRACO d.o.o., Draškovićeve 4, 21210 Solin, HR	26.02.2024
Ž934137	HIDROIZOLACIJA KATRAN d.o.o., Radnička cesta 27, 10000 Zagreb, HR	DRACO d.o.o., Draškovićeve 4, 21210 Solin, HR	26.02.2024



Broj žiga (111)	Raniji zapis (770)	Novi zapis (732)	Datum upisa promjene (580)
Ž934138	HIDROIZOLACIJA KATRAN d.o.o., Radnička cesta 27, 10000 Zagreb, HR	DRACO d.o.o., Draškovićeve 4, 21210 Solin, HR	26.02.2024
Ž934139	HIDROIZOLACIJA KATRAN d.o.o., Radnička cesta 27, 10000 Zagreb, HR	DRACO d.o.o., Draškovićeve 4, 21210 Solin, HR	26.02.2024
Z20000866	HIDROIZOLACIJA KATRAN d.o.o., Radnička cesta 27, 10000 Zagreb, HR	DRACO d.o.o., Draškovićeve 4, 21210 Solin, HR	27.02.2024
Z20131685	HIDROIZOLACIJA KATRAN d.o.o. za proizvodnju, trgovinu i usluge, Radnička cesta 27, 10000 Zagreb, HR	DRACO d.o.o., Draškovićeve 4, 21210 Solin, HR	27.02.2024
Z20131686	HIDROIZOLACIJA KATRAN d.o.o. za proizvodnju, trgovinu i usluge, Radnička cesta 27, 10000 Zagreb, HR	DRACO d.o.o., Draškovićeve 4, 21210 Solin, HR	27.02.2024
Z20131687	HIDROIZOLACIJA KATRAN d.o.o. za proizvodnju, trgovinu i usluge, Radnička cesta 27, 10000 Zagreb, HR	DRACO d.o.o., Draškovićeve 4, 21210 Solin, HR	27.02.2024
Z20131688	HIDROIZOLACIJA KATRAN d.o.o. za proizvodnju, trgovinu i usluge, Radnička cesta 27, 10000 Zagreb, HR	DRACO d.o.o., Draškovićeve 4, 21210 Solin, HR	27.02.2024
Z20131689	HIDROIZOLACIJA KATRAN d.o.o. za proizvodnju, trgovinu i usluge, Radnička cesta 27, 10000 Zagreb, HR	DRACO d.o.o., Draškovićeve 4, 21210 Solin, HR	27.02.2024
Z20170661	FCR MEDIA ONLINE d.o.o., Čnomerec 3, 10000 Zagreb, HR	FCR MEDIA ON LINE S.R.L., 319 Splaiul Independentei street, 6th District, Bukurešt, RO	11.03.2024
Z20170662	FCR MEDIA ONLINE d.o.o., Čnomerec 3, 10000 Zagreb, HR	FCR MEDIA ON LINE S.R.L., 319 Splaiul Independentei street, 6th District, Bukurešt, RO	11.03.2024
Z20191325	SEDAM IT d.o.o. PRIMJENA INFORMATIČKIH TEHNOLOGIJA, Koledovčina 2, 10000 Zagreb, HR	7 PAYMENTS d.o.o. za računalne i srodne djelatnosti, Koledovčina 2, 10000 Zagreb, HR	28.02.2024
Z20220325	EcoCipela d.o.o., Ote Horvata 7, 33000 Virovitica, HR	ECO VIR d.o.o., Istarska 6, 52470 Umag, HR	28.02.2024
Z20220557	SEDAM IT d.o.o., Koledovčina 2, 10000 Zagreb, HR	7 PAYMENTS d.o.o. za računalne i srodne djelatnosti, Koledovčina 2, 10000 Zagreb, HR	28.02.2024

**Djelomičan prijenos prava**

Broj novog žiga (111)	Broj izvornog žiga (646)	Datum objave izvornog žiga (450)	Novi zapis (732)	Preneseni popisi (511)	Datum upisa promjene (580)
Z20240217	Z20091885	30.11.2010	LUXOR 2 d.o.o., Put Majdana 43A, 21210 Solin, HR	29 hladetina (želei), džemovi, kompoti 30 kava, čaj, kakao i nadomjesci kave; brašno i proizvodi od žitarica, kruh, kolači, slastice; sladoled; med, sirup od melase 32 pivo, mineralne i gazirane vode te ostala bezalkoholna pića; voćni napici i voćni sokovi; sirupi i ostali preparati za pripremanje napitaka	05.03.2024

**Ograničenje popisa proizvoda i usluga**

Broj žiga (111)	Datum objave žiga (450)	Popis proizvoda i usluga za koje žig nastavlja vrijediti (511)	Datum upisa promjene (580)
Z20091885	30.11.2010	29 meso, riba, perad i divljač; mesni ekstrakti; konzervirano, sušeno i kuhano voće i povrće; jaja, mlijeko i mliječni proizvodi; jestiva ulja i masti 30 riža, tapioka, sago, bomboni; kvasac, prašak za dizanje; sol, slačica (senf); ocat, umaci (začini); mirodije	06.03.2024
Z20140337	26.09.2014	35 oglašavanje i reklamiranje; vođenje komercijalnih poslova; komercijalna administracija; uredski poslovi; posebno, marketing; konzultantske usluge u svezi marketinga; predstavljanje proizvoda; proučavanje tržišta; stručne poslovne konzultacije; istraživanje javnog mijenja; usluge nabave za treće; izdavanje i objavljivanje reklamnih materijala; savjetovanje u svezi poslovanja poduzeća 42 znanstvene i tehnološke usluge kao i pripadajuće usluge istraživanja i koncepcije; usluge industrijskih analiza i istraživanja; koncepcija i razvoj računala i računalnih programa; posebno arhitektura; industrijski dizajn; industrijsko oblikovanje; usluga modnih dizajnera; urbano planiranje; usluga crtača ambalaže; grafička umjetnost; istraživanje i razvoj novih proizvoda za treće; unutarnje uređenje (dekoracija); izrada tehničkih projekata	06.03.2024

**Brisanje zaloga**

Broj žiga (111)	Založni vjerovnik (zalagoprimac)	Nositelj žiga (zalagodavac) (732)	Datum brisanja založnog prava (580)
Z20200332	BKS Bank AG, St. Veiter Ring 43, 9020 Klagenfurt, AT	ULTRA LINK d.o.o., Bolnička cesta 54, 10000 Zagreb, HR	05.03.2024
Z20200332	BKS Bank AG, St. Veiter Ring 43, 9020 Klagenfurt, AT	ULTRA LINK d.o.o., Bolnička cesta 54, 10000 Zagreb, HR	05.03.2024

# Objava ispravaka podataka iz objavljenih žigova

U rješenju o upisu promjene od 12. prosinca 2023. godine, izdanom na ime nositelja žiga World Wrestling Entertainment, LLC, 707 Washington Blvd., CT 06901, US, ispravlja se slijedeća pogreška:

Adresa podnositelja World Wrestling Entertainment, LLC, 707 Washington Blvd., CT 06901, US, ispravlja se u točnu adresu:

707 Washington Blvd., Stamford CT 06901, US.

U rješenju o upisu promjene od 12. prosinca 2023. godine, izdanom na ime nositelja žiga World Wrestling Entertainment, LLC, 707 Washington Blvd., CT 06901, US, ispravlja se slijedeća pogreška:

Adresa podnositelja World Wrestling Entertainment, LLC, 707 Washington Blvd., CT 06901, US, ispravlja se u točnu adresu:

707 Washington Blvd., Stamford CT 06901, US.

# Objava produženja vrijednosti registracija žigova

Broj žiga	Klasifikacijska oznaka razreda	Ime i adresa nositelja žiga	Datum podnošenja zahtjeva za produženje žiga	Datum do kojeg vrijedi produženje žiga (186)
(111)	(511)	(732)		
Ž921023	9	Techtronic Cordless GP, 100 Innovation Way, Anderson, SC 29621, US	08.12.2023	01.02.2034
Ž922140	30	Intercontinental Great Brands LLC, 100 Deforest Avenue, East Hanover, NJ 07936, US	23.02.2024	22.04.2034
Ž922141	30	Intercontinental Great Brands LLC, 100 Deforest Avenue, East Hanover, NJ 07936, US	23.02.2024	22.04.2034
Ž940155	3	THE POLO/LAUREN COMPANY, L.P., 650 Madison Avenue, New York, NY 10022, US	29.12.2023	24.01.2034
Ž940255	5	OMS Investments, Inc., 10250 Constellation Boulevard, Suite 2800, Los Angeles, CA 90067, US	28.02.2024	06.02.2034
Ž940812	1	PETROKEMIJA d.d., Aleja Vukovar 4, 44320 Kutina, HR	23.02.2024	31.03.2034
Ž940841	25	Perry Ellis International Group Holdings Limited, Montague Sterling Center, 5th Floor, East Bay Street, Nassau, BS	19.02.2024	31.03.2034
Ž940875	1	PETROKEMIJA d.d., Aleja Vukovar 4, 44320 Kutina, HR	23.02.2024	07.04.2034
Ž940931	25	MONCLER S.P.A., Via Stendhal 47, 20144 Milano, IT	27.02.2024	15.04.2034
Ž940932	30	Kraft Foods Danmark Intellectual Property ApS, Ringager 2 A, 2, 2605 Brøndby, DK	23.02.2024	15.04.2034
Ž940945	6, 9, 17, 21	Panasonic Holdings Corporation, 1006, Oaza Kadoma, Kadoma-shi, 571-8501 Osaka, JP	23.02.2024	15.04.2034
Ž940950	28, 41	Califon Productions, Inc., a California corporation, 10202 West Washington Blvd., Culver City, CA 90232, US	22.02.2024	18.04.2034
Ž940995	25	The B.V.D. Licensing Corporation, One Fruit of the Loom Drive, Bowling Green 42103, KY, US	01.03.2024	22.04.2034
Ž940996	25	Fruit of the Loom, Inc., One Fruit of the Loom Drive, P.O.Box 90015, Bowling Green 42102-9015, KY, US	01.03.2024	22.04.2034
Ž941001	30	Cadbury UK Limited, P. O. Box 12, Bournville Lane, Bournville, B30 2LU Birmingham, GB	27.02.2024	25.04.2034
Ž941003	30	Cadbury UK Limited, P. O. Box 12, Bournville Lane, Bournville, B30 2LU Birmingham, GB	27.02.2024	25.04.2034
Ž941004	30	Cadbury UK Limited, P. O. Box 12, Bournville Lane, Bournville, B30 2LU Birmingham, GB	27.02.2024	25.04.2034
Ž941005	30	Cadbury UK Limited, P. O. Box 12, Bournville Lane, Bournville, B30 2LU Birmingham, GB	27.02.2024	25.04.2034
Ž941013	9	Teac Corporation, 3-7-3, Naka-Cho, Musashino-Shi, Tokyo, JP	23.02.2024	25.04.2034
Ž941036	5	FMC Agricultural Caribe Industries, Ltd., Clarendon House, 2 Church Street, HM11 Hamilton, BM	28.02.2024	27.04.2034
Ž941114	30	Cadbury UK Limited, P. O. Box 12, Bournville Lane, Bournville, B30 2LU Birmingham, GB	27.02.2024	16.05.2034
Ž941118	30	Cadbury UK Limited, PO Box 12, Bournville Lane, Bournville, B30 2LU Birmingham, GB	27.02.2024	16.05.2034
Ž991066	30	Intercontinental Great Brands LLC, 100 Deforest Avenue, East Hanover, NJ 07936, US	23.02.2024	22.04.2034
Z20040082	35	JC New Retail AG, Innere Güterstrasse 2, 6300 Zug, CH	18.12.2023	20.01.2034
Z20040277	9	COMMAX Co., Ltd., 494, Dunchon-daero, Jungwon-gu, Seongnam-si, Gyeonggi-do, KR	16.02.2024	20.02.2034
Z20040319	4, 12, 25	VER d.o.o. za trgovinu na veliko i malo i uvoz-izvoz, Mate Lovraka 1, 10410 Velika Gorica, HR	13.02.2024	01.03.2034
Z20040438	9, 38, 42	Honeywell International Inc., 855 S. Mint Street, Charlotte, NC 28202, US	23.02.2024	15.03.2034
Z20040447	5	JADRAN-GALENSKI LABORATORIJ d.d., Svilno 20, 51000 Rijeka, HR	28.02.2024	18.03.2034
Z20040449	5	JADRAN-GALENSKI LABORATORIJ d.d., Svilno 20, 51000 Rijeka, HR	28.02.2024	18.03.2034
Z20040454	16, 25, 35	ANCORIS d.o.o., Pasjak 61, 51214 Šapjane, HR	22.02.2024	18.03.2034
Z20040499	25	SURF CO LTDA, Rua Guaianazes 1448, Sao Paulo, BR	20.02.2024	25.03.2034
Z20040538	5, 35, 44	Berlin-Chemie AG, Glienicke Weg 125, 12489 Berlin, DE	05.03.2024	31.03.2034
Z20040539	5, 35, 44	Berlin-Chemie AG, Glienicke Weg 125, 12489 Berlin, DE	05.03.2024	31.03.2034
Z20040565	20, 21, 27	LES-MMS trgovska družba d.o.o., Cesta na Bokalce 40, 1000 Ljubljana, SI	06.03.2024	06.04.2034
Z20040609	23	HYOSUNG TNC CORPORATION, 119 (Gongdeok-dong), Mapo-daero, Mapo-gu, Seoul, KR	27.02.2024	15.04.2034

## HR - Hrvatski glasnik intelektualnog vlasništva 31, 6/2024 - ŽIGOVI

Broj žiga	Klasifikacijska oznaka razreda	Ime i adresa nositelja žiga	Datum podnošenja zahtjeva za produženje žiga	Datum do kojeg vrijedi produženje žiga (186)
(111)	(511)	(732)		
Z20040661	5	Intervet Inc., 126 East Lincoln Avenue, Rahway, NJ 07065, US	29.01.2024	26.04.2034
Z20040810	29	SAVENCIA SA, 42 rue Rieussec, 78220 Viroflay, FR	22.02.2024	20.05.2034
Z20041050	34	JT International S.A., Rue Kazem-Radjavi 8, 1202 Geneva, CH	15.02.2024	30.06.2034
Z20041235	4	FUCHS LUBRICANTS CO., 17050 Lathrop Avenue, Harvey, IL 60426, US	19.02.2024	03.08.2034
Z20130488	41, 44	BIOTRENING d.o.o., 12.Podbrežje 3, 10000 Zagreb, HR		27.03.2033
Z20140202	44	Ivana Trampuš, Ilica 283, 10000 Zagreb, HR	22.01.2024	12.02.2034
Z20140221	1, 3, 5	GEUS d.o.o. za proizvodnju, trgovinu i turistička agencija, Filipovići 1G, Komin, 10383 Sveti Ivan Zelina, HR	14.02.2024	17.02.2034
Z20140227	9	OLX B.V., Symphony Offices, Gustav Mahlerplein 5, 1082 MS Amsterdam, NL	16.02.2024	18.02.2034
Z20140246	9, 38, 42	NOVATEH TERRA d.o.o., Švearova 1, 10000 Zagreb, HR		21.02.2034
Z20140249	35, 38, 41, 42	PICKBOX d.o.o., Radnička cesta 52, 10000 Zagreb, HR	13.02.2024	21.02.2034
Z20140250	35, 38, 41, 42	PICKBOX d.o.o., Radnička cesta 52, 10000 Zagreb, HR	13.02.2024	21.02.2034
Z20140255	16	TOZ PENKALA INTERNATIONAL d.o.o., Banjavčičeva 5, 10000 Zagreb, HR	14.02.2024	21.02.2034
Z20140257	16	TOZ PENKALA INTERNATIONAL d.o.o., Banjavčičeva 5, 10000 Zagreb, HR	14.02.2024	21.02.2034
Z20140278	35, 36, 45	"POSMRTNA PRIPOMOĆ", UDRUGA ZA SOLIDARNU POSMRTNU PRIPOMOĆ, Gajeva 29, 10000 Zagreb, HR	16.02.2024	26.02.2034
Z20140288	1, 31	HERBAFARM-MAGNOLIJA d.o.o., Ulica Antuna Vramca 10, 10000 Zagreb, HR	12.02.2024	27.02.2034
Z20140290	16, 35, 41, 45	HRVATSKA KOMORA DENTALNE MEDICINE, Kurelčeva 3, 10000 Zagreb, HR	23.02.2024	28.02.2034
Z20140291	1, 30, 42	IREKS AROMA d.o.o., Trešnjevka 24, 10450 Jastrebarsko, HR	19.02.2024	28.02.2034
Z20140292	1, 30, 42	IREKS AROMA d.o.o., Trešnjevka 24, 10450 Jastrebarsko, HR	19.02.2024	28.02.2034
Z20140293	1, 30, 42	IREKS AROMA d.o.o., Trešnjevka 24, 10450 Jastrebarsko, HR	19.02.2024	28.02.2034
Z20140294	1, 30, 42	IREKS AROMA d.o.o., Trešnjevka 24, 10450 Jastrebarsko, HR	19.02.2024	28.02.2034
Z20140295	1, 30, 42	IREKS AROMA d.o.o., Trešnjevka 24, 10450 Jastrebarsko, HR	19.02.2024	28.02.2034
Z20140296	5	PharmaS d.o.o. za proizvodnju i promet lijekova, Radnička 47, 10000 Zagreb, HR	27.02.2024	28.02.2034
Z20140297	5	PharmaS d.o.o. za proizvodnju i promet lijekova, Radnička 47, 10000 Zagreb, HR	27.02.2024	28.02.2034
Z20140310	3, 9, 25	MONILE d.o.o., Avenija Dubrovnik 16/7, 10000 Zagreb, HR	21.02.2024	04.03.2034
Z20140311	3, 9, 25	MONILE d.o.o., Avenija Dubrovnik 16/7, 10000 Zagreb, HR	21.02.2024	04.03.2034
Z20140318	5	BGP Products Operations GmbH, Hegenheimerattweg 127, 4123 Allschwil, CH	30.01.2024	05.03.2034
Z20140325	35, 41	Centar za management i savjetovanje d.o.o., I. Gajnički vidikovac 5, 10000 Zagreb, HR	19.02.2024	05.03.2034
Z20140334	28, 31, 44	Unconditional d.o.o., Radnička cesta 177, 10000 Zagreb, HR	04.03.2024	06.03.2034
Z20140337	35, 42	ADVERTA d.o.o., Ilica 56, 10000 Zagreb, HR	29.02.2024	07.03.2034
Z20140350	5	BGP Products Operations GmbH, Hegenheimerattweg 127, 4123 Allschwil, CH	08.02.2024	11.03.2034
Z20140352	20, 21, 29, 30, 31, 41, 42, 44	Nastavni zavod za javno zdravstvo "Dr. Andrija Štampar", Mirogojska cesta 16, 10000 Zagreb, HR	28.02.2024	11.03.2034
Z20140362	35	Langham Hotels International Limited, 33rd Floor, Great Eagle Centre, 23 Harbour Road, Wanchai, Hong Kong, CN	04.03.2024	12.03.2034
Z20140363	35	Langham Hotels International Limited, 33rd Floor, Great Eagle Centre, 23 Harbour Road, Wanchai, Hong Kong, CN	04.03.2024	12.03.2034
Z20140406	10, 25	Bauerfeind d.o.o., Goleška 20, 10020 Novi Zagreb, HR	27.02.2024	21.03.2034
Z20140407	10, 25	Bauerfeind d.o.o., Goleška 20, 10020 Novi Zagreb, HR	27.02.2024	21.03.2034
Z20140408	10, 25	Bauerfeind d.o.o., Goleška 20, 10020 Novi Zagreb, HR	27.02.2024	21.03.2034
Z20140409	10	Bauerfeind d.o.o., Goleška 20, 10020 Novi Zagreb, HR	27.02.2024	21.03.2034
Z20140410	10, 25	Bauerfeind d.o.o., Goleška 20, 10020 Novi Zagreb, HR	27.02.2024	21.03.2034
Z20140411	10, 25	Bauerfeind d.o.o., Goleška 20, 10020 Novi Zagreb, HR	27.02.2024	21.03.2034
Z20140465	5, 6, 32, 35, 43	ATLANTIC CEDEVITA d.o.o., Planinska 15, 10000 Zagreb, HR	01.03.2024	27.03.2034
Z20140511	16, 25, 35, 40	M SAN EKO d.o.o., Dugoselska ulica 5, 10372 Rugvica, HR	01.03.2024	03.04.2034
Z20140515	35, 38	Hrvatski Telekom d.d., Radnička cesta 21, 10000 Zagreb, HR	20.02.2024	04.04.2034
Z20140720	32, 35, 36, 38, 41, 43	Hrvatski Telekom d.d., Radnička cesta 21, 10000 Zagreb, HR	20.02.2024	15.05.2034
Z20140721	32, 35, 36, 38, 41, 43	Hrvatski Telekom d.d., Radnička cesta 21, 10000 Zagreb, HR	20.02.2024	15.05.2034
Z20140812	6, 11, 37, 40, 42	CENTROMETAL d.o.o., Glavna 12, 40306 Macinec, HR	13.02.2024	30.05.2034
Z20140813	6, 11, 37, 40, 42	CENTROMETAL d.o.o., Glavna 12, 40306 Macinec, HR	13.02.2024	30.05.2034
Z20141080	32, 35, 36, 38, 41, 43	Hrvatski Telekom d.d., Radnička cesta 21, 10000 Zagreb, HR	20.02.2024	31.07.2034
Z20141081	32, 35, 36, 38, 41, 43	Hrvatski Telekom d.d., Radnička cesta 21, 10000 Zagreb, HR	20.02.2024	31.07.2034

# Objava prestanka vrijednosti žigova

Broj žiga (111)	Klasifikacijska oznaka razreda (511)	Ime i adresa nositelja žiga (732)	Datum prestanka vrijednosti žiga (580)
Ž930691	5	PLIVA HRVATSKA d.o.o., Prilaz baruna Filipovića 25, 10000 Zagreb, HR	22.03.2023
Ž930761	5	Pfizer Ireland Pharmaceuticals, Operations Support Group, Ringaskiddy, County Cork, IE	25.03.2023
Ž930844	9	Arista Music, 550 Madison Avenue, New York, NY, US	29.03.2023
Ž930845	9	Arista Music, 550 Madison Avenue, New York, NY, US	29.03.2023
Ž930848	9	Sony Music Entertainment, 550 Madison Avenue, New York, NY, US	29.03.2023
Ž931059	7, 8	KAPMAN AB, 811 81 Sandviken, SE	30.03.2023
Ž931190	12	Nissan Jidosha Kabushiki Kaisha, No. 2 Takaracho, Kanagawa-ku, Yokohama-shi, Kanagawa-ken, JP	31.03.2023
Ž931192	12	Nissan Jidosha Kabushiki Kaisha, No. 2 Takaracho, Kanagawa-ku, Yokohama-shi, Kanagawa-ken, JP	31.03.2023
Ž931193	5	Zoetis Belgium, SA, 1, Rue Laid Burniat, 1348 Louvain-la-Neuve, BE	31.03.2023
Ž931233	1, 2, 17, 19	FOSROC INTERNATIONAL LIMITED, 4th Floor, 40A Dover Street, W1S 4NW London, GB	31.03.2023
Ž931240	5, 32	Krka, tovarna zdravil p.o., Cesta herojev 45, 68000 Novo Mesto, SI	31.03.2023
Ž931242	1, 5	Krka, tovarna zdravil p.o., Cesta herojev 45, 68000 Novo Mesto, SI	31.03.2023
Ž931244	5	Krka, tovarna zdravil p.o., Cesta herojev 45, 68000 Novo Mesto, SI	31.03.2023
Ž931265	9	Sony Music Entertainment, 550 Madison Avenue, New York, NY, US	01.04.2023
Ž931268	9	Sony Music Entertainment, 550 Madison Avenue, New York, NY, US	01.04.2023
Ž931330	3	Lauga SA, Place de la Gare 10, Lausanne, CH	02.04.2023
Ž931397	29, 30	CONOPCO, INC., 700 Sylvan Avenue, Englewood Cliffs, NJ 07632, US	09.04.2023
Ž931398	29, 30	CONOPCO, INC., 700 Sylvan Avenue, Englewood Cliffs, NJ 07632, US	09.04.2023
Ž931418	16	Time Inc., 225 Liberty Street, New York, NY 10281, US	09.04.2023
Ž942032	1, 4, 5, 17	Dow Corning Corporation, Midland 48686-0994, MI, US	26.03.2023
Z20030396	29, 30, 31	LEDO plus društvo s ograničenom odgovornošću za proizvodnju i promet sladoleda i smrznute hrane, Čavićeva 1a, 10000 Zagreb, HR	24.03.2023
Z20030412	29, 30	Unilever BCS Europe B.V., Weena 455, 3013 AL Rotterdam, NL	26.03.2023
Z20030413	29, 30	Unilever BCS Europe B.V., Weena 455, 3013 AL Rotterdam, NL	26.03.2023
Z20030414	5	GlaxoSmithKline Consumer Healthcare (UK) IP Limited, 980 Great West Road, Brentford, TW8 9GS Middlesex, GB	26.03.2023
Z20030420	35, 42	HENDAL, društvo s ograničenom odgovornošću za trgovinu, usluge i uvoz-izvoz, Jurja Žerjavića 13, 10000 Zagreb, HR	27.03.2023
Z20030422	9, 35, 36, 37, 42	ECS EUROCOMPUTER SYSTEMS d.o.o., Maksimirska 120, 10000 Zagreb, HR	28.03.2023
Z20030423	9, 35, 36, 37, 42, 45	ECS EUROCOMPUTER SYSTEMS d.o.o., Maksimirska 120, 10000 Zagreb, HR	28.03.2023
Z20030428	16, 41	ZEMLJIŠNA ZAJEDNICA PLEMENITA OPČINA TUROPOLJSKA, Zagrebačka 37, 10410 Velika Gorica, HR	28.03.2023
Z20030431	39	Uniglobe Travel International Limited Partnership, 1199 West Pender Street, Suite 900, Vancouver, BC V6E 2R1, CA	31.03.2023
Z20030433	5	PLIVA HRVATSKA d.o.o., Prilaz baruna Filipovića 25, 10000 Zagreb, HR	31.03.2023
Z20030434	18, 24, 25, 28, 35	TEKSTILPROMET d.d., Ul. grada Gospića 1/A, 10000 Zagreb, HR	01.04.2023
Z20030435	3, 8, 9, 14, 18, 24, 25, 28, 34, 35	TEKSTILPROMET d.d., Ul. grada Gospića 1/A, 10000 Zagreb, HR	01.04.2023
Z20030440	12	FORD MOTOR COMPANY, One American Road, Dearborn, MI 48126, US	01.04.2023
Z20030450	33	Shaw-Ross International Importers, Inc. (a Florida corporation), 1600 N.W. 163rd Street, Miami, FL, US	02.04.2023
Z20030455	33	BADEL 1862 d.d. vina, alkoholna i bezalkoholna pića, Vlaška 116, 10000 Zagreb, HR	02.04.2023
Z20030456	33	BADEL 1862 d.d. vina, alkoholna i bezalkoholna pića, Vlaška 116, 10000 Zagreb, HR	02.04.2023
Z20030458	3	Church & Dwight Co., Inc., 500 Charles Ewing Boulevard, Ewing, NJ 08628, US	03.04.2023
Z20030459	3	Church & Dwight Co., Inc., 500 Charles Ewing Boulevard, Ewing, NJ 08628, US	03.04.2023
Z20030462	29	Ivica Ančić, Radovanova 8, 21000 Split, HR	03.04.2023
Z20030464	29, 31	Thai Union Manufacturing Company Limited, 979/13-16, M.Floor, S.M. Tower, Phaholyothin Road, Samsennai, Phayathai, 10400 Bangkok, TH	03.04.2023
Z20030511	35, 36, 37	ZAGREBAČKI VELESAJAM d.o.o., Avenija Dubrovnik 15, 10020 Zagreb, HR	03.04.2023

## HR - Hrvatski glasnik intelektualnog vlasništva 31, 6/2024 - ŽIGOVI

Broj žiga (111)	Klasifikacijska oznaka razreda (511)	Ime i adresa nositelja žiga (732)	Datum prestanka vrijednosti žiga (580)
Z20030522	35, 36, 37	ZAGREBAČKI HOLDING d.o.o. - PODRUŽNICA ZAGREBAČKI VELESAJAM, Ulica grada Vukovara 41 (adresa podružnice Avenija Dubrovnik 15), 10000 Zagreb, HR	03.04.2023
Z20030534	1	STRNAD HOLDING d.o.o., Bana Josipa Jelačića 2/A, Mačkovec, 40000 Čakovec, HR	03.04.2023
Z20030535	30, 32, 39, 42	DON DON proizvodno in trgovsko podjetje d.o.o., Gasilska cesta 2, 1290 Grosuplje, SI	04.04.2023
Z20030546	30	P.T.U.U.O. Babić, vl. Ivica Babić, Kopilica 19, 21000 Split, HR	03.04.2023
Z20030548	30	P.T.U.U.O. Babić, vl. Ivica Babić, Kopilica 19, 21000 Split, HR	05.04.2023
Z20030552	11	Electrolux Professional AB, S:t Göransgatan 143, 112 17 Stockholm, SE	07.04.2023
Z20030554	11	Electrolux Professional AB, S:t Göransgatan 143, 112 17 Stockholm, SE	07.04.2023
Z20030555	36	MasterCard International Incorporated, a Delaware corporation, 2000 Purchase Street, Purchase, 10577-2509, NY, US	07.04.2023
Z20121616	30	ANALITIK PLUS d.o.o., G. Kalčića 10, 52440 Poreč, HR	05.04.2023
Z20121617	30	ANALITIK PLUS d.o.o., G. Kalčića 10, 52440 Poreč, HR	05.04.2023
Z20130279	16	Miki Bratanić, UDRUGA KONOBA, D. Šimunovića 9, 21000 Split, HR	21.03.2023
Z20130447	35, 38	VIPnet d.o.o., Vrtni put 1, 10000 Zagreb, HR	21.03.2023
Z20130448	35, 41, 42, 44	Ana Popović Kišur, Između polača 12, 20000 Dubrovnik, HR	21.03.2023
Z20130449	35, 43	Ana Popović Kišur, Između polača 12, 20000 Dubrovnik, HR	21.03.2023
Z20130450	21	Fiskars UK Limited, Wedgwood Drive, Barlaston, Stoke-on-Trent, ST12 9ER Staffordshire, GB	21.03.2023
Z20130451	29, 30, 33	Ivana Tolj, Gramača 2R, 10000 Zagreb, HR	22.03.2023
Z20130452	29, 30, 33	Ivana Tolj, Gramača 2R, 10000 Zagreb, HR	22.03.2023
Z20130453	29, 30, 33	Ivana Tolj, Gramača 2R, 10000 Zagreb, HR	22.03.2023
Z20130454	29, 30, 33	Ivana Tolj, Gramača 2R, 10000 Zagreb, HR	23.03.2023
Z20130459	25, 35, 42	Andela Pavleka, Vebera Tkalčevića 10, 10040 Zagreb, HR	22.03.2023
Z20130465	9	Samsung Electronics Co., Ltd., 129, Samsung-ro, Yeongtong-gu, Suwon-si, Gyeonggi-do, KR	22.03.2023
Z20130470	35, 39, 41, 44	Klaster Medicinskog Turizma d.o.o., Ulica Ćirila i Metoda 2, 22211 Vodice, HR	25.03.2023
Z20130472	3, 5, 10, 21	GlaxoSmithKline Consumer Healthcare (UK) IP Limited, 980 Great West Road, Brentford, TW8 9GS Middlesex, GB	25.03.2023
Z20130474	5	NIPPON KAYAKU KABUSHIKI KAISHA, 11-2, Fujimi 1-chome, Chiyoda-ku, Tokyo, JP	26.03.2023
Z20130477	25, 35, 41	Damir Duplančić, Poljička cesta 14, 21000 Split, HR	26.03.2023
Z20130478	31, 32, 33	ALFA CONSILIUM d.o.o., Ljudevita Gaja 38, 31325 Čeminac, HR	26.03.2023
Z20130480	12, 35, 37, 39	T.R.C.Z.-AUTOSERVIS d.o.o., Zagrebačka 118, 10360 Sesvete, HR	27.03.2023
Z20130481	9, 37, 45	SKYLINK društvo s ograničenom odgovornošću za usluge zaštite osoba i imovine, Jure Kaštelana 19, 10000 Zagreb, HR	27.03.2023
Z20130482	9, 37, 45	SKYLINK društvo s ograničenom odgovornošću za usluge zaštite osoba i imovine, Jure Kaštelana 19, 10000 Zagreb, HR	27.03.2023
Z20130483	11, 37, 45	SKYLINK društvo s ograničenom odgovornošću za usluge zaštite osoba i imovine, Jure Kaštelana 19, 10000 Zagreb, HR	27.03.2023
Z20130484	11, 37, 45	SKYLINK društvo s ograničenom odgovornošću za usluge zaštite osoba i imovine, Jure Kaštelana 19, 10000 Zagreb, HR	27.03.2023
Z20130485	10, 39, 44	Branko Grahovac, Dvorničićeva 21, 10000 Zagreb, HR	27.03.2023
Z20130489	14, 16, 18, 21, 25, 28	Andrea Cmrečki, Petrinjska ul. 45, 10000 Zagreb, HR	27.03.2023
Z20130491	35, 36, 37	SOLEO MEDIA d.o.o., 2. Ravnice 29, 10000 Zagreb, HR	28.03.2023
Z20130494	5	PLIVA HRVATSKA d.o.o., Prilaz baruna Filipovića 25, 10000 Zagreb, HR	26.03.2023
Z20130498	35, 37, 39, 41, 42, 43, 45	GRAD RIJEKA, Korzo 16, 51000 Rijeka, HR	26.03.2023
Z20130505	35, 41, 45	Margita Soldo, Šljivarska 31, 10000 Zagreb, HR	28.03.2023
Z20130506	9, 16, 18	Elizabeta Novaković, Augusta Šenoa 17a, Brezje, 10431 Sveta Nedelja, HR	29.03.2023
Z20130507	35, 36, 41	FISCALIS društvo s ograničenom odgovornošću za računovodstvo i usluge, Radnička cesta 80, 10000 Zagreb, HR	29.03.2023
Z20130509	18, 25, 35	Moja štikla d.o.o., Školski prilaz 1, 10000 Zagreb, HR	28.03.2023
Z20130510	3, 5, 24, 25	TAXO d.o.o., Trg Kralja Tomislava 3, 47250 Duga Resa, HR	29.03.2023
Z20130514	14, 16, 19, 20, 21	Saša Matjašić, Istarska 7, 52100 Pula, HR	28.03.2023
Z20130515	9, 16	UNEX GRUPA d.o.o., Ilica 26, 10000 Zagreb, HR	02.04.2023
Z20130516	33	Ante Biliš, Žrnovo 607, 20275 Žrnovo, HR	29.03.2023
Z20130518	33	Ante Grabovac, Grašćica 6a, 10000 Zagreb, HR	02.04.2023
Z20130519	29, 30, 31	Farmaceutska Hemijaska Kozmetička industrija ALKALOID AD - Skopje, Bul. Aleksandar Makedonski br.12, 1000 Skopje, MK	02.04.2023
Z20130520	29, 30, 31	Farmaceutska Hemijaska Kozmetička industrija ALKALOID AD - Skopje, Bul. Aleksandar Makedonski br.12, 1000 Skopje, MK	02.04.2023
Z20130521	29, 30, 31	Farmaceutska Hemijaska Kozmetička industrija ALKALOID AD - Skopje, Bul. Aleksandar Makedonski br.12, 1000 Skopje, MK	02.04.2023
Z20130531	34	British American Tobacco (Brands) Inc., 251 Little Falls Drive, Suite 100, Wilmington, DE 19808-1674, US	03.04.2023
Z20130533	12	GENERAL MOTORS LLC, 300 Renaissance Center, City of Detroit, MI 48265-3000, US	04.04.2023

Broj žiga (111)	Klasifikacijska oznaka razreda (511)	Ime i adresa nositelja žiga (732)	Datum prestanka vrijednosti žiga (580)
Z20130537	5	Farmaceutska Hemijska Kozmetička industrija ALKALOID AD - Skopje, Bul. Aleksandar Makedonski br.12, 1000 Skopje, MK	04.04.2023
Z20130538	34	British American Tobacco (Brands) Inc., 251 Little Falls Drive, Suite 100, Wilmington, DE 19808-1674, US	04.04.2023
Z20130539	36	Bank of America Corporation, 100 North Tryon Street, Charlotte, NC 28255, US	04.04.2023
Z20130540	12	TOYOTA JIDOSHA KABUSHIKI KAISHA (also trading as TOYOTA MOTOR CORPORATION), 1, Toyota -cho, Toyota-shi, Aichi-ken, JP	04.04.2023
Z20130543	9	Western Digital Technologies, Inc., 3355 Michelson Drive, Suite 100, Irvine, CA 92612, US	04.04.2023
Z20130547	36	Bank of America Corporation, 100 North Tryon Street, Charlotte, NC 28255, US	05.04.2023
Z20130548	34	Philip Morris Brands Sàrl, Quai Jeanrenaud 3, 2000 Neuchâtel, CH	05.04.2023
Z20130551	41, 43	Žarko Dešković, Ban Mladena 2, 21000 Split, HR	08.04.2023
Z20130552	5	RB Health (US) LLC, 399 Interpace Parkway, Parsippany, NJ 07054, US	08.04.2023
Z20130553	29	Sanja Zlatar, Ulica grada Vukovara 239/A, 10000 Zagreb, HR	08.04.2023
Z20130554	9, 16, 35, 36, 38, 39, 42	MasterCard International Incorporated, 2000 Purchase Street, Purchase, New York, NY 10577, US	08.04.2023
Z20130562	29, 30, 31, 32, 35	Siniša Levaković, Savska 9, 31000 Osijek, HR	08.04.2023



# Objava registracija industrijskih dizajna

(51) **LOC (14) Cl. 11-02**

(21) D20240008A

(54) **UKRASNI PREDMET**

(72)(73) Tomislav Cvetko, Lomnička 89, 10410 Velika Gorica, HR

(55)

(11) **D20240008**

(15) 05.03.2024

(22) 29.01.2024



(51) **LOC (14) Cl. 15-09**

(21) D20230082A

(54) **ALATNI STROJEVI ZA METAL**

(73) HS Produkt d.o.o., Ul. Mirka Bogovića 7, 47000 Karlovac, HR

(72) Zvonimir Fudurić, Kneza Trpimira 1, 47000 Karlovac, HR

(74) Tomislav Hadžija, Zagreb, HR

(55)

(11) **D20230082-1**

(15) 05.03.2024

(22) 30.08.2023

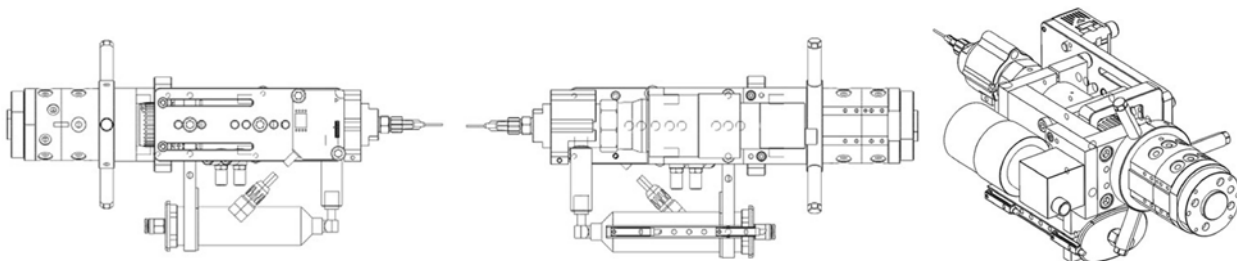

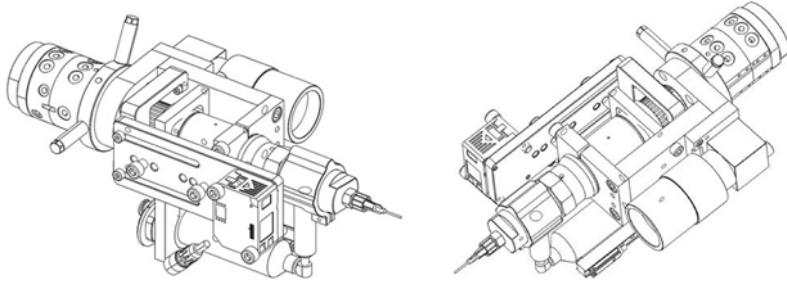

(51) **LOC (14) Cl. 15-09**

(21) D20230082A

(54) **ALATNI STROJEVI ZA METAL**

(73) HS Produkt d.o.o., Ul. Mirka Bogovića 7, 47000 Karlovac, HR

(72) Mario Erceg, Kneza Trpimira 3, 47000 Karlovac, HR

(74) Tomislav Hadžija, Zagreb, HR

(55)

(11) **D20230082-2**

(15) 05.03.2024

(22) 30.08.2023

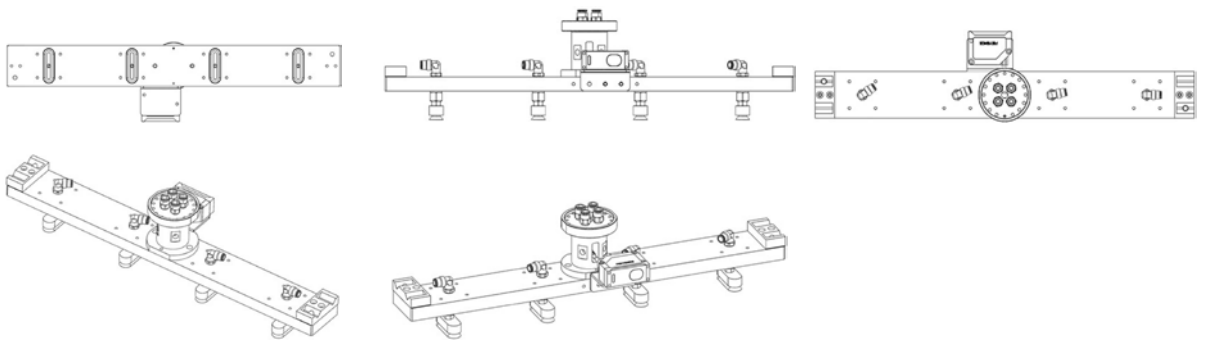

(51) **LOC (14) Cl. 29-01**

(21) D20240010A

(54) **PROTUPOŽARNI UREĐAJ**

(73) Pastor TVA d.d., Novačka 2, 10437 Rakitje, HR

(72) Branko Dautović, Ulica Josipa Marohnića 8, 10000 Zagreb, HR

(55)

(11) **D20240010**

(15) 01.03.2024

(22) 01.02.2024

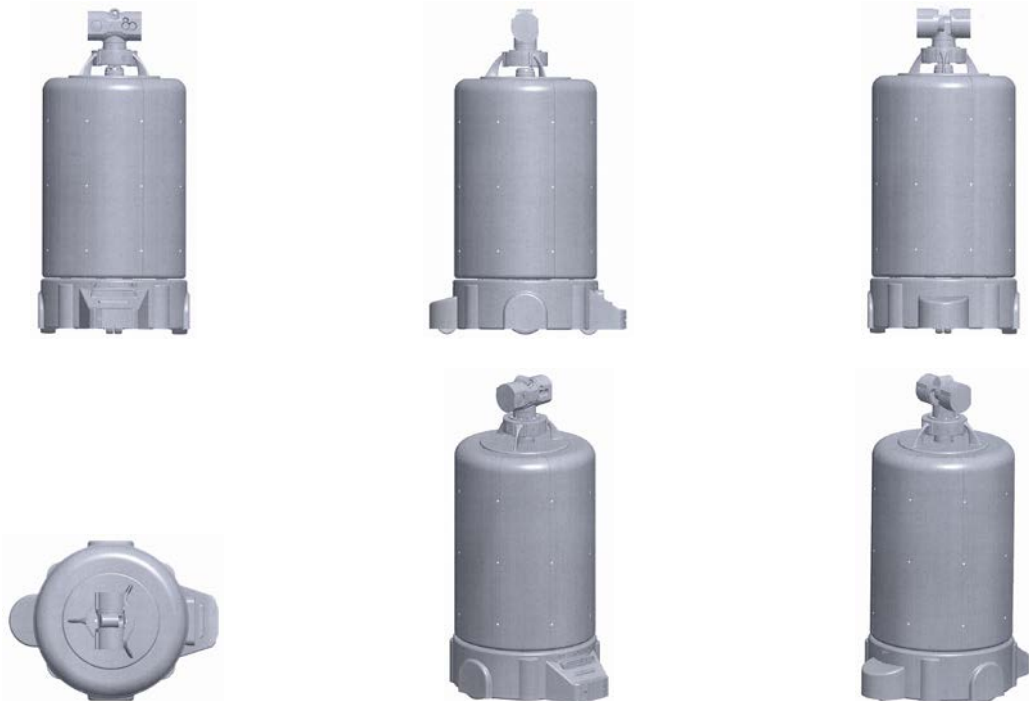

(51) **LOC (14) Cl. 32-00**

(11) **D20240007**

(21) D20240007A

(15) 28.02.2024

(54) **GRAFIČKI DIZAJN [DVIDIMENZIONALNI]**

(22) 19.01.2024

(73) Jasen Brajlović, A. K. Miošića 6, 20340 Ploče, HR

(72) Ivo Brajlović, A.K. Miošića 6, 20340 Ploče, HR

(55)



# Kazalo brojeva industrijskih dizajna

Broj ind. dizajna (11)	LOC razred i podrazred (51)	Broj ind. dizajna (11)	LOC razred i podrazred (51)
D20230082-1	15-09	D20240008	11-02
D20230082-2	15-09	D20240010	29-01
D20240007	32-00		

# Kazalo klasifikacijskih oznaka industrijskih dizajna

LOC razred i podrazred (51)	Broj ind. dizajna (11)	Nositelj industrijskog dizajna (73)
11-02	D20240008	Tomislav Cvetko, Lomnička 89, 10410 Velika Gorica, HR
15-09	D20230082-1	HS Produkt d.o.o., Ul. Mirka Bogovića 7, 47000 Karlovac, HR
15-09	D20230082-2	HS Produkt d.o.o., Ul. Mirka Bogovića 7, 47000 Karlovac, HR
29-01	D20240010	Pastor TVA d.d., Novačka 2, 10437 Rakitje, HR
32-00	D20240007	Jasen Brajlović, A. K. Miošića 6, 20340 Ploče, HR

# Kazalo nositelja industrijskih dizajna

Nositelj industrijskog dizajna (73)	LOC razred i podrazred (51)	Broj ind. dizajna (11)
Jasen Brajlović, A. K. Miošića 6, 20340 Ploče, HR	32-00	D20240007
Tomislav Cvetko, Lomnička 89, 10410 Velika Gorica, HR	11-02	D20240008
HS Produkt d.o.o., Ul. Mirka Bogovića 7, 47000 Karlovac, HR	15-09	D20230082-1
HS Produkt d.o.o., Ul. Mirka Bogovića 7, 47000 Karlovac, HR	15-09	D20230082-2
Pastor TVA d.d., Novačka 2, 10437 Rakitje, HR	29-01	D20240010

# Objava produženja vrijednosti registriranih industrijskih dizajna

Broj ind. dizajna	Ime(na) i adresa(e) nositelja industrijskog dizajna	Datum podnošenja zahtjeva za produženje vrijednosti industrijskog dizajna	Datum do kojeg vrijedi produženje vrijednosti industrijskog dizajna (18)
(11)	(73)		
D20040093-1	ADRIA WINCH d.o.o., Mostine 11b, 21000 Split, HR	29.02.2024	26.03.2029
D20040093-2	ADRIA WINCH d.o.o., Mostine 11b, 21000 Split, HR	29.02.2024	26.03.2029
D20090045	DW REUSABLES d.o.o., Kupljensko 75B, 47220 Vojnić, HR	08.03.2024	09.03.2029
D20090050	Dines duo d.o.o., Rimski put 22, 10360 Sesvete, HR	28.02.2024	16.03.2029
D20090051	Karla Brstilo, Alojzija Stepinca 9, 21000 Split, HR	08.03.2024	18.03.2029
D20140034-1	HRVATSKI NOGOMETNI SAVEZ, Ulica grada Vukovara 269a, 10000 Zagreb, HR	28.02.2024	28.02.2029
D20140034-2	HRVATSKI NOGOMETNI SAVEZ, Ulica grada Vukovara 269a, 10000 Zagreb, HR	28.02.2024	28.02.2029
D20140043-1	Silvio Lončarić, Špansko 26, 10090 Zagreb, HR	01.03.2024	11.03.2029
D20140043-2	Silvio Lončarić, Špansko 26, 10090 Zagreb, HR	01.03.2024	11.03.2029
D20140043-3	Silvio Lončarić, Špansko 26, 10090 Zagreb, HR	01.03.2024	11.03.2029
D20140059	STRIBOR OPREMA d.o.o., Dekanj Peti 10, 31327 Kopačevo-Bilje, HR	26.03.2024	24.03.2029
D20140071	Igor Ignac, Zatišje 6A, 10000 Zagreb, HR Vanja Nikolac, Našička 15, 10000 Zagreb, HR	01.03.2024	18.04.2029
D20190024	Toma Cirimotić, Vinodolska 30, 10000 Zagreb, HR	27.02.2024	14.03.2029
D20190033-1	Silvio Budicin, Domenico Medelin 10, 52210 Rovinj, HR	01.03.2024	27.03.2029
D20190033-2	Silvio Budicin, Domenico Medelin 10, 52210 Rovinj, HR	01.03.2024	27.03.2029
D20190033-3	Silvio Budicin, Domenico Medelin 10, 52210 Rovinj, HR	01.03.2024	27.03.2029
D20190033-4	Silvio Budicin, Domenico Medelin 10, 52210 Rovinj, HR	01.03.2024	27.03.2029

# Objava prestanka vrijednosti priznatih prava

Broj modela/uzorka ili ind. oblička (11)	Ime(na) i adresa(e) nositelja prava (73)	Datum prestanka vrijednosti (58)	Priznato pravo objavljeno u HGIV-u br.
D20030139-1	HENKEL KOMMANDITGESELLSCHAFT AUF AKTIEN, Henkelstrasse 67, 40589 Duesseldorf, DE	12.08.2023	6/2004
D20030139-2	HENKEL KOMMANDITGESELLSCHAFT AUF AKTIEN, Henkelstrasse 67, 40589 Duesseldorf, DE	12.08.2023	6/2004
D20030139-3	HENKEL KOMMANDITGESELLSCHAFT AUF AKTIEN, Henkelstrasse 67, 40589 Duesseldorf, DE	12.08.2023	6/2004
D20030139-4	HENKEL KOMMANDITGESELLSCHAFT AUF AKTIEN, Henkelstrasse 67, 40589 Duesseldorf, DE	12.08.2023	6/2004
D20180100	Igor Mladinović, Ede Peročevića 12, 10010 Zagreb, HR	14.08.2023	22/2018
D20180108	Filozofski fakultet Sveučilišta u Zagrebu, I. Lučića 3, 10000 Zagreb, HR	30.08.2023	25/2018



# Informacije o objavama međunarodnih registracija industrijskog dizajna s učinkom u Republici Hrvatskoj

---

International Designs Bulletin  
Bulletin 2023/38 (22. rujna 2023)

---

(11) **231505**  
(15)  
(22) 04.08.2023  
(73) Volkswagen Aktiengesellschaft, Berliner Ring 2, 38440 Wolfsburg (DE)  
(86) DE  
(87) DE  
(88) DE  
(28) 3  
(51) Cl. 26-06  
(54) 1. Rear light for vehicles/Feu arrière pour véhicules; 2. Rear light for  
vehicles/Feu arrière pour véhicules; 3. Rear light for vehicles/Feu arrière pour  
véhicules

**Objava podataka iz Registra zastupnika u službenom glasilu Zavoda (Glasnik) u skladu s čl. 16. Zakona o zastupanju**

**Registarski broj ovlaštenog zastupnika: [ZA20240223](#)**

**Naziv tvrtke, sjedište/ podaci o fizičkoj osobi koja zadovoljava uvjete za zastupanje pred Zavodom:**

**SVJETSKA UDRUGA INTELEKTUALNIH VLASNIKA - SUIV**

**Ulica kneza Branimira 47**

**10000 Zagreb**

**Hrvatska**

**tel: +442033987920**

**e-mail: [info@worldassociationofintellectualowners.com](mailto:info@worldassociationofintellectualowners.com)**

**Datum upisa u Registar zastupnika za žigove: [4.3.2024.](#)**

**Objava podataka iz Registra zastupnika u službenom glasilu Zavoda (Glasnik) u skladu s čl. 16. Zakona o zastupanju**

**Registarski broj ovlaštenog zastupnika: **ZA20210206****

**Naziv tvrtke, sjedište/ podaci o fizičkoj osobi koja zadovoljava uvjete za zastupanje pred Zavodom:**

**Odvjetnica Natalija Labavić**  
**Jelenovac 38 E**  
**10000 Zagreb**  
**Hrvatska**  
**tel: 091/5168-386**  
**e-mail: [natalija@labavic.com](mailto:natalija@labavic.com)**

**Datum upisa promjene u Registar: **6.3.2024.****